

NOTICE

NFT · TFN · TFT series FERRITE CLAMP Changes to Material of Casing

■ Affected series / models

Product No.	Product No.
NFT-4	TFN-081610
NFT-6	TFN-081813
NFT-8	TFN-102010
NFT-12	TFN-112514
TFT-274015S	TFN-152613

■ Change : Material of Casing

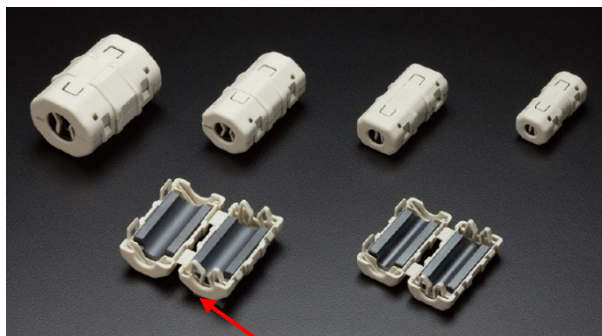

Casing

Current Material: PA66 UL94V-0 ➔ **New Material : PA66 and PA6 UL94V-0**

- Slight color difference may exist by material.
- Functionality: No changes to functionality, size / dimensions, or finish.
- Purpose: To ensure consistent quality throughout via streamlined supply chain and materials.
- Period: Once current inventory has been depleted.
- Series / Model: No changes to Series, Product number, or pricing.

Thank you for your understanding.

For more information, kindly contact us at: sales@takachi-el.co.jp

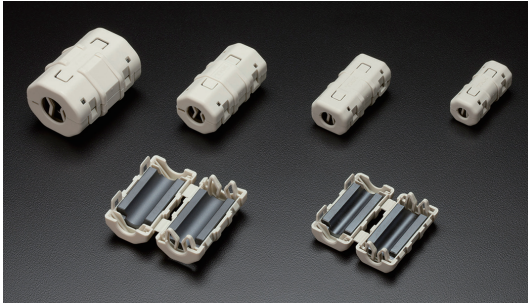

Impedance characteristics

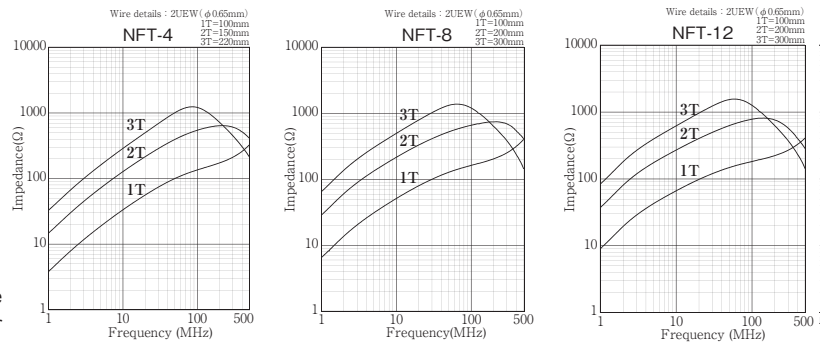

- For environmental measures, a clean ferrite core material free of harmful substances are used. (See page TFB · FBS-1 for the details.)
- Casing is made using halogen-free PA66 (UL94V-0) material.
- The cable holder is designed in such a way that there will be no damage to the cables when the case is closed.
- The cable holder has a cable punch prevention function to prevent loose wires from being clamped when the case is closed.
- Affordably priced yet being environmentally friendly.

Components

Part name	Pcs	Material	Color
Casing	1	PA66 (UL94V-0)	Light gray
Split sleeve core	1 set	Clean ferrite	Gunmetal

Product no. / Dimensions

Product no.	A	B	C	Min. impedance (Ω)		Max. cable diameter
				25MHz	100MHz	
NFT- 4	13.7	12.9	29.9	75	155	~Φ 4.5
NFT- 6	17.8	15	35.9	100	182	~Φ 6.5
NFT- 8	21.2	20.8	39.1	95	190	~Φ 8.5
NFT-12	31.7	27.9	42	100	190	~Φ12.5

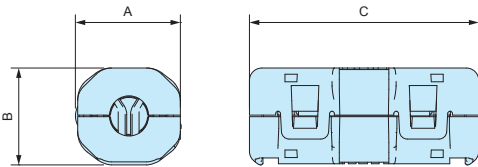

- Impedance values at 1T is shown. Actual measurement data is available for reference.
- Please note that impedance varies based on wire diameter, number of turns, magnetic saturation, and other factors.



Impedance characteristics

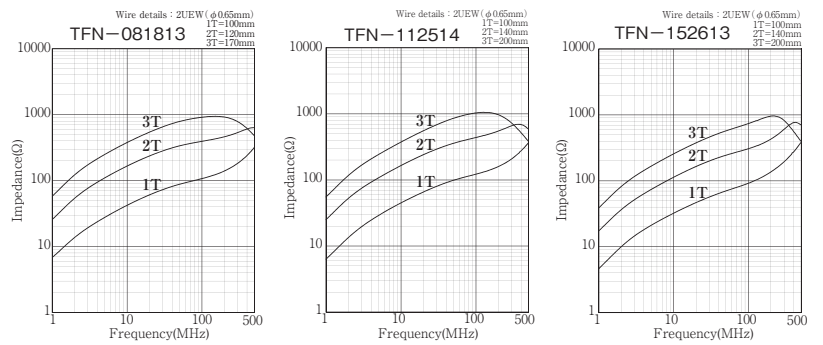

- For environmental measures, a clean ferrite core material free of harmful substances are used. (See page TFB · FBS-1 for the details.)
- Casing is made using halogen-free PA66 (UL94V-0) material.
- Simple, space-saving construction with optional fittings for installation onto equipment.
- Optional fittings are available in both screw type and adhesive tape type.
- Integrated cable tie band holder allows for easy securing of cable (not available for TFT-274015S model).
- Affordably priced yet being environmentally friendly.

Components

Part name	Pcs	Material	Color
Casing	1	PA66 (UL94V-0)	Light gray
Split toroidal core	1 set	Clean ferrite	Gunmetal

Product no. / Dimensions

Product no.	A	B	C	D	E	Min. impedance (Ω)		Max. cable diameter
						25MHz	100MHz	
NEW TFN-081610	19.2	7.6	15.1	16.6	19.7	44	82	~Φ 7.5
NEW TFN-081813	21.7	8	18	20.1	22.5	66	120	~Φ 7.5
NEW TFN-102010	24.1	9.9	15	16.8	19.6	46	90	~Φ 8.8
NEW TFN-112514	28.7	11.4	20.2	21.9	25.2	73	125	~Φ10.8
NEW TFN-152613	30	15	19.2	21	24.3	52	92	~Φ13.5
TFT-274015S	43.8	27.4	20.7	-	-	40	75	~Φ26.5

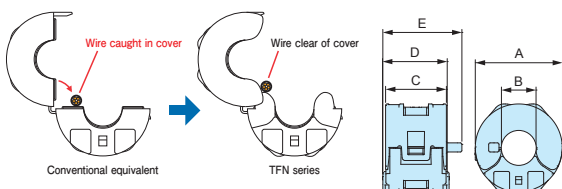

- Impedance values at 1T is shown. Actual measurement data is available for reference.
- Please note that impedance varies based on wire diameter, number of turns, magnetic saturation, and other factors.
- TFT-274015S cannot be attached to optional fittings.

TFB SERIES

FITTING for ONE-TOUCH SPLIT TOROIDAL CORE FERRITE CLAMP

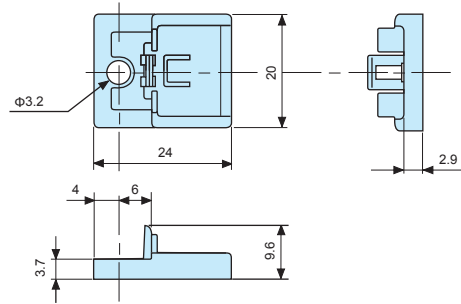
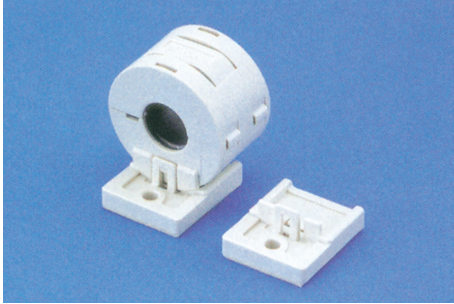

How to assemble

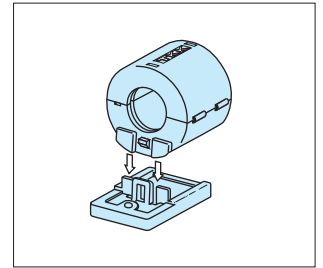

Fitting (Screw Type and Adhesive Tape Type)

- Fittings can be easily attached or detached with a single touch. Once installed, it is resistant against multi-directional forces.
- Compact, space-saving construction to minimize overall dimensions.
- Fitting can be installed onto case with cables clamped. Case can be opened/closed without removal of the fitting.
- Compatible with TFN series clamp cores.

Product no.

Product no.	Type
TFB-2024M3	M3 screw type
TFB-2024A	t1.0 adhesive tape type

- Material / Color : PA66 (UL94V-0) / Gray

FBS-1T

CABLE TIE HOLDER for TFT-274015S

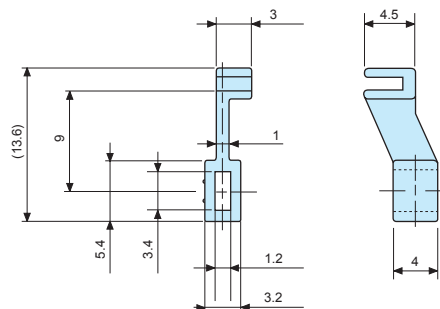
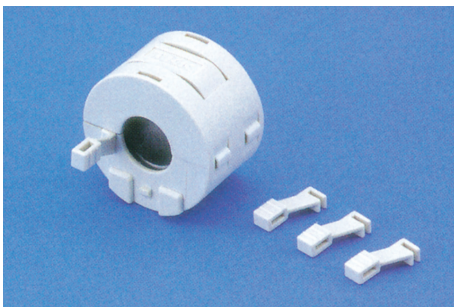

How to assemble

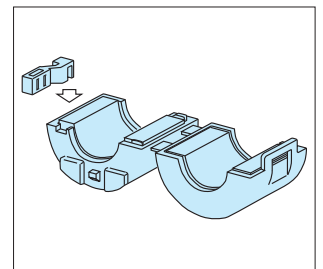

Cable Tie Holder

- Cable tie holder for clamping cables onto TFT core.
- Usable by either method of first attaching to the wiring cable, or attaching to the core case.
- Easy installation - simply by inserting it into the case notch.
- Compatible with TFT-274015S model.

Product no.

Product no.	Type
FBS-1T	Cable tie holder

- Material / Color : PA66 (UL94V-0) / Gray

CLEAN FERRITE CORE

■ Due to the increase in global environmental protection in recent years, there is an active movement to regulate the use of toxic and harmful substances in the natural environment and the human body. In particular, the governments and industries of Europe and the United States are promptly promoting the reduction of environmentally hazardous substances. Also in Japan, the elution of environmentally destructive substances from industrial waste treatment plants has become a major problem.

CHARACTERISTICS

- Ferrite material with noise attenuation characteristics is used in a wide frequency band.
- Impedance characteristics are not much different from conventional products.

REMOVED HARMFUL SUBSTANCES

The clean ferrite core does not contain any of the following harmful substances.

EACEM Regulation Ferrite Core	Cadmium / its compound Regulated	Cobalt / its compound Regulated	Nickel / its compound Regulated	Manganese / its compound Regulated
Clean Ferrite Core	No	No	No	No
NiZn Ferrite Core	No	No	Contains	No
MnZn Ferrite Core	No	No	No	Contains