

SG SERIES

RUBBER MEMBRANE GROMMET

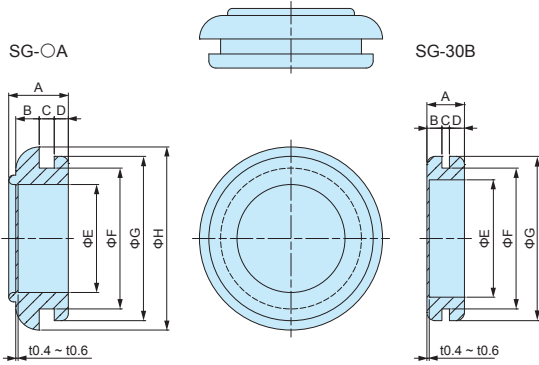

■ DXF/DWG/PDF drawings available on our website.



Technical Data

Operating temperature: -30°C ~ +100°C

Components

Material	Hardness	Color
EPDM	55°±5°	Black

■ Membrane thickness = 0.4 ~ 0.6mm

Product no. / Dimensions

Product no.	A	B	C	D	E	F	G	H	Pack of
SG- 9A	8.5	3.5	2.3	2	4.5	9	13	16	10
SG-12A	6.3	2.5	1.6	1.5	7	12	16	19	10
SG-14A	8	2.7	2.3	2	9	14	18	21	10
SG-16A	8.1	3.5	1.6	2	11	16	20	23	10
SG-18A	8.8	3.5	2.3	2	13	18	22	25	10
SG-20A	9.1	4	1.6	2.5	15	20	24	27	10
SG-22A	9.8	4	2.3	2.5	17	22	26	29	10
SG-24A	11.3	5	2.3	3	19	24	28	31	10
SG-26A	12.2	5	3.2	3	19	26	31	35	10
SG-28A	11.8	5	2.3	3	21	28	33	37	10
SG-30A	12.7	5	3.2	3	23	30	35	39	10
SG-30B	8	3.2	1.6	3.2	25	30	35	—	10
SG-32A	11.8	5	2.3	3	25	32	37	41	10
SG-34A	12.7	5	3.2	3	27	34	39	43	10
SG-36A	13.8	6	2.3	4	28	36	42	45	10
SG-38A	14.7	6	3.2	4	30	38	44	48	10
SG-42A	14.7	6	3.2	4	34	42	48	52	10

NG SERIES

RUBBER GROMMET



■ DXF/DWG/PDF drawings available on our website.

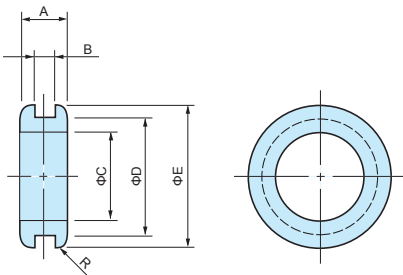

Technical Data

Operating temperature: -30°C ~ +100°C

Components

Material	Hardness	Color
EPDM	50° ~ 55°	Black

Product no. / Dimensions

Product no.	A	B	C	D	E	R	Pack of
NG-79-1	3.7	1.2	3.5	6	9	0.6	10
NG-79-A1	4	1	5	8	11	0.6	10
NG-79-A	4.5	1.5	5	8	11	0.6	10
NG-79-A2	5	2	5	8	11	0.6	10
NG-79-B	6	3	5	8	11	0.6	10
NG-79-C	4.5	1.5	7	10	13	0.6	10
NG-79-D	6	3	7	10	13	0.6	10
NG-79-E	4.5	1.5	9	12	15	0.6	10
NG-79-F	6	3	9	12	15	0.6	10
NG-79-G	5.5	1.5	11	15	19	1	10
NG-79-H	7	3	11	15	19	1	10
NG-79-J	5.5	1.5	13	17	21	1	10
NG-79-K	7	3	13	17	21	1	10
NG-79-L	5.5	1.5	15	19	23	1	10
NG-79-M	7	3	15	19	23	1	10
NG-79-N	6.5	1.5	20	25	30	1.2	10
NG-79-O	8	3	20	25	30	1.2	10
NG-79-P	6.5	1.5	25	30	35	1.2	10
NG-79-Q	8	3	25	30	35	1.2	10
NG-79-R	7.5	1.5	30	36	42	1.2	10
NG-79-S	9	3	30	36	42	1.2	10
NG-74	4	1	3	5	7	1	10
NG-742	5	2	3	5	7	1	10

**MHD SERIES**

**SMALL HOLE PLUG**



■ DXF/DWG/PDF drawings available on our website.

- Small hole plug for  $\Phi 5.0$ ,  $\Phi 5.5$ ,  $\Phi 7.0$ , and  $\Phi 8.0$  sized holes.
- Made from TPE (Elastomer) and silicone material.
- Applicable panel installation thickness between 1.0mm ~ 3.0mm.

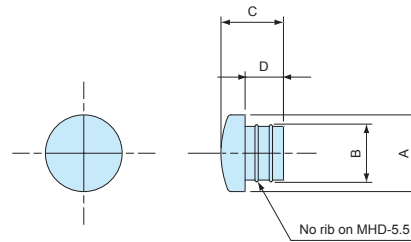

**Product no. / Dimensions**

Product no.	Material	Color	Mounting hole	A	B	C	D	Pack of
MHD-5	TPE	Black	$\Phi 5$	7	5.2	5.7	3.5	10
MHD-5.5	Silicone	Black	$\Phi 5.5$	7	5.6	5	3	10
MHD-7	TPE	Black	$\Phi 7$	9	7.2	5.7	3.5	10
MHD-8	TPE	Black	$\Phi 8$	10	8.2	5.7	3.5	10

**HPL SERIES**

**HOLE PLUG**



- Hole plug for the unused holes.

■ DXF/DWG/PDF drawings available on our website.

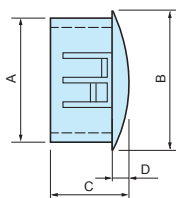

**Product no. / Dimensions**

■ Material / Color : PA66 UL94V-2 / Black

Product no.	A	B	C	D	Mounting hole	Panel thickness	Pack of
HPL- 8	7.6	10.4	8.1	1.6	$\Phi 8$	1.5/1.6	10
HPL-10	9.5	13	10.5	1.6	$\Phi 9.5$	1.0/2.0/2.5	10
HPL-13	12.5	16.7	10.9	1.6	$\Phi 12.5$	1.0/1.5/2.0/3.0	10
HPL-16	15.8	19.8	10	1.1	$\Phi 16$	1.0/1.2/3.0	10
HPL-19	18.9	23.2	10	1.4	$\Phi 19$	1.0/1.2	10
HPL-22	22	26	11.3	1.6	$\Phi 22$	1.0/1.2/2.0	10
HPL-25	25.4	29.1	12.3	2.4	$\Phi 25.5$	1.0/1.2/2.0	10
HPL-30	30	35	12	1.6	$\Phi 30$	1.0/1.2/2.0	10

■ Confirm first for usability on panel thickness not listed in the above chart.

**JKG SERIES**

**HOLE EDGE PROTECTOR**

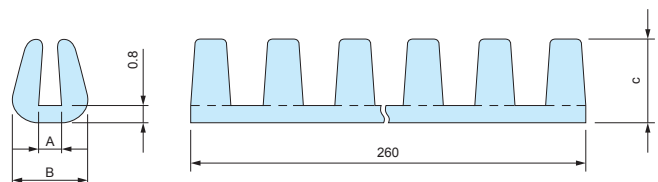

- Install protector on the cut edge of the hole on the panel to protect cables and components from damage.
- Cut into suitable lengths to fit the hole.

**Product no. / Dimensions**

■ Material / Color : PA66 UL94V-2 / Natural

Product no.	A	B	C	Panel thickness	Pack of
JKG006N	0.6	3.1	3.8	0.5 ~ 0.7	10
JKG008N	0.8	3.1	3.8	0.7 ~ 0.9	10
JKG010N	1	3.3	3.8	0.9 ~ 1.1	10
JKG012N	1.2	3.5	3.8	1.1 ~ 1.3	10
JKG014N	1.4	3.7	3.8	1.3 ~ 1.5	10
JKG016N	1.6	3.9	3.8	1.4 ~ 1.7	10
JKG020N	2	4.3	3.8	1.8 ~ 2.0	10
JKG030N	3	6.2	4.8	2.5 ~ 3.0	10

CP SERIES

CORD PROTECTOR

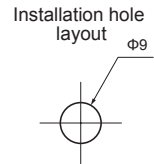
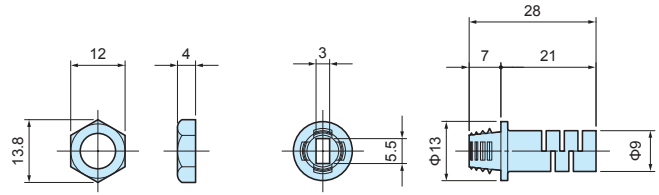

- Cord protector for protection against cord twists and breakage.
- Nut can be secured from the back side of the panel for additional stability.

Components

No.	Part name	Material
1	Connector	PVC
2	Nut	Polyethylene

Product no. / Feature

Product no.		Panel thickness	Cord diameter	Pack of
● Black	● Light Gray			
CP-Y85B	CP-Y85G	1.5 ~ 2.0	VFF0.75×2	10

CP SERIES

CORD PROTECTOR

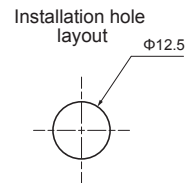
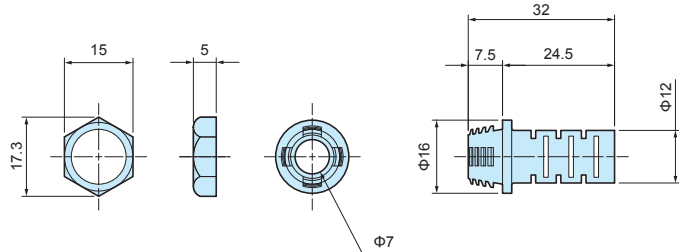

- Cord protector for protection against cord twists and breakage.
- Nut can be secured from the back side of the panel for additional stability.

Components

No.	Part name	Material
1	Connector	PVC
2	Nut	Polyethylene

Product no. / Feature

Product no.		Panel thickness	Cord diameter	Cord shape	Pack of
● Black	● Light Gray				
CP-127B	CP-127G	1.5 ~ 2.0	$\phi 5.8 \sim \phi 6.8$	Round cord	10

**CBF SERIES**

**CABLE HOOK**



APPLICATION EXAMPLE

- Used for wrapping and securing cords and wires.
- Can be used with a variety of different enclosure series and models.
- Requires a panel thickness of between 1.0 ~ 3.0mm.

**Product no. / Dimensions**

Product no.		Material	Pack of
● Gray	● Black		
CBF-1G	CBF-1B	POM	4

■ Included screws: M3-8 trivalent chromate (with washer) x 4 pcs

