

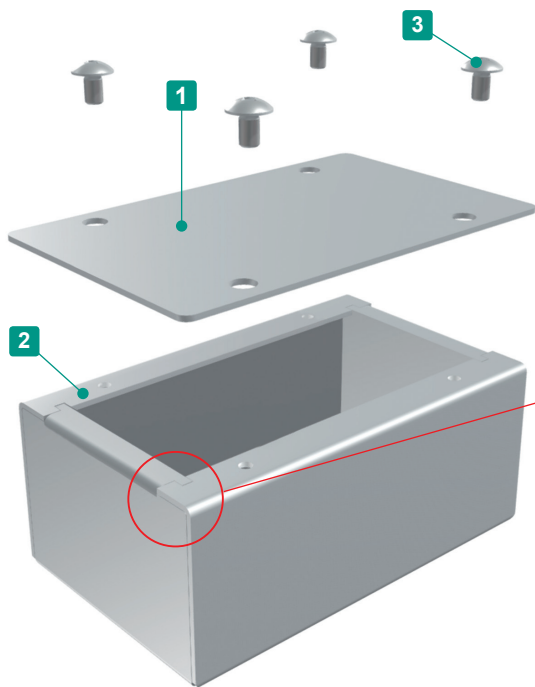

SIMPLE ALUMINIUM SHEET METAL BOX with COVER

Low-cost lineup of chassis cases released!

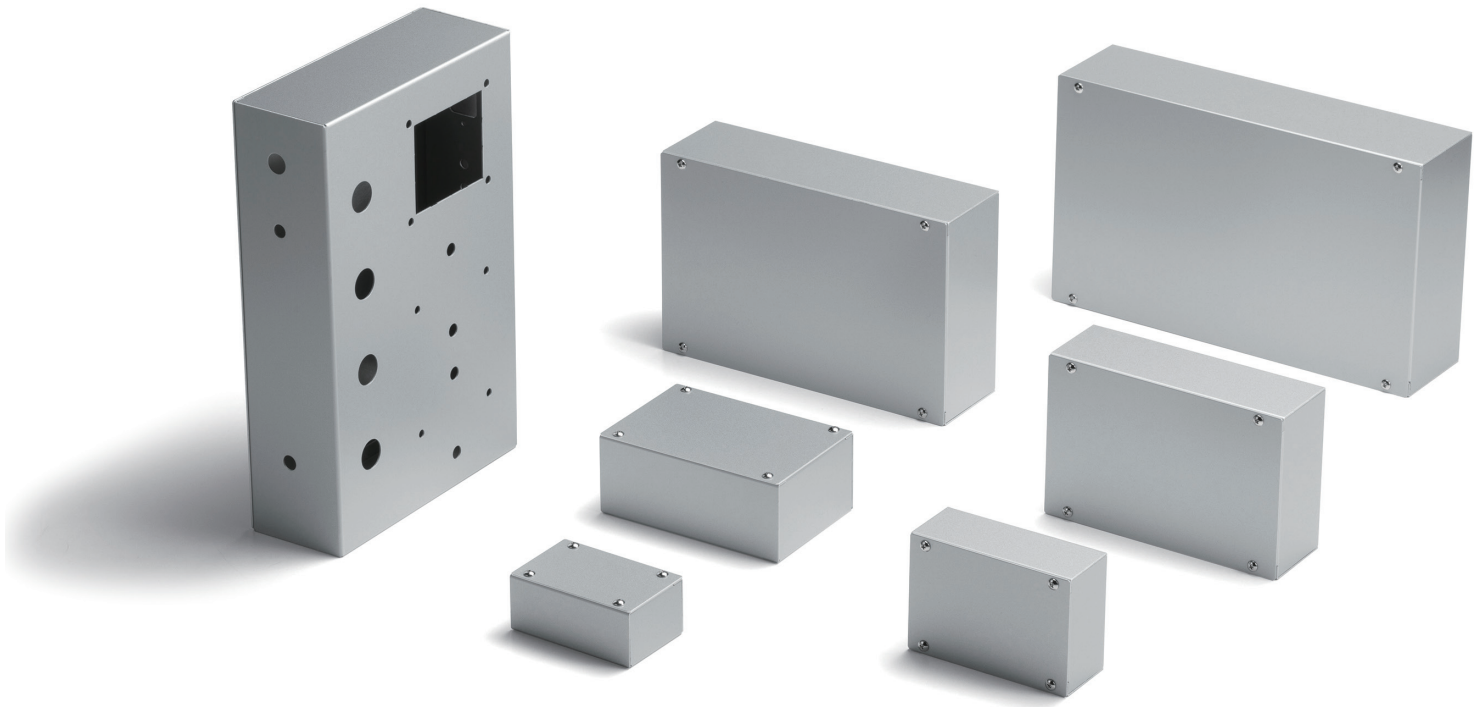



- Simple aluminium sheet metal box with an aluminium sheet cover.
- Internal surface of the sheet aluminium is unfinished, making conductive and grounding possible.
- Detachable top cover allows easy assembly and maintenance access.
- 6 different sizes are available.

■ Unique jointing techniques allows for sufficient strength without the need for welding.

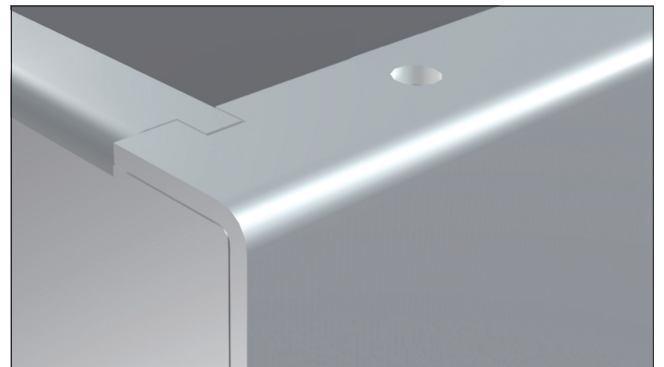

Components

No.	Part name	Pcs	Material	Color / Finish
1	Cover	1	Aluminium A1100P t = 1.0	Metallic silver / Painted: Unfinished internal surface
2	Base	1	Aluminium A1100P t = 1.0	Metallic silver / Painted: Unfinished internal surface
3	Screw (M3-5 truss)	4	Brass	Nickel plated

T dimensions

■ Drawings below are reference examples only.
DXF/DWG/PDF drawings available on our website.

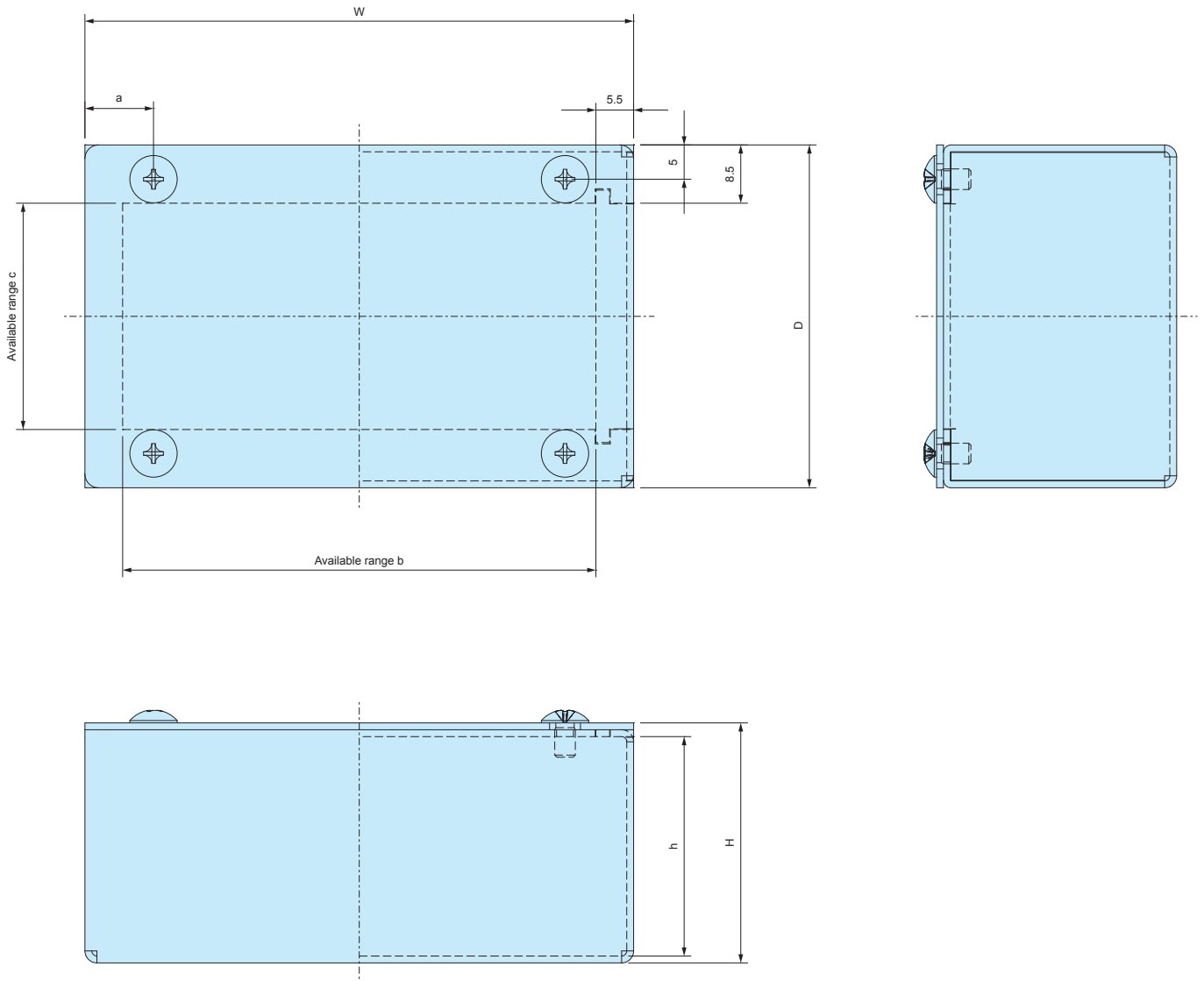

Product no. / Dimensions

Product no.	W	H	D	a	b	c	h	Weight (g)
T 8- 4- 5	80	35	50	10	69	33	32	49.5
T10- 4- 7	100	40	70	10	89	53	37	78
T12- 5- 8	120	50	80	10	109	63	47	110
T15- 5-10	150	50	100	15	139	83	47	153
T20- 6-13	200	60	130	15	189	113	57	252.5
T25- 6-15	250	60	150	15	239	133	57	339

Accessories (Optional parts)



Rubber feet B series
See page Feet-1 ~ Feet-4



Insert nut adhesive standoff AST series
See page AST-1



- Double -sided adhesive tape allows the standoff to be mounted quickly and easily; allows PCB mounting in non-boss enclosures.
- Convenient for installing PCBs into enclosures without the need for customization.
- Please ensure that surface is cleaned and grease-free before adhering.
- Once removed, it cannot be adhered on again.

AST2.5-□

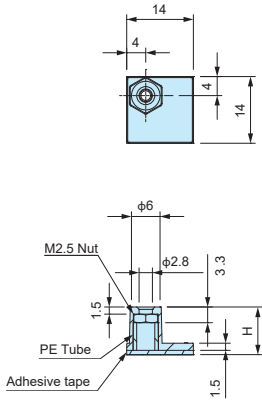

AST3-□

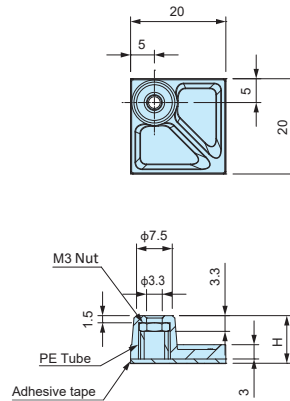

AST4-□

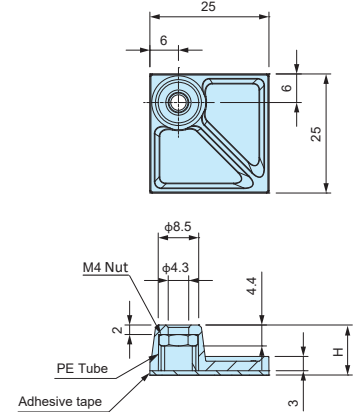

■ DXF/DWG/PDF drawings available on our website.

Product no. / Dimensions

■ Base material / color : Nylon 66 (UL94V-2) / Black
 ■ Nut • screw material / finish : Steel / Trivalent chromate

Product no.	H dimension	Included screw	Recommended PCB Thickness (mm)	Recommended torque (N • m)	Weight (g)	Pack of
AST2.5-5B	5	M2.5-5 panhead	1.0~2.0	0.3	0.6	4
AST2.5-10B	10	M2.5-5 panhead	1.0~2.0	0.3	0.8	4
AST3-6B	6	M3-6 panhead	1.0~3.0	0.4	1.5	4
AST3-10B	10	M3-6 panhead	1.0~3.0	0.4	1.6	4
AST3-15B	15	M3-6 panhead	1.0~3.0	0.4	1.8	4
AST3-20B	20	M3-6 panhead	1.0~3.0	0.4	2.1	4
AST4-10.5B	10.5	M4-8 panhead	1.0~3.5	0.8	2.6	4
AST4-20B	20	M4-8 panhead	1.0~3.5	0.8	3.2	4
AST2.5-5B-P	5	None	—	0.3	0.6	100
AST2.5-10B-P	10	None	—	0.3	0.8	100
AST3-6B-P	6	None	—	0.4	1.5	100
AST3-10B-P	10	None	—	0.4	1.6	100
AST3-15B-P	15	None	—	0.4	1.8	100
AST3-20B-P	20	None	—	0.4	2.1	100
AST4-10.5B-P	10.5	None	—	0.8	2.6	50
AST4-20B-P	20	None	—	0.8	3.2	50

TAKACHI ELECTRONICS ENCLOSURE CO., LTD.

3-21-16 Higashi-ryoke,
 Kawaguchi, Saitama 332-0003, JAPAN
 Tel. +81-48-222-5409

www.takachi-enclosure.com
sales@takachi-el.co.jp

● All items listed in this catalogue are compliant with EU RoHS 10 standard.

NEW PRODUCT Vol.1 2020.7

B SERIES ADHESIVE RUBBER FEET



■ DXF/DWG/PDF drawings available on our website.

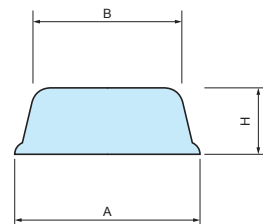

■ Injection molded type.

Product no. / Dimensions

■ Material : Synthetic rubber

Product no.	A	B	H	Color	Pack of
B 6-2	6	5	1.8	Black	10
B 8-4	8	7.7	3.5	Black	10
B10-4	10	9.2	4.2	Black	10
B11-3	10.8	10.2	3	Black	10
B11-5	11	9.6	5	Black	10
B12-4	12.7	10	3.8	Black	10
B15-5	15.4	14.8	5.1	Black	10
B16-7	16	13	7	Black	10
B19-4	19	15.8	4.2	Black	10
B21-7	21	17	7	Black	10
B23-5	22.8	22.4	5	Black	10
B26-11	26	20	11	Black	10
B 6-2G	6	5	1.8	Gray	10
B11-3G	10.8	10.2	3	Gray	10
B15-5G	15.4	14.8	5.1	Gray	10
B21-7G	21	17	7	Gray	10
B26-11G	26	20	11	Gray	10

B-P SERIES ADHESIVE RUBBER FEET

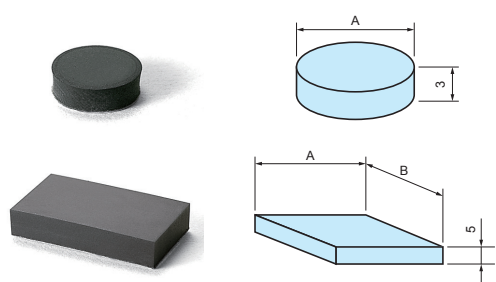

■ DXF/DWG/PDF drawings available on our website.

Product no. / Dimensions

■ Material / Color : Synthetic rubber / Black

Product no.	A	Pack of
B-P21	10	10
B-P22	20	10
B-P23	15	10

Product no. / Dimensions

■ Material / Color : Synthetic rubber / Black

Product no.	A	B	Pack of
B-P31	28	16	10
B-P32	46	26	10

■ Press-punched type.

TB SERIES ROUNDED ADHESIVE RUBBER FEET

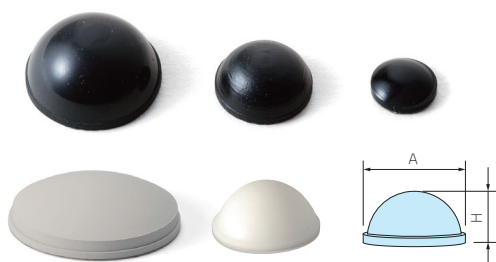

■ DXF/DWG/PDF drawings available on our website.

Product no. / Dimensions

■ Material : Synthetic rubber

Product no.	Product no.		A	H	Pack of
	● Black	● White (W) ● White gray (G)			
TB- 7	-	-	6.7	4.2	10
TB- 8	NEW TB- 8W	-	8	2.6	10
TB-10	-	-	10	2.8	10
TB-12	NEW TB-12W	-	11.3	5.6	10
TB-14	-	-	14	8	10
TB-16	NEW TB-16W	-	15.9	8	10
TB-21	-	-	21.6	8.5	10
TB-27	TB-27G	-	27.8	7.4	10

SF SERIES

SQUARE ADHESIVE RUBBER FEET - LOW COST TYPE

■ DXF/DWG/PDF drawings available on our website.

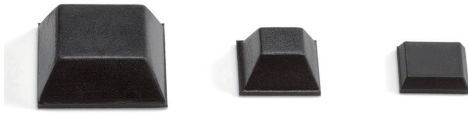

■ Square-shaped adhesive rubber feet.

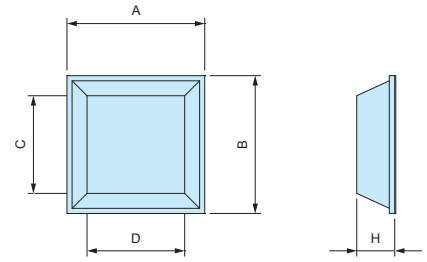

Product no. / Dimensions

■ Material / Color : Synthetic rubber / Black

Product no.	A	B	H	C	D	Pack of
SF11-3	10.5	10.5	2.5	8.6	8.6	10
SF13-4	12.7	12.7	3.5	9	9	10
SF13-6	12.7	12.7	6	7	7	10
SF20-8	20	20	7.6	14	14	10

SJ-P SERIES

SQUARE ADHESIVE POLYURETHANE FEET

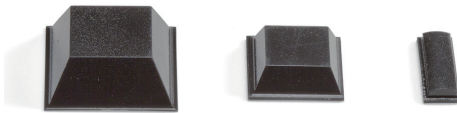

- Strong adhesive strength with the use of rubber pressure sensitive adhesive.
- Polyurethane material is resistant against color migration.

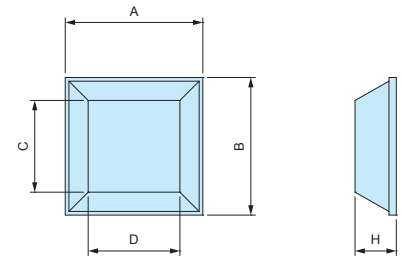

Product no. / Dimensions

■ Material / Color : Polyurethane / Black

Product no.	A	B	H	C	D	Pack of
SJ-P5007	10.4	10.4	2.5	7.5	7.5	10
SJ-P5008	12.7	12.7	3	9.5	9.5	10
SJ-P5018	12.7	12.7	5.8	7	7	10
SJ-P1004	15	15	4.5	10	10	10
SJ-P5023	20.6	20.6	7.6	12.7	12.7	10
SJ-P1011	15.5	5.5	2	4.5	14.5	10

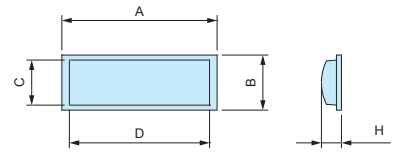

SJ-P1011

TN-27

OVAL ADHESIVE RUBBER FEET

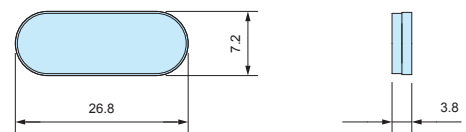
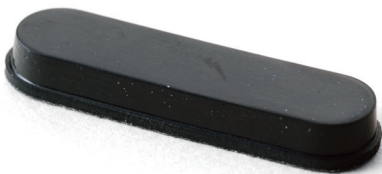

Product no. / Feature

■ Material / Color : Synthetic rubber / Black

Product no.	Pack of
TN-27	10

B-P SERIES SCREW MOUNT RUBBER FEET



DXF/DWG/PDF drawings available on our website.

- Built-in washer and non-washer types are available.
- Installation screws are separately sold.

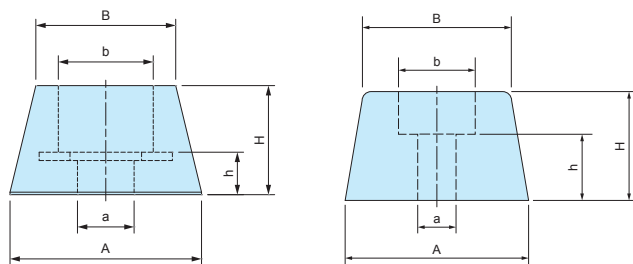

B-P1S, P1M, P1L, P2S, P4, P5

B-P1, P2, P3

Product no. / Dimensions

Color : Black

Product no.	A	B	H	a	b	h	Washer	Material	Pack of
B-P1S	11.5	8.4	7.2	3.4	5.7	3.2	○	Synthetic rubber	10
B-P1M	15	15	4	3.5	7.4	2.2	○	Synthetic rubber	10
B-P1	15	13	7.7	3	6	4.2	×	Synthetic rubber	10
B-P1L	16	13	7.8	3	6	3.7	○	Synthetic rubber	10
B-P2S	18	15	11	3	6	5	○	Synthetic rubber	10
B-P2	19	15	8	3	6	4.5	×	Synthetic rubber	10
B-P3	22	18	13	3	7.5	7	×	Synthetic rubber	10
B-P4	32	26	20	5	15	10	○	EPDM	10
B-P5	32	28	15	5	14	10	○	EPDM	10

B-P SERIES SNAP-IN RUBBER FEET



DXF/DWG/PDF drawings available on our website.

- Hole milling required for installation.

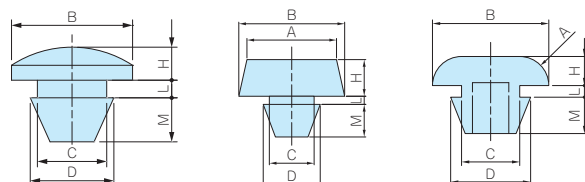

B-P10

B-P10S, P11, P12

B-P13, P14, P15

Product no. / Dimensions

Product no.	A	B	H	C	D	L	M	Material	Color	Pack of
B-P10S	8	8	2	5	5.6	0.9	3	Silicone UL94V-0	Black	10
B-P10	—	11	3	6.3	7.6	1.6	4	Silicone UL94V-0	Black	10
B-P11	11	13	4.5	5.5	7	1	4	Synthetic rubber	Black	10
B-P12	15	17	4.5	5.5	7	1	4	Synthetic rubber	Black	10
B-P13	R3	12	3	5	7	1.6	4	EPDM	Black	10
B-P14	R4	14	4	6	9	1.6	5	EPDM	Black	10
B-P15	R4	16	4	8	11	1.6	5	EPDM	Black	10

A-P SERIES

SCREW MOUNT ELASTOMER FEET

■ DXF/DWG/PDF drawings available on our website.

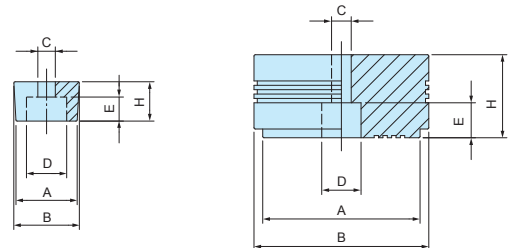

A-P1 ~ A-P5

A-P6

- Prepare screws for installation.
- Resistant against color migration.

Product no. / Dimensions

■ Material / Color : Elastomer / Black

Product no.	A	B	H	C	D	E	Pack of
A-P1	9.4	10.8	4	3.3	6.8	2	10
A-P2	13.4	14.2	5.5	3	8	3.5	10
A-P3	14	15	9	4	9.5	6	10
A-P4	20	21	8	4	8.2	5	10
A-P5	20	24	14	5.5	8.6	8	10
A-P6	36	40	19	4.5	9	7.5	10

TP SERIES

SNAP-IN ELASTOMER FEET

■ DXF/DWG/PDF drawings available on our website.

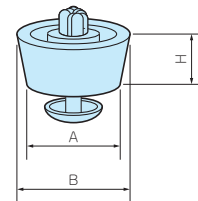

- Easy installation with snap-in pin.
- Require a hole for installation.
- Resistant against color migration.

Product no. / Dimensions

■ Material / Color : (Feet) LDPE • (PIN) PP / Black

Product no.	A	B	H	Mounting hole	Panel thickness	Pack of
TP-1	12	12.7	4.4	5	1.0 ~ 2.0	10
TP-2	15	15.7	4.4	5	1.0 ~ 2.0	10
TP-3	17.2	19.2	7.9	8	0.8 ~ 1.2	10
TP-4	18	20	10	8	1.0 ~ 2.5	10
TP-5	19.8	20.8	6.4	8	1.0 ~ 2.5	10
TP-6	19.5	23.7	13.7	8	1.0 ~ 2.5	10
TP-7	26.5	29.4	15	10	1.0 ~ 3.5	10

TM SERIES

PLASTIC FEET

■ DXF/DWG/PDF drawings available on our website.

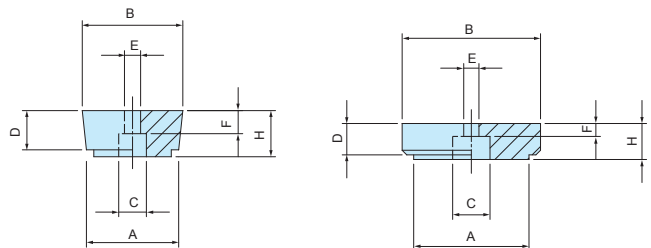

TM-1, TM-2

TM-1S, TM-3

- Plastic feet equipped with soft padding on the bottom to prevent sliding.

Product no. / Dimensions

Product no.	A	B	H	C	D	E	F	Feet material	Pad material	Color	Pack of
TM-1S	15.9	19.5	6.3	7	5.8	4	2.3	ABS UL94HB	Silicone	Black	10
TM-1	20	21.8	10	7.2	8.5	3.5	4.5	ABS UL94HB	EVA	Black	10
TM-2	20	21.8	15	7.2	13.5	3.5	4.5	ABS UL94HB	EVA	Black	10
TM-3	25	30	7.8	8.1	6.8	3.3	2.7	ABS UL94HB	EVA	Black	10

MR SERIES

SLOTTED RAISED COUNTERSUNK TORX SCREW



- For use with top / bottom cover.
- Recommended for aesthetic purposes, or for tampering resistance.
- Requires the use of a specialized screwdriver.

Product no. / Dimensions

Product no.	M	L	TORX head no.	Material	Color / Finish	Pack of
MR3-5ZS	3	5	T10	Steel	Nickel plated	20
MR3-5ZB	3	5	T10	Steel	Black trivalent chromate	20

FDR SERIES

DIN-RAIL

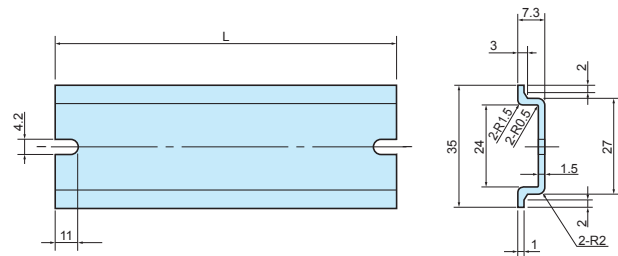
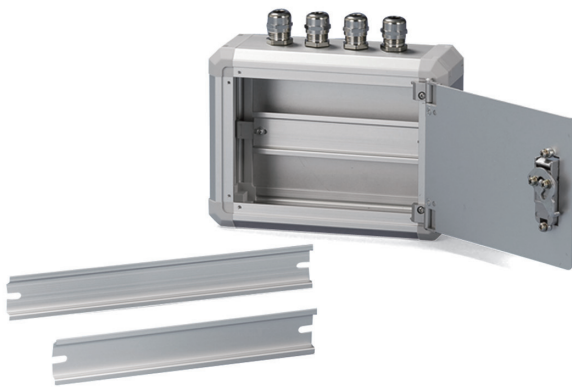

Components

Material	Color / Finish
Aluminium A6063S-T5	Silver / Anodized

Product no. / Dimensions

Product no.	L	Box length
FDR- 50	50	100
FDR-100	100	150
FDR-150	150	200
FDR-205	205	250
FDR-249	249	300
FDR-300	300	350
FDR-350	350	400
FDR-450	450	500
FDR-550	550	600

- FCK mounting bracket is required for installation.
- Not suitable for FC4 (H = 37.9mm).

EV3-5S

CONDUCTIVE SCREW



Conductive

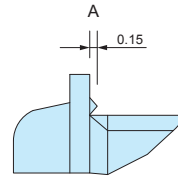
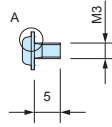
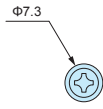

- When tightened, protrusions on the underside of the screw head will shave away at painted or anodized surface to expose the base material for achieving conductivity.

Product no. / Dimensions

Product no.	M	L	Material	Finish	Pack of
EV3-5S	3	5	Steel	Nickel plated	20