

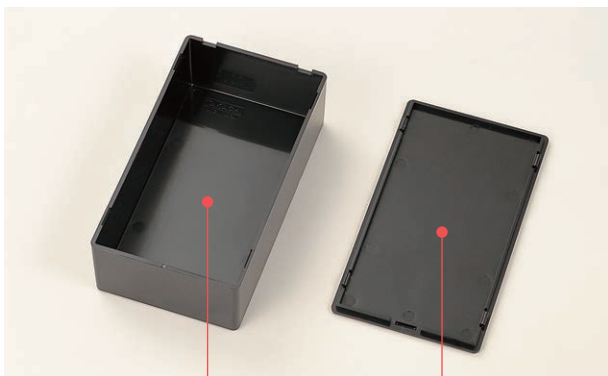

Technical Data
Protection class: IP40
Operating temperature:
SW-SW-N: -10°C ~ +60°C
SW-T: -10°C ~ +100°C



1

2

- No screws required; simple snap on / off cover.
- General purpose compact type case.
- Ample interior space.
- Exclusive PCB is available.
- 3 different material types (standard, flame-resistant, and heat-resistant) are available.

Components

No.	Part name	Material / Color
1	Base	SW : ABS UL94HB / Light gray • Black
		SW-N : ABS UL94V-1 : UL94V-0 / Gray
		SW-T : ABS flame-resistant / Black
2	Cover	SW : ABS UL94HB / Light gray • Black
		SW-N : ABS UL94V-1 : UL94V-0 / Gray
		SW-T : ABS flame-resistant / Black

Accessories (Optional parts)



Adhesive standoff T-600, 700, ASR
See page Standoff-1



Neodymium magnet NMG series
See page NMG-1

SW-SW-N-SW-T dimensions

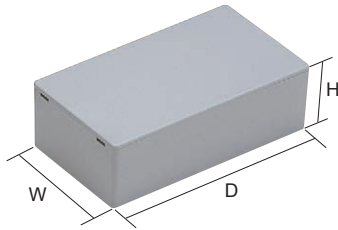

■ Drawings below are reference examples only.
DXF/DWG/PDF drawings available on our website.

Color Type

Series	Code	Color
SW	S	Light gray
	B	Black
SW-N	G	Gray
SW-T	B	Black

SW standard (ABS UL94HB)

Product no. / Dimensions

Product no.		Dimensions			Weight (g)
● Light gray	● Black	W	H	D	
SW- 15S	SW- 15B	10	10	15	1
SW- 20S	SW- 20B	15	15	20	2
SW- 30S	SW- 30B	20	18	30	4
SW- 40S	SW- 40B	30	20	40	10
SW- 50S	SW- 50B	35	25	50	14
SW- 53S	SW- 53B	36	11	53	10
SW- 55S	SW- 55B	40	20	55	17
SW- 60S	SW- 60B	18	17	60	9
SW- 65S	SW- 65B	45	25	65	21
SW- 75S	SW- 75B	50	30	75	32
SW- 85S	SW- 85B	60	40	85	43
SW- 90S	SW- 90B	25	21	90	17
SW- 95S	SW- 95B	58	18	95	34
SW-100S	SW-100B	65	35	100	55
SW-120S	SW-120B	60	24	120	50
SW-125S	SW-125B	70	40	125	77
SW-130S	SW-130B	40	25	130	43

SW-N flame-resistant (ABS UL94V-1 : UL94V-0)

Product no. / Dimensions

Product no.	W	H	D	UL class	Weight (g)
SW-N 20G	15	15	20	UL94V-1	3
SW-N 30G	20	18	30	UL94V-1	5
SW-N 40G	30	20	40	UL94V-0	11
SW-N 50C	35	25	50	UL94V-0	17
SW-N 55G	40	20	55	UL94V-0	19
SW-N 65G	45	25	65	UL94V-0	23
SW-N 75G	50	30	75	UL94V-0	35
SW-N 85G	60	40	85	UL94V-0	50
SW-N 95G	58	18	95	UL94V-0	37
SW-N100C	65	35	100	UL94V-0	60
SW-N120G	60	24	120	UL94V-0	56
SW-N125C	70	40	125	UL94V-0	95
SW-N130G	40	25	130	UL94V-0	48

Cross out products are discontinued.

SW-T heat-resistant (ABS heat distortion temperature 100°C)

Product no. / Dimensions

Product no.	W	H	D	Weight (g)
SW-T 20B	15	15	20	2
SW-T 40B	30	20	40	9
SW-T 55B	40	20	55	16
SW-T 75B	50	30	75	30
SW-T 95B	58	18	95	31
SW-T100B	65	35	100	50

T-600

M3 INSERT NUT ADHESIVE STANDOFF

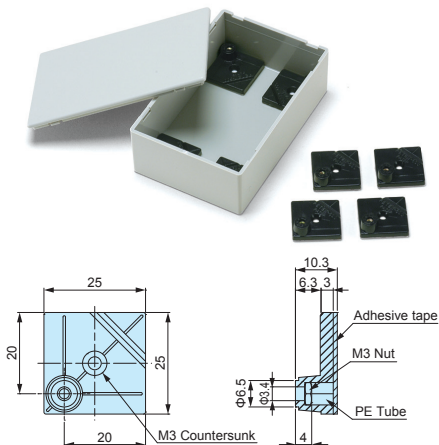

- Double-sided adhesive tape allows the standoff to be mounted easily; allows PCB mounting in non-boss enclosures.

NOTE

- Please ensure the surface is cleaned and grease-free before adhering.
- Once removed, it cannot be adhered on again.
- Recommended screw torque: 4kgf • cm (0.4N • m).

Product no. / Dimensions

Product no.	Material	Color	Weight (g)	Pack of
T-600	ABS	Black	2.6 (g) / pc	10

T-700

M4 INSERT NUT ADHESIVE STANDOFF

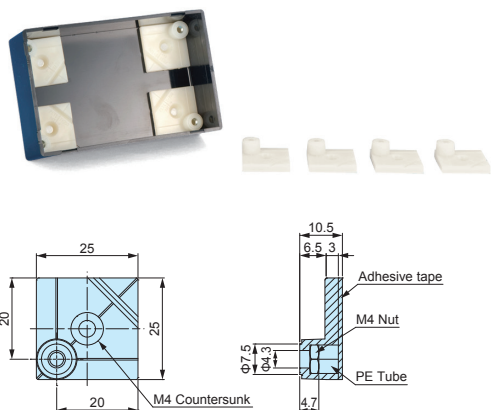

- Double-sided adhesive tape allows the standoff to be mounted easily; allows PCB mounting in non-boss enclosures.

NOTE

- Please ensure the surface is cleaned and grease-free before adhering.
- Once removed, it cannot be adhered on again.
- Recommended screw torque: 8.1kgf • cm (0.81N • m).

Product no. / Dimensions

Product no.	Material	Color	Weight (g)	Pack of
T-700	ABS	Natural	2.6 (g) / pc	10

ASR SERIES

ADHESIVE STANDOFF

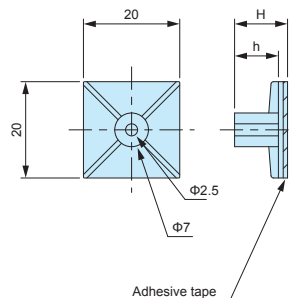

- M3 tapping screw use adhesive standoff.
Recommended to be used with EM-3 or EM-3-6 tapping screws (See page 115).

NOTE

- Please ensure the surface is cleaned and grease-free before adhering.
- Once removed, it cannot be adhered on again.
- Recommended screw torque: 4kgf • cm (0.4N • m).

Product no. / Dimensions

Product no.	H	h	Weight (g)	Pack of
ASR- 5	5.1	3.1	0.9 (g) / pc	10
ASR- 6	6.4	4.4	1.0 (g) / pc	10
ASR- 7	7.2	5.1	0.9 (g) / pc	10
ASR- 8	8.1	6.3	0.9 (g) / pc	10
ASR- 9	9	7	1.0 (g) / pc	10
ASR-11	11	9	1.0 (g) / pc	10
ASR-13	12.7	10.7	1.2 (g) / pc	10
ASR-14.5	14.7	12.8	1.1 (g) / pc	10
ASR-16	15.9	13.9	1.3 (g) / pc	10
ASR-19	19.1	17.1	1.4 (g) / pc	10

■ Material: Nylon 66 UL94V-2

NMG SERIES

NEODYMIUM MAGNET



Round magnet



- Material / Finish: Neodymium / Nickel plated
- Please attach using a strong adhesive.

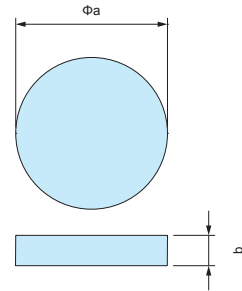

Components

Product no.	a	b	Weight (g)	Flus Density	Adsorption
NMG3-15N	15	3	4	214.4 mT	2.44 kgf
NMG3-20N	20	3	7.1	170.7 mT	3.26 kgf
NMG5-22N	22	5	11.4	247.2 mT	5.91 kgf
NMG5-25N	25	5	18.4	221.9 mT	6.89 kgf

Round magnet with countersunk hole



- Please fasten with a screw.

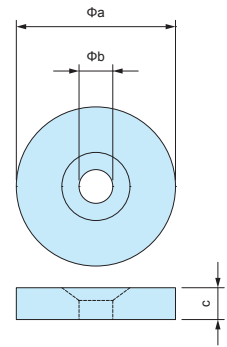

Components

Product no.	a	b	c	Countersunk size	Weight (g)	Flus Density	Adsorption
NMG3-15M3	15	3.2	3	M3	3.8	214.3 mT	2.33 kgf
NMG3-20M3	20	3.2	3	M3	6.9	170.6 mT	3.17 kgf
NMG5-22M4	22	4.3	5	M4	13.7	247.2 mT	5.68 kgf
NMG5-25M5	25	5.3	5	M5	17.6	221.9 mT	6.58 kgf

Rectangular magnet with countersunk holes



- Please fasten with a screw.

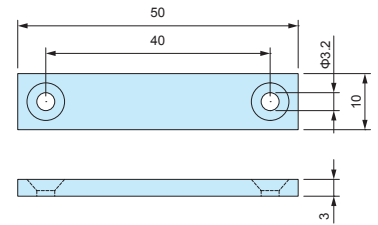

Components

Product no.	a	b	c	Countersunk size	Weight (g)	Flus Density	Adsorption
NMG3-50M3	50	10	3	M3	11.3	210.0 mT	9.1 kgf

Example 1 The magnetic force remains strong even through plastic.

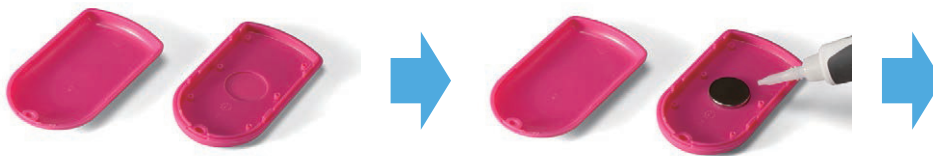

Make recessed pocket on the inside wall.

Glue on.



Attach onto a metallic surface.

Example 2

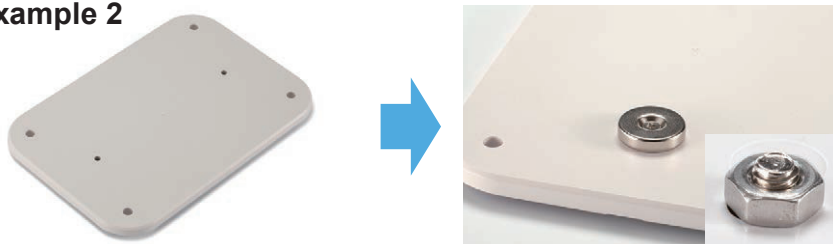

Make holes

Fasten with a screw and nut.



Attach onto a metallic surface.

CAUTION: Handle with care to avoid personal injury or damage to the magnet.

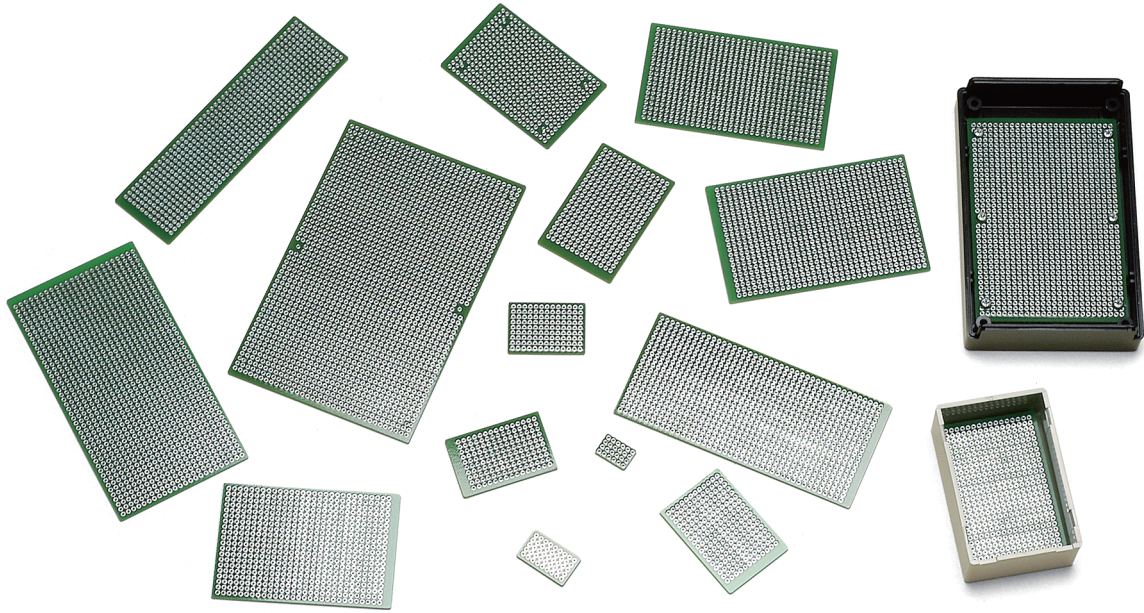

- Material / Finish : Glass epoxy (FR-4) / Through-hole - Lead-free solder resist
- Environmentally friendly lead-free solder.
- 25 different sizes available. See chart on page TNF-2 for suitable cases/boxes.
- TNF160-240 is for multi-size use. Cut it to fit your needs when using.

Accessories (Optional parts)

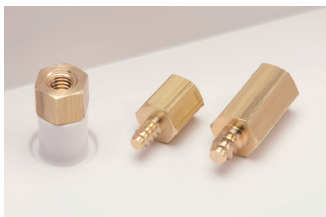

Tapping standoff TPS series
See page TPS • MT-1



Adhesive standoff T-600, 700 series
See page Standoff-1



Adhesive standoff ASR series
See page Standoff-1



PCB mounting screw EM series
See page EM • MR-1

Pattern A

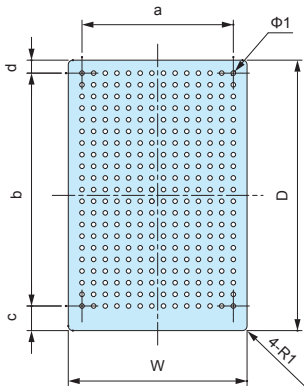

Pattern B

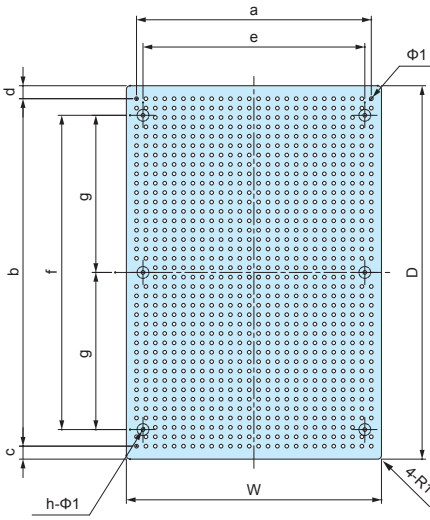

Pattern C

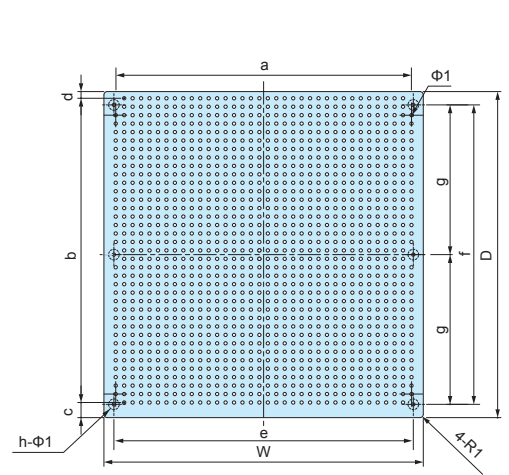

Pattern D

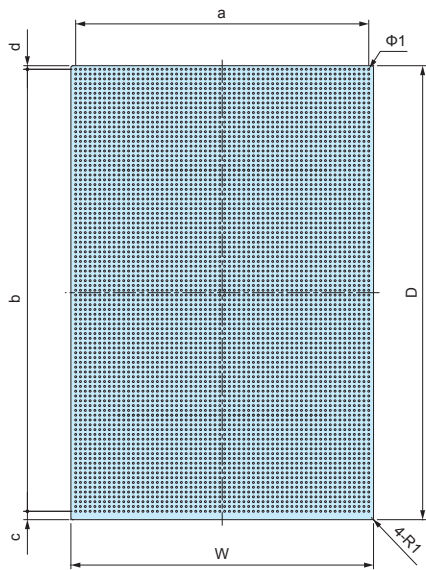

Pattern E

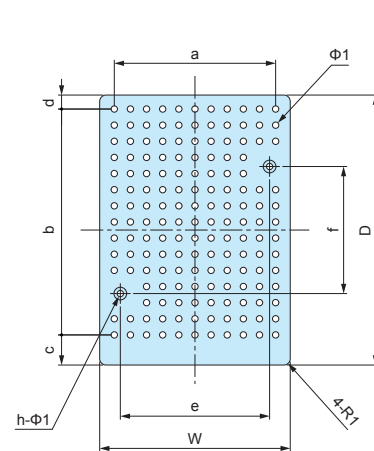

Product no. / Dimensions

■ Pattern B, C, and E PCBs come with holes for boss mounting.

Product no.	W	D	a	b	c	d	e	f	g	h	Holes	Pattern	Suitable case
TNF 11- 16	10.7	15.8	7.62	12.7	1.55	1.55	—	—	—	—	4 x 6	A	SW-20
TNF 15- 25	15	25	10.16	20.32	2.34	2.34	—	—	—	—	5 x 9	A	SW-30
TNF 25- 35	25	35	20.32	30.48	2.26	2.26	—	—	—	—	9 x 13	A	SW-40
TNF 29- 32	29.5	32.5	25.4	25.4	4.82	2.28	23.5	20	—	2	11 x 11 ■	E	TW • TWN4-2-5
TNF 29- 42	29.5	42.5	25.4	35.56	4.74	2.2	23.5	20	—	2	11 x 15 ■	E	TW • TWN4-2-6
TNF 29- 44	29	44	22.86	35.56	5.49	2.95	—	—	—	—	10 x 15	A	SW-50 • 53
TNF 34- 49	34	49	27.94	40.64	5.45	2.91	—	—	—	—	12 x 17	A	SW-55
TNF 34- 62	34.5	62.5	30.48	55.88	4.58	2.04	28.5	40	—	2	13 x 23 ■	E	TW • TWN4-2-8
TNF 34-124	34	124	27.94	116.84	4.85	2.31	—	—	—	—	12 x 47	A	SW-130
TNF 39- 59	39	59	33.02	50.8	5.37	2.83	—	—	—	—	14 x 21	A	
TNF 39- 70	39.5	70	33.02	60.96	5.79	3.25	27.94	58.42	—	4	14 x 25	A	TW • TWN5-3-9
TNF 43- 66	43	66	38.1	58.42	3.79	3.79	30	50	—	4	16 x 24 ■	B	
TNF 43- 79	43.5	79.5	38.1	73.66	2.92	2.92	—	—	—	—	16 x 30	A	TW5-3-10
TNF 44- 69	44	69	38.1	60.96	5.29	2.75	—	—	—	—	16 x 25	A	SW-75
TNF 52- 89	52	89	45.72	81.28	3.86	3.86	—	—	—	—	19 x 33	A	SW-95
TNF 53- 79	53	79	48.26	71.12	5.21	2.67	—	—	—	—	20 x 29	A	SW-85 • TW • TWN7-□-11
TNF 53-114	53	114	48.26	106.68	4.93	2.39	—	—	—	—	20 x 43	A	SW-120
TNF 59- 94	59	94	53.34	86.36	5.09	2.55	—	—	—	—	22 x 35	A	SW-100
TNF 63-119	63	119	58.42	111.76	4.89	2.35	—	—	—	—	24 x 45	A	SW-125
TNF 69-101	69	101	63.5	93.98	3.51	3.51	60	—	42.5	6	26 x 38 ■	B	
TNF 89-136	89	136	83.82	129.54	3.23	3.23	80	—	60	6	34 x 52 ■	B	
TNF 96- 98	96	98	88.9	91.44	4.55	2.01	90	90	45	6	36 x 37 ■	C	
TNF122- 99	122	99	116.84	91.44	3.78	3.78	—	—	—	—	47 x 37	A	
TNF128-136	136	128	129.54	121.92	4.31	1.77	130	120	60	6	52 x 50 ■	C	
TNF160-240	160	240	154.94	233.68	3.93	2.39	—	—	—	—	62 x 93	D	

TPS SERIES

TAPPING STANDOFF



- Tapping screw head allows for easy installation onto existing enclosure boss mount.
- 3 different sizes available : M2.3, M2.6 and M3 size.

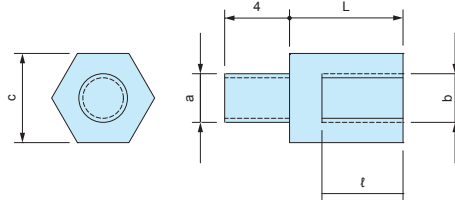

Product no. / Dimensions

■ Material / Finish : Brass / Unfinished

Product no.	Screw size (a)	Screw size (b)	c	L	ℓ	Pack of	Recommended enclosure models	
TPS-M2.3-4	M2.3	M2.3	5	4	3	4	WH series • PFE series LC • LCE • LCS • LCT series PF • PFF series (M2.3 boss models) TW • TWN • TWF series (M2.3 boss models) WP series (M2.3 boss models)	
TPS-M2.3-5	M2.3	M2.3	5	5	3	4		
TPS-M2.3-6	M2.3	M2.3	5	6	4	4		
TPS-M2.3-7	M2.3	M2.3	5	7	5	4		
TPS-M2.3-8	M2.3	M2.3	5	8	6	4		
TPS-M2.3-10	M2.3	M2.3	5	10	6	4		
TPS-M2.3-12	M2.3	M2.3	5	12	6	4		
TPS-M2.6-4	M2.6	M2.6	5	4	3	4		PF • PFF series (M2.6 boss models) WP series (M2.6 boss models)
TPS-M2.6-5	M2.6	M2.6	5	5	3	4		
TPS-M2.6-7	M2.6	M2.6	5	7	5	4		
TPS-M2.6-10	M2.6	M2.6	5	10	6	4		
TPS-M2.6-12	M2.6	M2.6	5	12	6	4	SU • OP series TWS • TW • TWN • TWF series (M3 boss models)	
TPS-M3-4	M3	M3	5.5	4	3	4		
TPS-M3-5	M3	M3	5.5	5	3	4		
TPS-M3-6	M3	M3	5.5	6	4	4		
TPS-M3-7	M3	M3	5.5	7	5	4		
TPS-M3-8	M3	M3	5.5	8	5	4		
TPS-M3-10	M3	M3	5.5	10	6	4		
TPS-M3-12	M3	M3	5.5	12	6	4		



- Please use a suitable sized socket driver to both secure and loosen the tapping standoff.



MT SERIES

PCB MOUNTING SCREWS for TPS



- PCB mounting Screws for TPS tapping standoffs.

Product no. / Dimensions

Product no.	M	L	Head style	Material	Finish	Pack of
NEW MT2.3-4	2.3	4	Pan	Steel	Trivalent chromate	20
NEW MT2.3-6	2.3	6		Steel	Trivalent chromate	20
NEW MT2.6-4	2.6	4		Steel	Trivalent chromate	20
MT3-4	3	4		Steel	Trivalent chromate	20

EM SERIES

PCB MOUNTING SCREW

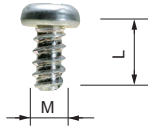

- Self-tapping screws for mounting PCB on bosses or standoffs.
- EM-3-6 self-tapping screws are suitable for mounting 1.6mm or thicker PCB.

Product no. / Dimensions

Product no.	M	L	Material	Finish	Suitable enclosures	Pack of
EM-1.6	1.6	4	Steel	Trivalent chromate	WC • CSS • CS • PS (M1.6 size)	50
EM-2	2	5	Steel	Trivalent chromate	PS • TW • TWN • TWF • WP (M2 size)	50
EM-2.3	2.3	6	Steel	Trivalent chromate	WH • LC • LCT • LCS • LCE • PFE WSC (Top cover bosses) PF • PFF (M2.3 size) TW • TWN • TWF (M2.3 size) WP (M2.3 size)	50
NEW EM-2.3-8	2.3	8	Steel	Trivalent chromate	WSC (Bottom base bosses)	50
EM-2.6	2.6	6	Steel	Trivalent chromate	PF • PFF • WP (M2.6 size)	50
EM-3	3	5	Steel	Trivalent chromate	SU TWS • TW • TWN • TWF (M3 sizes)	50
EM-3-6	3	6	Steel	Trivalent chromate		50

MR SERIES

TORX SCREW



Countersunk head

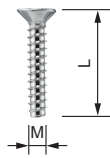

Pan head

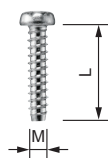

With pin

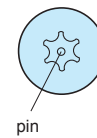

★ Without pin

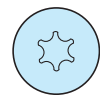

★ : MR1.6-6S, MR-2S, MR2.6-10□, and MR3-14□ are without pin.

Product no. / Dimensions

★Mark = Without pin

Product no.	M	L	head no.	Head style	Material	Finish	Suitable enclosures	Pack of
MR1.6-6S★	1.6	6	T3	Pan	Steel	Nickel plated	CS • CSS	20
MR2.5-8PS	2.5	8	T8	Pan	Steel	Nickel plated	PF • PFE • PFF (M2.5 size)	20
MR2.6-10S★	2.6	10	T8	Countersunk	Steel	Nickel plated	TW • TWN (M2.6 models) TWF (M2.6 models)	20
MR2.6-10B★	2.6	10	T8	Countersunk	Steel	Black trivalent chromate	MX • MXA • MXB • MXF (M2.6 models)	20
MR2.6-12PS	2.6	12	T8	Pan	Steel	Nickel plated	LCT • LCS • LC115-F2 / F3 LCT • LCS • LC145S-F6	20
MR2.6-14PS	2.6	14	T8	Pan	Steel	Nickel plated	LCT • LCS • LC115H-F2 / F3 / M2 / 9V LCT • LCS • LC135-F4 / M2 / M3 / 9V LCT • LCS • LC135H-F4 / M2 / M3 / 9V LCT • LCS • LC145-F6 / M2 / M4 LCT • LCS • LC145H-F6 / M2 / M4 LCT • LCS • LC165-M4 LCT • LCS • LC165H-M4	20
MR2.6-14S	2.6	14	T8	Countersunk	Steel	Nickel plated	LCT • LCS • LC115-N / F2 / F3 LCT • LCS • LC145S-F6 / 145S-N LCE115-N TW • TWN7-2-11 / 7-4-11 / 7-5-11 TWF7-2-11 / 7-4-11 / 7-5-11 / 8-2-8 / 8-4-8	20
MR2.6-18S	2.6	18	T8	Countersunk	Steel	Nickel plated	LCT • LCS • LC115H-N / F2 / F3 / M2 / 9V LCT • LCS • LC135-N / F4 / M2 / M3 / 9V LCT • LCS • LC135H-N / F4 / M2 / M3 / 9V LCT • LCS • LC145-N / F6 / M2 / M4 LCT • LCS • LC145H-N / F6 / M2 / M4 LCT • LCS • LC165-N / M4 LCT • LCS • LC165H-N / M4 LCE115H-N • LCE135-N • LCE145H-N • LCE165H-N	20
MR3-8PS	3	8	T10	Pan	Steel	Nickel plated	PF • PFE • PFF (M3 size)	20
MR3-14S★	3	14	T10	Countersunk	Steel	Nickel plated	TW • TWN (M3 models) TWF (M3 models)	20
MR3-14B★	3	14	T10	Countersunk	Steel	Black trivalent chromate	MX • MXA • MXB • MXF (M3 models)	20
MR-2S★	3	10	T10	Countersunk	Steel	Nickel plated	HEN	20