

SSM SERIES

IP65 STAINLESS STEEL BOX - LATCH-HINGED TYPE



Technical Data
Protection class: IP65
Operating temperature: -40°C ~ +90°C

- IP65 enclosure with easy open/close key latch/hinge.
- Made of stainless steel (SUS304) for superior weather and corrosion resistance.
- Conductive box for EMC shielding.
- Polished finish.
- Key latch for tamper-proof purposes.

Components

No.	Part name	Pcs	Material	Color / Finish
1	Cover	1	Stainless steel SUS304 t = 1.2	Polished finish
2	Body	1	Stainless steel SUS304 t = 1.2	Polished finish
3	Hinge	2	Stainless steel SUS304 t = 1.2	Barrel finish
4	Gasket	1	EPDM	Black
5	Latch (with key)	2	Stainless steel SUS304 t = 1.2	Barrel finish
6	Z-Mounting bracket	2	Stainless steel SUS304 t = 1.5	Unfinished
7	Key	2	Steel SPCC	Nickel plated

Accessories (Optional parts)

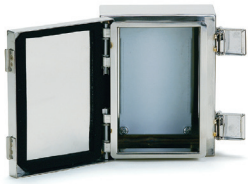

Mounting plate SSC series
See page SSC • FDR-1



Cable gland
See cable gland pages



Pole mounting belt PKB series
See page PKB-1

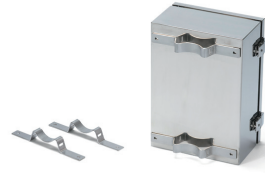

Pole mounting bracket SSK series
See page SSK-M-1 ~ SSK-M-3

SSM dimensions

■ Drawings below are reference examples only.
DXF/DWG/PDF drawings available on our website.

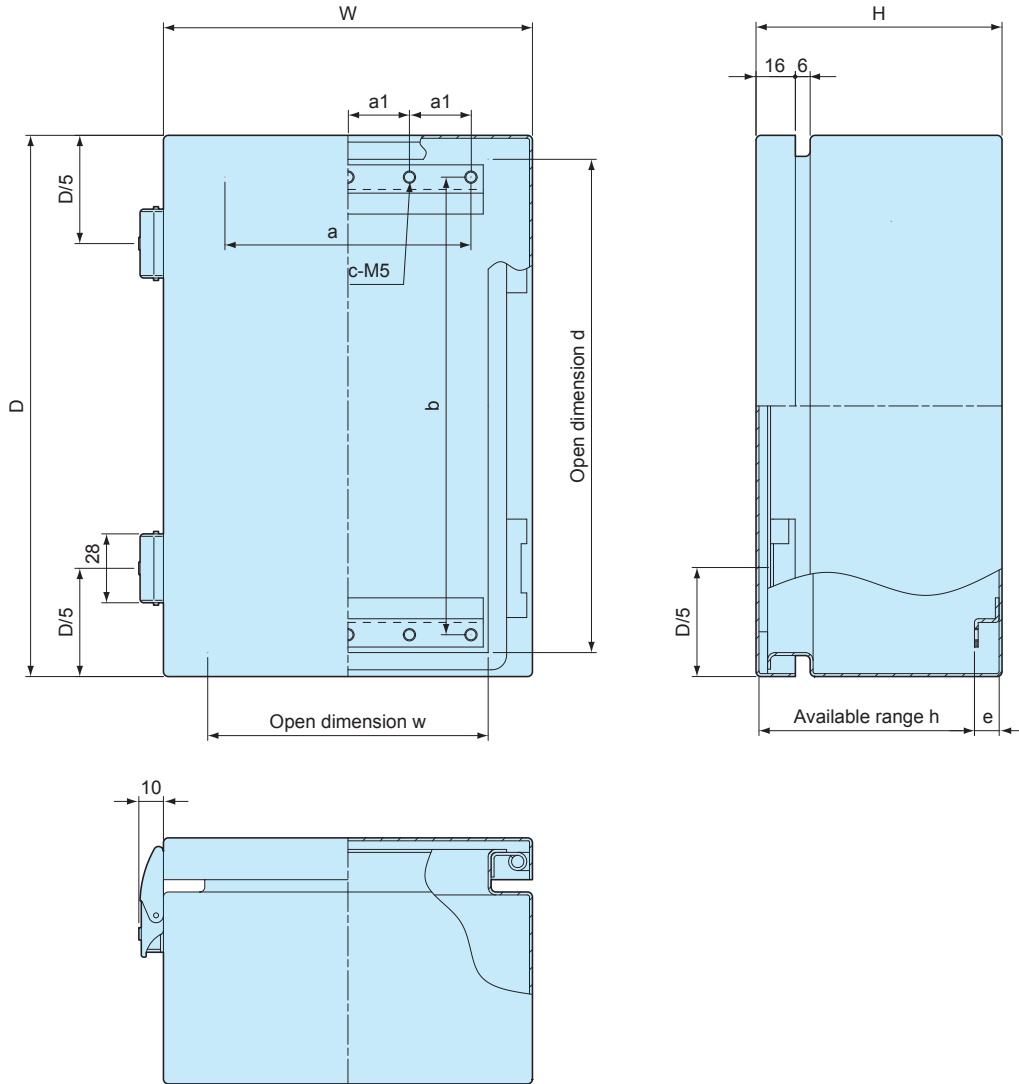

Product no. / Dimensions

Product no.	W	D	H	w	d	h	a	a1	b	c	e	Weight (kg)
SSM121508	120	150	80.5	84	130.5	68.1	66	33	116	6	10	1.0
SSM151508	150	150	80.5	114	130.5	68.1	96	24	116	10	10	1.2
SSM152206	150	220	60.5	114	200.5	51.6	96	24	186	10	6.5	1.4
SSM152210	150	220	100.5	114	200.5	88.1	96	24	186	10	10	1.7
SSM202010	200	200	100.5	164	180.5	88.1	146	36.5	166	10	10	1.9
SSM202806	200	280	60.5	164	260.5	51.6	146	36.5	246	10	6.5	2.0
SSM202812	200	280	120.5	164	260.5	108.1	146	36.5	246	10	10	2.6
SSM223312	220	330	120.5	184	310.5	108.1	166	41.5	296	10	10	3.0
SSM304015	300	400	150.5	264	380.5	138.1	246	61.5	366	10	10	4.8

SSC SERIES

MOUNTING PLATE for SSM • SLM • SSB • SLB

■ DXF/DWG/PDF drawings available on our website.

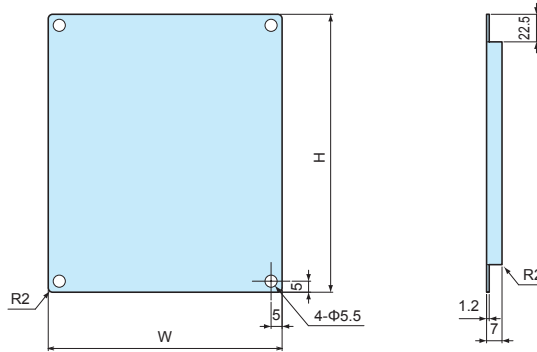
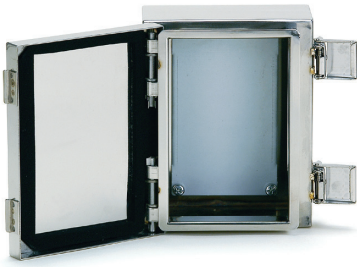

Product no. / Dimensions

Product no.	W	H	Suitable box
SSC1215	76	126	SSM • SLM • SSB • SLB 1215
SSC1515	106	126	SSM • SLM • SSB • SLB 1515
SSC1522	106	196	SSM • SLM • SSB • SLB 1522
SSC2020	156	176	SSM • SLM • SSB • SLB 2020
SSC2028	156	256	SSM • SLM • SSB • SLB 2028
SSC2233	176	306	SSM • SLM • SSB • SLB 2233
SSC3040	256	376	SSM • SLM • SSB • SLB 3040

■ Material / Finish : Steel SECC t = 1.2 / Zinc coated Included screws : M4-8 Pan head with spring washer / Trivalent chromate x 4 pcs

FDR SERIES

DIN-RAIL



Product no. / Dimensions

Product no.	L	Suitable box
FDR- 128	128	SSM • SLM • SSB • SLB 1215 / 1515
FDR-B176	176	SSM • SLM • SSB • SLB 2020
FDR-B196	196	SSM • SLM • SSB • SLB 1522
FDR-B256	256	SSM • SLM • SSB • SLB 2028
FDR-B303	303	SSM • SLM • SSB • SLB 2233
FDR-B376	376	SSM • SLM • SSB • SLB 3040

■ Material / Finish : Extruded aluminium A6063S-T5 / Silver anodized

SSM-G SERIES**GASKET for SSM • SLM**

■ DXF/DWG/PDF drawings available on our website.

Product no. / Dimensions

Product no.	Suitable box
SSM-G1215	SSM • SLM 1215
SSM-G1515	SSM • SLM 1515
SSM-G1522	SSM • SLM 1522
SSM-G2020	SSM • SLM 2020
SSM-G2028	SSM • SLM 2028
SSM-G2233	SSM • SLM 2233
SSM-G3040	SSM • SLM 3040

■ Material : EPDM t = 5.0

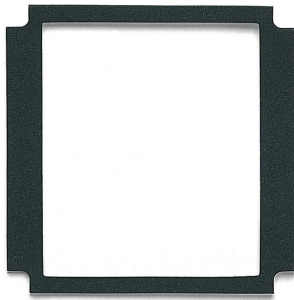
SSB-G SERIES**GASKET for SSB • SLB**

■ DXF/DWG/PDF drawings available on our website.

Product no. / Dimensions

Product no.	Suitable box
SSB-G1215	SSB • SLB 1215
SSB-G1515	SSB • SLB 1515
SSB-G1522	SSB • SLB 1522
SSB-G2020	SSB • SLB 2020
SSB-G2028	SSB • SLB 2028
SSB-G2233	SSB • SLB 2233
SSB-G3040	SSB • SLB 3040

■ Material : EPDM t = 5.0

SSK SERIES POLE MOUNTING BRACKET

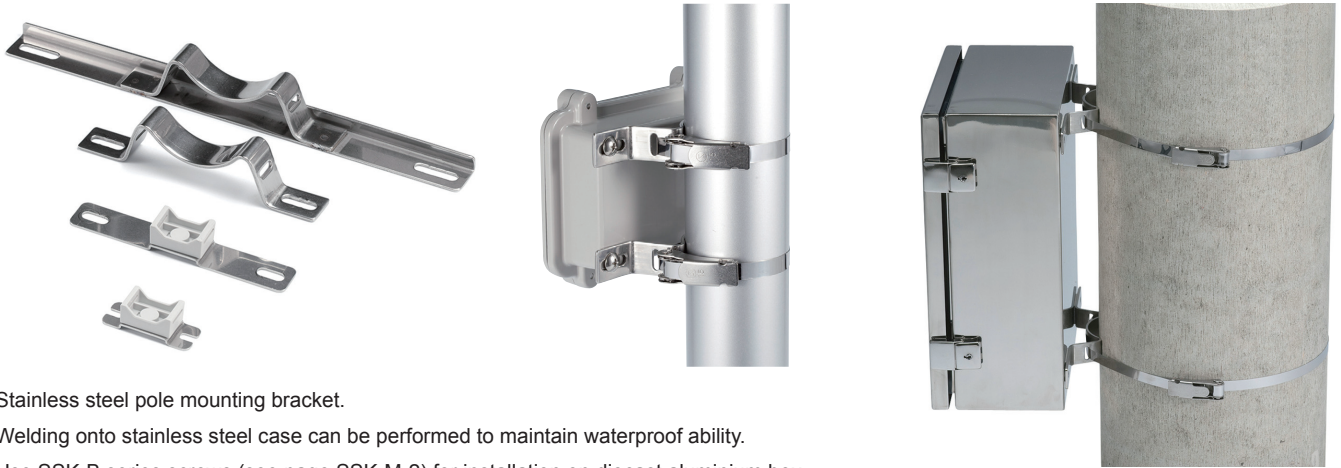

- Stainless steel pole mounting bracket.
- Welding onto stainless steel case can be performed to maintain waterproof ability.
- Use SSK-B series screws (see page SSK-M-2) for installation on diecast aluminium box.
- Use PKB mounting belt (see page PKB-1) for installation onto a pole.

SSK dimensions

■ DXF/DWG/PDF drawings available on our website.

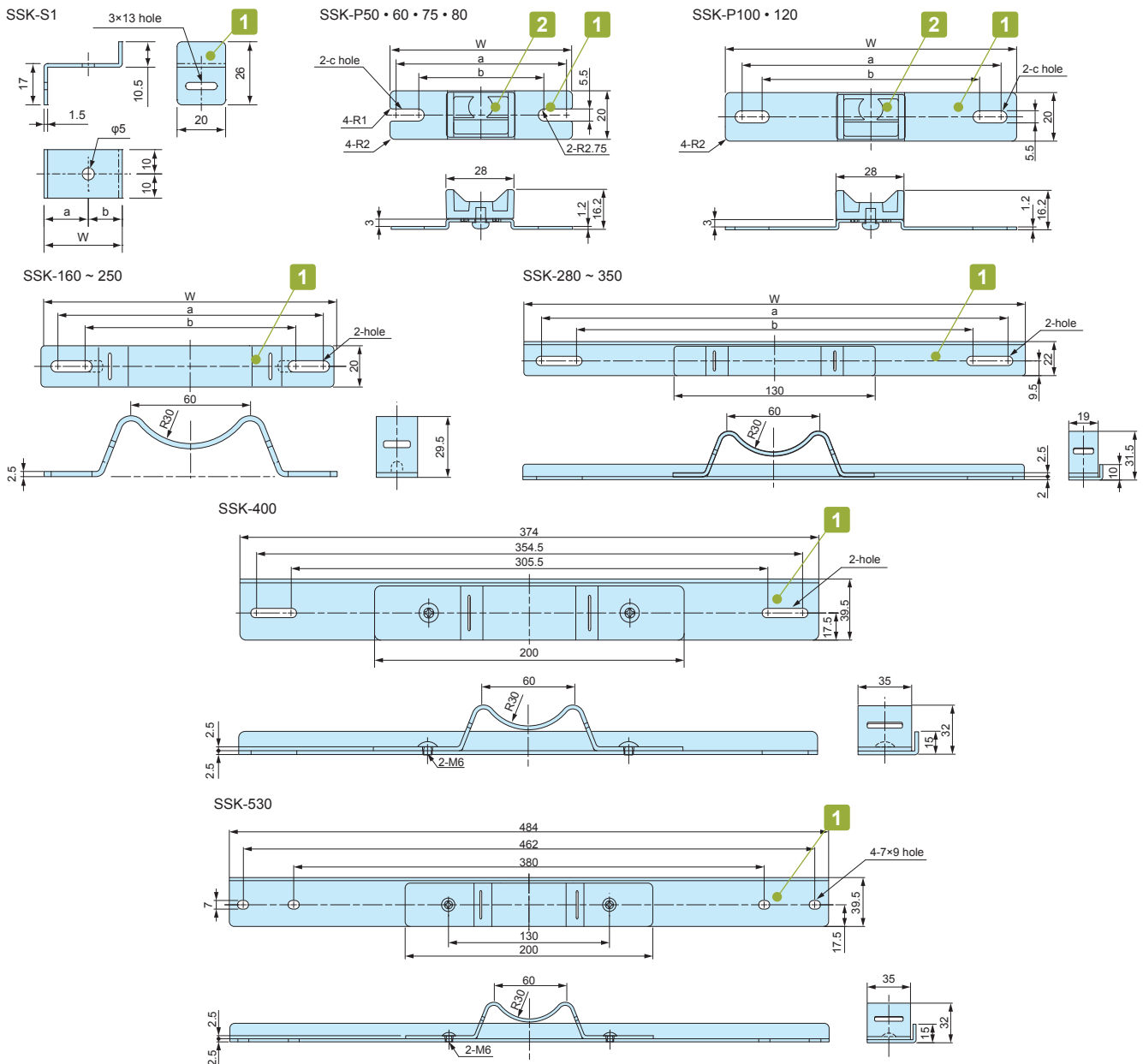

Components

No.	Part name	Pcs	Material	Color / Finish
1	Bracket	2	Stainless steel SUS304	Barrel finish
2	Mounting bracket (SSK-P models only)	2	ASA UL94HB	White gray

Product no. / Dimensions

Product no.	W	a	b	c	Suitable mounting belt	Pack of
SSK-S1	32.25	18.25	14	—	PKB-10PM, 10P, PKB-10S	4
SSK-P50	50	44.5	37.5	5.5× 9	PKB-10PM, 10P, PKB-10S	2
SSK-P60	60	54.5	47.5	5.5× 9	PKB-10PM, 10P, PKB-10S	2
SSK-P75	75	69.5	55.5	5.5×12.5	PKB-10PM, 10P, PKB-10S	2
SSK-P80	80	74.5	64.5	5.5×10.5	PKB-10PM, 10P, PKB-10S	2
SSK-P100	100	88.1	76.5	5.5×11.3	PKB-10PM, 10P, PKB-10S	2
SSK-P120	120	106.5	88.5	5.5×14.5	PKB-10PM, 10P, PKB-10S	2
SSK-160	142	129.5	106.5	—	PKB-10PM, 10P, PKB-10S	2
SSK-170	152	142.3	101	—	PKB-10PM, 10P, PKB-10S	2
SSK-200	174	161.5	112.5	—	PKB-10PM, 10P, PKB-10S	2
SSK-210	192	180.5	131.5	—	PKB-10PM, 10P, PKB-10S	2
SSK-250	230	215.5	166.5	—	PKB-10PM, 10P, PKB-10S	2
SSK-280	260	244.5	195.5	—	PKB-10PM, 10P, PKB-10S	2
SSK-300	280	264.5	215.5	—	PKB-10PM, 10P, PKB-10S	2
SSK-350	324	302.5	253.5	—	PKB-10PM, 10P, PKB-10S	2
SSK-400	374	354.5	305.5	—	PKB-20S	2
SSK-530	484	462	380	7×9	PKB-20S	2

SSK-B SERIES

MOUNTING SCREW SET for SSK

- Mounting screw set for use with SSK pole mounting bracket.
- See below chart for appropriate screw / box combination.
- Material / Finish : Stainless steel / Unfinished.

Product no. / Dimensions

Product no.	Included screws	Suitable box	Pcs
SSK-B4-15N	M4-15 Pan head with nut	AW5-4-7 ~ AW8-5-18	4
SSK-B4-25N	M4-25 Pan head with nut	BDN9-9-6, BDN10-14-7	4
SSK-B5-8T	M5-8 Binding head tapping	HQ series	4
SSK-B5-15N	M5-15 Pan head with nut	AW9-9-10 ~ AW21-9-31	4
SSK-B5-25N	M5-25 Pan head with nut	BDN12-22-8, BDN16-26-9	4

- Installation Example

M5 thread fastening

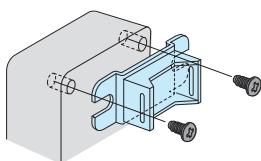

SSK-B5-8T

M4/M5 Pan head with nut fastening

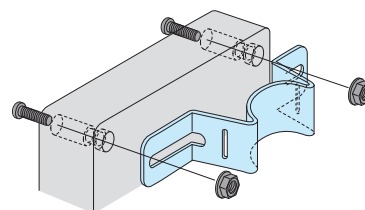

SSK-B4-15N SSK-B4-25N
 SSK-B5-15N SSK-B5-25N
 SSK-B5-35N SSK-B6-40N

POLE MOUNTING BRACKET / SCREW SET MATCHING CHART

BDN series

	Box Product no.	SSK Product no.		Screw set Product no.
		Vertical mount	Horizontal mount	
BDN	9-9-6	SSK-P75	SSK-P100	SSK-B4-25-N
	10-14-7	SSK-P80	SSK-160	SSK-B4-25-N
	12-22-8	SSK-P100	SSK-250	SSK-B5-25-N
	16-26-9	SSK-160	SSK-280	SSK-B5-25-N

HQ series

	Box Product no.	SSK Product no.		Screw set Product no.
		Vertical mount	Horizontal mount	
HQ	10-10-5 • 10-10-7	SSK-P50	—	SSK-B5-8T
	15-10-5 • 15-10-8	SSK-P80	SSK-160	SSK-B5-8T
	15-11-3	SSK-P100	SSK-160	SSK-B5-8T
	16-16-6 • 16-16-8	SSK-170	SSK-170	SSK-B5-8T
	19-10-5 • 19-10-7	—	SSK-200	SSK-B5-8T
	20-15-3 • 20-15-5 • 20-15-9	SSK-160	SSK-210	SSK-B5-8T
	26-18-6	SSK-200	SSK-280	SSK-B5-8T
	27-17-7 • 27-17-10	SSK-170	SSK-280	SSK-B5-8T

SSM • SSB series ■ Installation should be done by welding.

	Box Product no.			SSK Product no.	
				Vertical mount	Horizontal mount
SSM SSB	121508			SSK-S1	—
	151508	152206	152210	SSK-160	—
	202010	202806		SSK-210	—
	202812	223312			
	304015			SSK-300	—

■ SSK bracket is different depending on mount type (Vertical or Horizontal).

Vertical mount
(Longer vertical side)

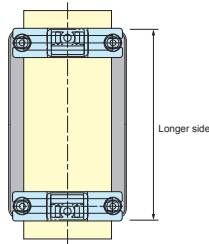

Horizontal mount
(Longer horizontal side)

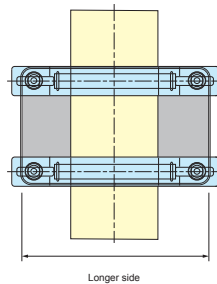

AW series

	Box Product no.	SSK Product no.		Screw set Product no.
		Vertical mount	Horizontal mount	
AW	5-4-7	—	SSK-P100	SSK-B4-15N
	5-4-9	—	SSK-P120	SSK-B4-15N
	5-4-11	—	SSK-160	SSK-B4-15N
	5-4-14	—	SSK-200	SSK-B4-15N
	7-7-8	SSK-P50	SSK-P120	SSK-B4-15N
	7-7-11	SSK-P50	SSK-160	SSK-B4-15N
	7-7-15	SSK-P50	SSK-210	SSK-B4-15N
	7-7-20	SSK-P50	SSK-250	SSK-B4-15N
	7-7-25	SSK-P50	SSK-300	SSK-B4-15N
	8-5-9	SSK-P75	SSK-160	SSK-B4-15N
	8-5-12	SSK-P75	SSK-160	SSK-B4-15N
	8-5-14	SSK-P75	SSK-200	SSK-B4-15N
	8-5-18	SSK-P75	SSK-250	SSK-B4-15N
	9-9-10	SSK-P75	SSK-160	SSK-B5-15N
	9-9-13	SSK-P75	SSK-170	SSK-B5-15N
	9-9-17	SSK-P75	SSK-250	SSK-B5-15N
	9-9-22	SSK-P75	SSK-280	SSK-B5-15N
	9-9-28	SSK-P75	SSK-350	SSK-B5-15N
	11-6-11	SSK-P100	SSK-160	SSK-B5-15N
	11-6-15	SSK-P100	SSK-210	SSK-B5-15N
	11-6-19	SSK-P100	SSK-250	SSK-B5-15N
	11-6-24	SSK-P100	SSK-300	SSK-B5-15N
	12-8-11	SSK-P120	SSK-160	SSK-B5-15N
	12-8-14	SSK-P120	SSK-200	SSK-B5-15N
	12-8-17	SSK-P120	SSK-250	SSK-B5-15N
	12-8-22	SSK-P120	SSK-280	SSK-B5-15N
	16-9-14	SSK-160	SSK-200	SSK-B5-15N
	16-9-18	SSK-160	SSK-250	SSK-B5-15N
	16-9-23	SSK-160	SSK-280	SSK-B5-15N
	16-9-28	SSK-160	SSK-350	SSK-B5-15N
	21-9-17	SSK-210	SSK-250	SSK-B5-15N
21-9-21	SSK-210	SSK-280	SSK-B5-15N	
21-9-26	SSK-210	SSK-350	SSK-B5-15N	
21-9-31	SSK-210	SSK-400	SSK-B5-15N	



PKB-10PM, 10P



PKB-10S, 20S

- New shorter belt type PKB-10PM is available for $\phi 25$ to $\phi 60$ mm poles. Other belt types are for $\phi 60$ to $\phi 400$ mm poles.
- Designed for one time use only (not reusable).
- Strong stainless steel clamping type and easy installation plastic type are available.
- Use SSK mounting bracket for installation onto a pole.
- Drawings below are reference examples only. DXF/DWG/PDF drawings available on our website.

PKB dimensions

PKB-10PM, 10P

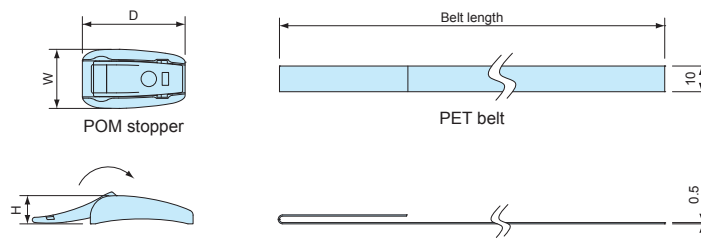

PKB-10S

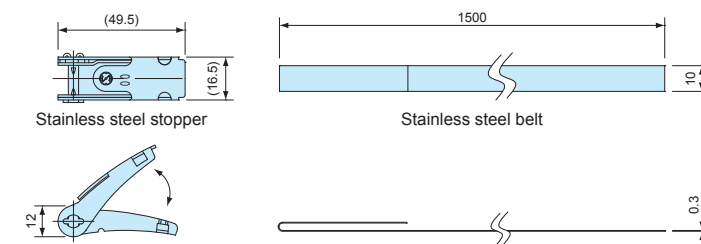

PKB-20S

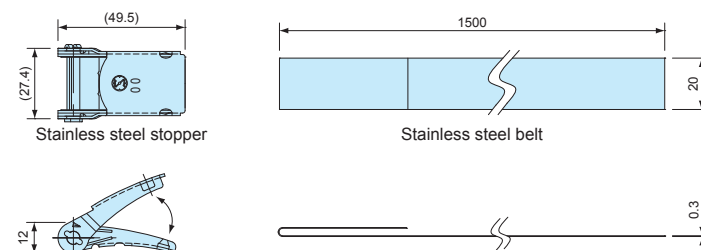

Components

Part name	Pcs	Material	Color / Finish
Stopper	2	POM • Stainless steel SUS304	Black • Barrel finish
Belt	2	PET • Stainless steel SUS430	Gray • Bright Annealed finish

Product no. / Dimensions

Product no.	W	D	H	Belt material	Belt length	Tensile strength (horizontal)	Weight (g)	Pack of
NEW PKB-10PM	24	23	11	PET	500mm	0.8kN	14	2
PKB-10P	23	40	11	PET	1,500mm	1.3kN	31.8	2
PKB-10S	—	—	—	Stainless steel	1,500mm	1.4kN	101.6	2
PKB-20S	—	—	—	Stainless steel	1,500mm	2.9kN	182.2	2

SZ SERIES

WATERPROOF WASHER

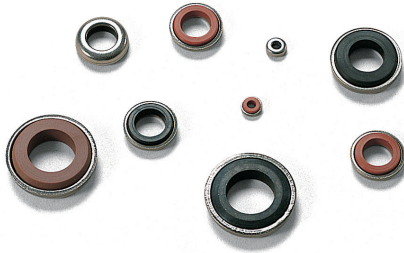

- Waterproof washer for screwing onto waterproof boxes.
- NBR sealing material has superior oil resistance (N models only) .
- Silicone sealing material has wider operating temperature with superior temperature and water resistance (S models only).

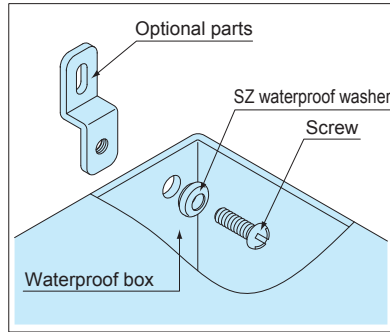
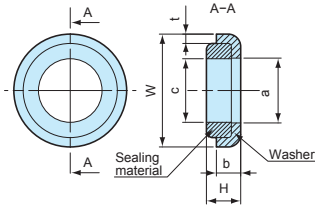

Technical Data
Water pressure resistance: M3 ~ M10 : 200kg/cm ² 5min M12 ~ M16 : 100kg/cm ² 5min

■ Shape of the sealing material vary by product.

Product no. / Dimensions

Product no.	W	H	a	b	c	t	Washer material	Sealing material	Color	Screw size	Pack of
SZ- 3N	7	2.7	3.2	2.2	3.1	0.5	SUS304	NBR	Black	M 3	1
SZ- 3S	7	2.7	3.2	2.2	3.1	0.5	SUS304	Silicone	Brown	M 3	1
SZ- 4N	8	2.8	4.2	2.1	4.1	0.5	SUS304	NBR	Black	M 4	1
SZ- 4S	8	2.8	4.2	2.1	4.1	0.5	SUS304	Silicone	Brown	M 4	1
SZ- 5N	9.5	3.6	5.2	2.7	5.1	0.8	SUS304	NBR	Black	M 5	1
SZ- 5S	9.5	3.6	5.2	2.7	5.1	0.8	SUS304	Silicone	Brown	M 5	1
SZ- 6N	11.5	4	6.2	3	6.2	1	SUS304	NBR	Black	M 6	1
SZ- 6S	11.5	4	6.2	3	6.2	1	SUS304	Silicone	Brown	M 6	1
SZ- 8N	15.2	3.8	8.2	3.2	8.2	1	SUS304	NBR	Black	M 8	1
SZ- 8S	15.2	3.8	8.2	3.2	8.2	1	SUS304	Silicone	Brown	M 8	1
SZ-10N	18	5.3	10.2	4	10.2	1.5	SUS304	NBR	Black	M10	1
SZ-10S	18	5.3	10.2	4	10.2	1.5	SUS304	Silicone	Brown	M10	1
SZ-12N	24	6.1	14.2	4.8	12.2	1.5	SUS304	NBR	Black	M12	1
SZ-12S	24	6.1	14.2	4.8	12.2	1.5	SUS304	Silicone	Brown	M12	1
SZ-16N	30	6.8	18.4	5.3	16	1.9	SUS304	NBR	Black	M16	1
SZ-16S	30	6.8	18.4	5.3	16	1.9	SUS304	Silicone	Brown	M16	1



- Weatherproof cable gland equipped with high ultraviolet and degradation resistant silicone sealing insert and O-ring.
- Recommended to use outdoors where waterproofing is critical.

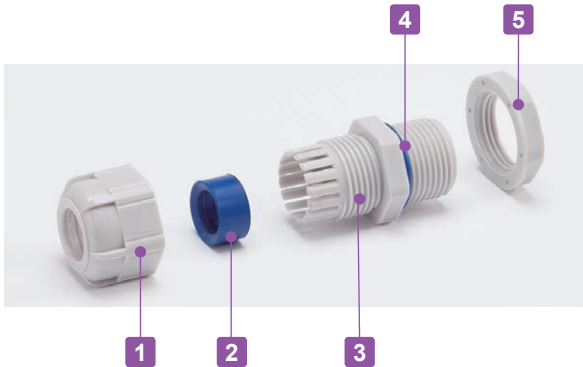

Components

■ PA = Polyamide

No.	Part name	Material
1	Cap	PA66 UL94V-2
2	Sealing insert	Silicone
3	Connector	PA66 UL94V-2
4	O-ring	Silicone
5	Nut	PA66 UL94V-2

RMW dimensions

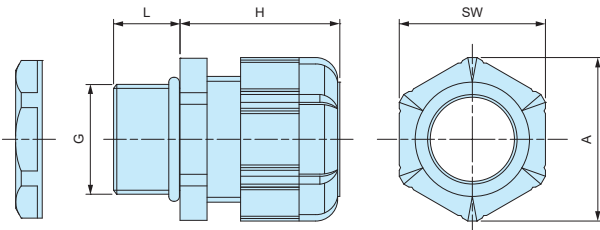

Technical Data

Protection class: IP67
Operating temperature: -20°C ~ +80°C

- DXF/DWG/PDF drawings available on our website.
- Lock nut is not included for RMW10S-6.
Please drill a proper thread hole into the enclosure for installation.

Product no. / Dimensions

Product no.		G		Cable range		L	H Max	SW	A	Pack of
● Black	● Light gray	Thread size	Mounting hole	Min	Max					
RMW8L-2.5B	RMW8L-2.5S	M8×1.25	Φ8.2	1	2.5	13	19.5	11.8	13.5	1
RMW8L-4B	RMW8L-4S	M8×1.25	Φ8.2	2.5	4	13	19.5	11.8	13.5	1
RMW10S-6B	RMW10S-6S	M10×1.5	—	3	6	8	20.5	13	14.4	1
RMW10L-6B	RMW10L-6S	M10×1.5	Φ10.2	3	6	13	20.5	13	14.4	1
RMW12S-7B	RMW12S-7S	M12×1.5	Φ12.2	3.5	7	9	20.5	16	17.6	1
RMW12L-7B	RMW12L-7S	M12×1.5	Φ12.2	3.5	7	14.5	20.5	16	17.7	1
RMW16S-8B	RMW16S-8S	M16×1.5	Φ16.2	4	8	9	23.5	19	21	1
RMW16L-8B	RMW16L-8S	M16×1.5	Φ16.2	4	8	15	24	19	21	1
RMW20S-12B	RMW20S-12S	M20×1.5	Φ20.2	6	12	10	29	24	26.2	1
RMW20L-12B	RMW20L-12S	M20×1.5	Φ20.2	6	12	15	28.5	24	26.2	1
RMW25L-17B	RMW25L-17S	M25×1.5	Φ25.2	11	17	15	35	33	36.2	1
RMW32L-21B	RMW32L-21S	M32×1.5	Φ32.3	13	21	15	38	36	39.5	1
RMW40L-27B	RMW40L-27S	M40×1.5	Φ40.3	18	27	18	43.5	45.7	50.5	1
RMW50L-38B	RMW50L-38S	M50×1.5	Φ50.4	27	38	20	50.5	60	66.5	1
RMW8L-2.5B-P	RMW8L-2.5S-P	M8×1.25	Φ 8.2	1	2.5	13	19.5	11.8	13.5	100
RMW8L-4B-P	RMW8L-4S-P	M8×1.25	Φ 8.2	2.5	4	13	19.5	11.8	13.5	100
RMW10L-6B-P	RMW10L-6S-P	M10×1.5	Φ10.2	3	6	13	20.5	13	14.4	100
RMW12S-7B-P	RMW12S-7S-P	M12×1.5	Φ12.2	3.5	7	9	20.5	16	17.6	100
RMW12L-7B-P	RMW12L-7S-P	M12×1.5	Φ12.2	3.5	7	14.5	20.5	16	17.7	100
RMW16S-8B-P	RMW16S-8S-P	M16×1.5	Φ16.2	4	8	9	23.5	19	21	100
RMW16L-8B-P	RMW16L-8S-P	M16×1.5	Φ16.2	4	8	15	24	19	21	100
RMW20S-12B-P	RMW20S-12S-P	M20×1.5	Φ20.2	6	12	10	29	24	26.2	100
RMW20L-12B-P	RMW20L-12S-P	M20×1.5	Φ20.2	6	12	15	28.5	24	26.2	100
RMW25L-17B-P	RMW25L-17S-P	M25×1.5	Φ25.2	11	17	15	35	33	36.2	100

RMW series silicone sealing insert weatherproof test report

Object: Cut into a piece of the silicone sealing insert from RMW series and attach it onto an aluminium plate.
 For comparison, NBR sealing insert from our RM and EPDM sealing insert from another manufacturer is also attached for comparison purposes.

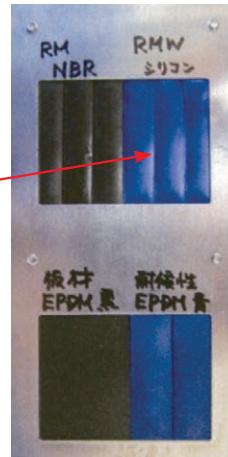

Before



After

Testing conditions

Equipment : 7.5kW Super Xenon Weather Meter SX75 (Suga Test Instruments Co., Ltd.- <http://www.sugatest.co.jp/english/>)
Conditions : JIS B7754 : 1991

Testing with an authorized Xenon arc lamp weathering test equipment under the conditions denoted below.

Irradiance : 180W/m² at 300-400nm

Black Panel Temperature : 63±3°C Humidity Range : 50±10%

Cycle Conditions : 120 minutes cycle (18 minutes irradiation + water spray - 102 minutes irradiation)

2,000 hours (equivalent to a period of 4 years under natural conditions)

Time period :

Total radiant exposure : 1296MJ/m²

Test result (visual / touch inspection)

Silicone sealing insert material : No cracks, no gloss transition, no powder - no appearance change at all. Flexibility remains unchanged.

Before



After



NBR material from our RM series : Lost glossiness on the surface and material is stiffened.

Before



After



EPDM material from weatherproof cable gland of another manufacturer : Cracked, color drastically faded and powder appeared on the surface.

Before

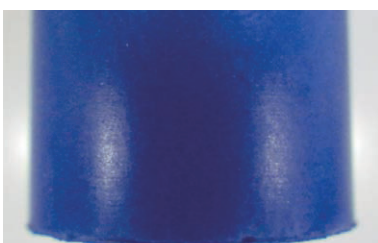

After

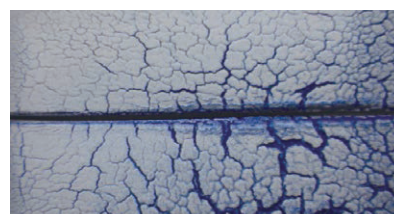

RM SERIES

POLYAMIDE CABLE GLAND

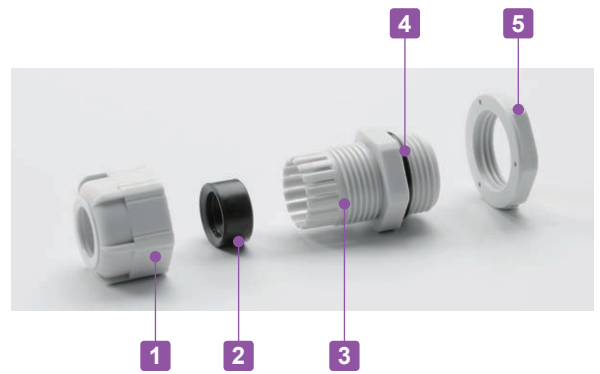

- Low cost cable glands made from polyamide material.
- Wide selection, for M8 ~ M63, suitable for $\Phi 1\text{mm} \sim \Phi 44\text{ mm}$ cable.
- High oil resistant NBR rubber sealing and O-ring.
- IP67 protection class.

Components

■ PA = Polyamide

No.	Part name	Material
1	Cap	PA66 UL94V-2
2	Sealing insert	NBR
3	Connector	PA66 UL94V-2
4	O-ring	NBR
5	Lock nut	PA66 UL94V-2

RM dimensions

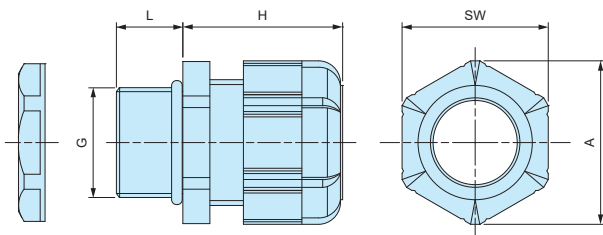

Technical Data

Protection class: IP67
Operating temperature: -20°C ~ +80°C

- DXF/DWG/PDF drawings available on our website.
- Lock nut is not included for RM8S-2.5, 8S-4, and 10S-6 models.
Please drill a proper thread hole into the enclosure for installation.

Product no. / Dimensions

Product no.		G		Cable range		L	H Max	SW	A	Pack of
● Black	● Light gray	Thread size	Mounting hole	Min	Max					
RM8S-2.5B	RM8S-2.5S	M8×1.25	—	1	2.5	7.5	19.5	11.8	13.5	1
RM8L-2.5B	RM8L-2.5S	M8×1.25	Φ8.2	1	2.5	13	19.5	11.8	13.5	1
RM8S-4B	RM8S-4S	M8×1.25	—	2.5	4	7.5	19.5	11.8	13.5	1
RM8L-4B	RM8L-4S	M8×1.25	Φ8.2	2.5	4	13	19.5	11.8	13.5	1
RM10S-6B	RM10S-6S	M10×1.5	—	3	6	8	20.5	13	14.4	1
RM10L-6B	RM10L-6S	M10×1.5	Φ10.2	3	6	13	20.5	13	14.4	1
RM12S-7B	RM12S-7S	M12×1.5	Φ12.2	3.5	7	9	20.5	16	17.6	1
RM12L-7B	RM12L-7S	M12×1.5	Φ12.2	3.5	7	14.5	20.5	16	17.7	1
RM16S-8B	RM16S-8S	M16×1.5	Φ16.2	4	8	9	23.5	19	21	1
RM16L-8B	RM16L-8S	M16×1.5	Φ16.2	4	8	15	24	19	21	1
RM20S-12B	RM20S-12S	M20×1.5	Φ20.2	6	12	10	29	24	26.2	1
RM20L-12B	RM20L-12S	M20×1.5	Φ20.2	6	12	15	28.5	24	26.2	1
RM25L-17B	RM25L-17S	M25×1.5	Φ25.2	11	17	15	35	33	36.2	1
RM32L-21B	RM32L-21S	M32×1.5	Φ32.3	13	21	15	38	36	39.5	1
RM40L-27B	RM40L-27S	M40×1.5	Φ40.3	18	27	18	43.5	45.7	50.5	1
RM50L-38B	RM50L-38S	M50×1.5	Φ50.4	27	38	20	50.5	60	66.5	1
RM63L-44B	RM63L-44S	M63×1.5	Φ63.4	37	44	20	53	68	75.5	1
RM8L-2.5B-P	RM8L-2.5S-P	M8×1.25	Φ8.2	1	2.5	13	19.5	11.8	13.5	100
RM8L-4B-P	RM8L-4S-P	M8×1.25	Φ8.2	2.5	4	13	19.5	11.8	13.5	100
RM10L-6B-P	RM10L-6S-P	M10×1.5	Φ10.2	3	6	13	20.5	13	14.4	100
RM12S-7B-P	RM12S-7S-P	M12×1.5	Φ12.2	3.5	7	9	20.5	16	17.6	100
RM12L-7B-P	RM12L-7S-P	M12×1.5	Φ12.2	3.5	7	14.5	20.5	16	17.7	100
RM16S-8B-P	RM16S-8S-P	M16×1.5	Φ16.2	4	8	9	23.5	19	21	100
RM16L-8B-P	RM16L-8S-P	M16×1.5	Φ16.2	4	8	15	24	19	21	100
RM20S-12B-P	RM20S-12S-P	M20×1.5	Φ20.2	6	12	10	29	24	26.2	100
RM20L-12B-P	RM20L-12S-P	M20×1.5	Φ20.2	6	12	15	28.5	24	26.2	100
RM25L-17B-P	RM25L-17S-P	M25×1.5	Φ25.2	11	17	15	35	33	36.2	100

RPG SERIES

POLYAMIDE CABLE GLAND



IP67

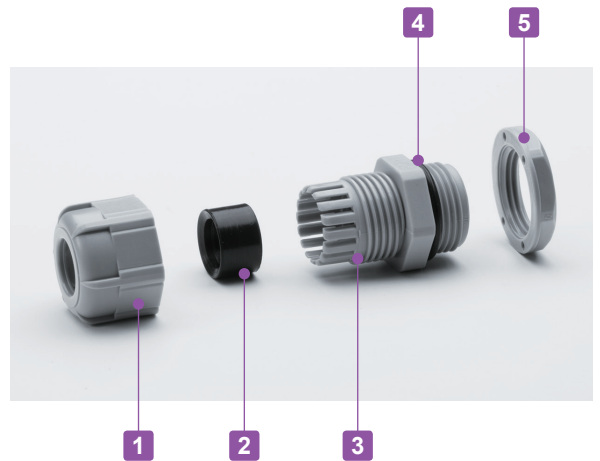

- Inexpensive cable glands made from polyamide material with PG threading.
- High oil resistant NBR rubber sealing and O-ring.
- IP67 protection class.

RPG dimensions

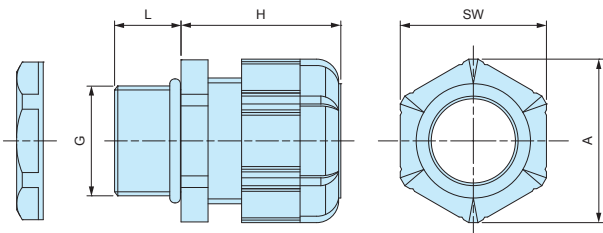

- DXF/DWG/PDF drawings available on our website.

Components

■ PA = Polyamide

No.	Part name	Material
1	Cap	PA66 UL94V-2
2	Sealing insert	NBR
3	Connector	PA66 UL94V-2
4	O-Ring	NBR
5	Lock-nut	PA66 UL94V-2

Technical Data

Protection class: IP67
Operating temperature: -20°C ~ +80°C

Product no. / Dimensions

Product no.		G			Cable range		L	H Max	SW	A	Pack of
● Black	● Gray	Thread size	Thread dia.	Mounting hole	Min	Max					
RPG7-7B	RPG7-7G	PG7	12.5	Φ12.7	3	7	9	20.5	16	17.7	1
RPG9-8B	RPG9-8G	PG9	15.2	Φ15.4	4	8	9	23.5	19	21	1
RPG11-10B	RPG11-10G	PG11	18.6	Φ18.8	5	10	9	26	22	24	1
RPG13.5-11B	RPG13.5-11G	PG13.5	20.4	Φ20.6	6	11	10	29	24	26.4	1
RPG16-14B	RPG16-14G	PG16	22.5	Φ22.7	8	14	10	30	26.7	29.5	1
RPG21-18B	RPG21-18G	PG21	28.3	Φ28.5	13	18	12	35	33	36.5	1
RPG29-25B	RPG29-25G	PG29	37	Φ37.2	18	25	12	41.5	42	46.5	1

SP SERIES

SEALING PLUG



SP dimensions

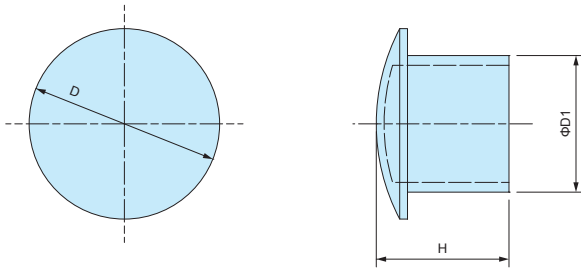

■ Material : Nylon

- Sealing plug for cable glands when not in use.
- Maintain a waterproof seal when plugged into the sealing insert on cable glands.

Product no. / Dimensions

Product no.	D	D1	H	Suitable cable glands	Pack of
SP-12	10.2	6	15.5	RMW12, RM12, RMW16, RM16, RPG7, RPG9	10
SP-16	15.6	9.5	15.5	RMW20, RM20, RPG11, RPG13.5	10
SP-20	19.6	13.5	16.5	RPG16	10
SP-25	24.4	17.5	17	RMW25, RM25, RMW32, RM32, RPG21	5
SP-40	32.5	24.5	17.5	RMW40, RM40, RPG29	5
SP-50	47.2	38.9	17.6	RMW50, RM50	5



- High water protection IP68 (1bar / 30min) polyamide cable gland.
- Wide selection, for M8 ~ M50, suitable for $\Phi 2.5\text{mm} \sim \Phi 42\text{mm}$ cable.
- Super tough and superior heat resistant PA6GF (glass fiber filled PA6) material on cap and connector.
- Safer halogen free, eco-friendly product.

Technical Data
Protection class: IP68 1bar / 30min
Operating temperature: -20°C ~ +100°C
Compliant with EN50262 Ver. A

AG Series

Thicker sealing insert evenly hold a cable by having a larger holding area.
Remains durable even after repeated tightening / loosening.

Lamellar insert type

If over-tightened, it can cause the rubber bush or cable to deform, which can allow water to seep in.

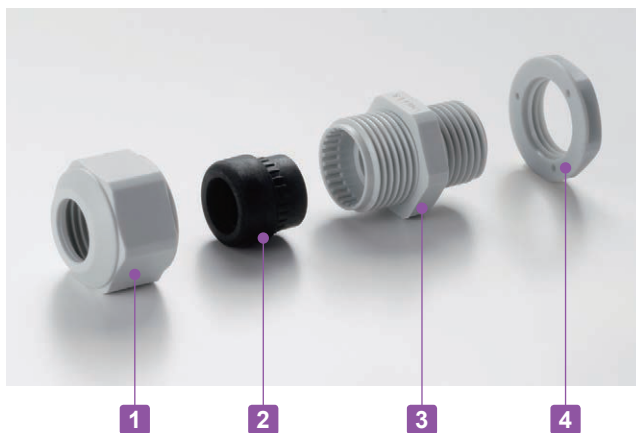
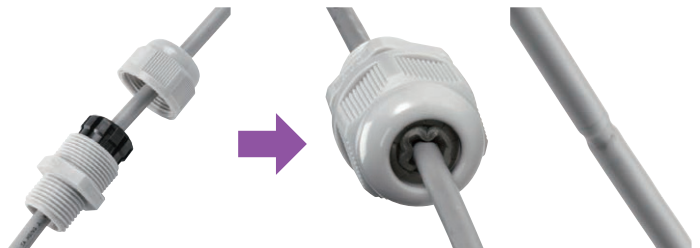
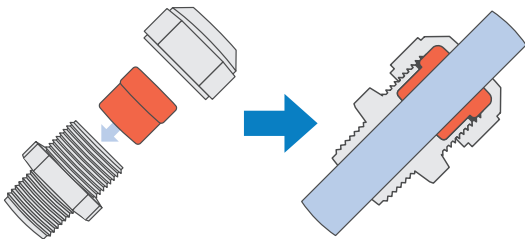

Components

■ PA6GF = Polyamide6 Glass Fiber Filled

No.	Part name	Material
1	Cap	PA6GF
2	Sealing insert	TPE
3	Connector	PA6GF
4	Lock nut	PA6

- Lock nut is not included for M8 and M10 sizes.
Please drill a proper thread hole into the enclosure for installation.

- Proper tightening torque varies by each cable diameter.
Tighten the cap until top of the sealing insert forms a small bead between the cap and the cable.



■ No optional sealing washer is required when installing on an even surface because of the built-in waterproof rib.

■ An optional sealing washer is required when installing on an uneven surface. (See page AGP-1 for more information on the optional sealing washer)

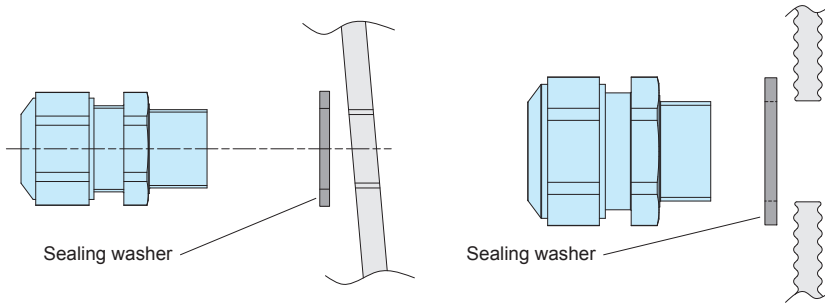

AG dimensions

■ DXF/DWG/PDF drawings available on our website.

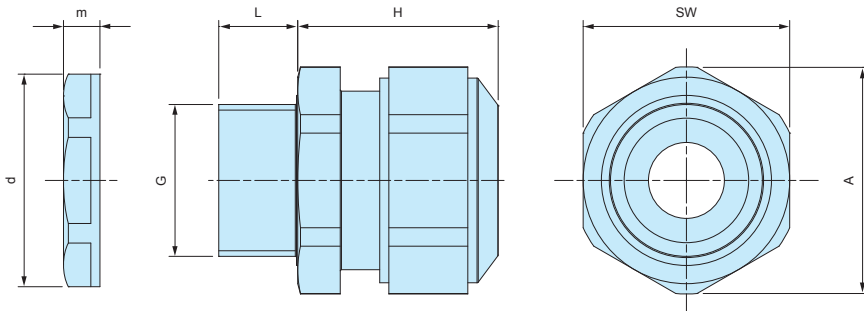

■ Lock nut is not included for M8 and M10 sizes. Please drill a proper thread hole into the enclosure for installation.

Product no. / Dimensions

Product no.		G		Cable range		L	H Max	SW	A	d	m	Pack of
● Black	● Light gray	Thread size	Mounting hole	Min	Max							
AG8-3.5B	AG8-3.5S	M8×1.0	—	2.5	3.5	10	17	12	13.2	—	—	1
AG8-5B	AG8-5S	M8×1.0	—	3.5	4.7	10	17	12	13.2	—	—	1
AG10-6B	AG10-6S	M10×1.0	—	4	6	10	19	15	16.5	—	—	1
AG12-5B	AG12-5S	M12×1.5	Φ12.2	3.5	4.7	12	23.5	17	18.7	18.8	5	1
AG12-6.5B	AG12-6.5S	M12×1.5	Φ12.2	5	6.5	12	23	17	18.7	18.8	5	1
AG12-8B	AG12-8S	M12×1.5	Φ12.2	6.5	7.8	12	23	17	18.7	18.8	5	1
AG16-10B	AG16-10S	M16×1.5	Φ16.2	8	10	12	26	21	23.1	24.3	5	1
AG20-15B	AG20-15S	M20×1.5	Φ20.2	11	15	13	27	27	29.7	29	6	1
AG25-16B	AG25-16S	M25×1.5	Φ25.2	12.5	16	13	34	34	37.4	36	6.7	1
AG25-20B	AG25-20S	M25×1.5	Φ25.2	16	20	13	34	34	37.4	36	6.7	1
AG32-25.5B	AG32-25.5S	M32×1.5	Φ32.3	21	25.5	15	36	41	45.6	46	8	1
AG40-28.5B	AG40-28.5S	M40×1.5	Φ40.3	24	28.5	15	41	50	55.4	53.5	9	1
AG40-33B	AG40-33S	M40×1.5	Φ40.3	28.5	33	15	41	50	55.4	53.5	9	1
AG50-37B	AG50-37S	M50×1.5	Φ50.4	33	37	16	45	60	65.5	66	9.6	1
AG50-42B	AG50-42S	M50×1.5	Φ50.4	37	42	16	45	60	65.5	66	9.6	1

AGP SERIES

SEALING WASHER for AG • AGSP

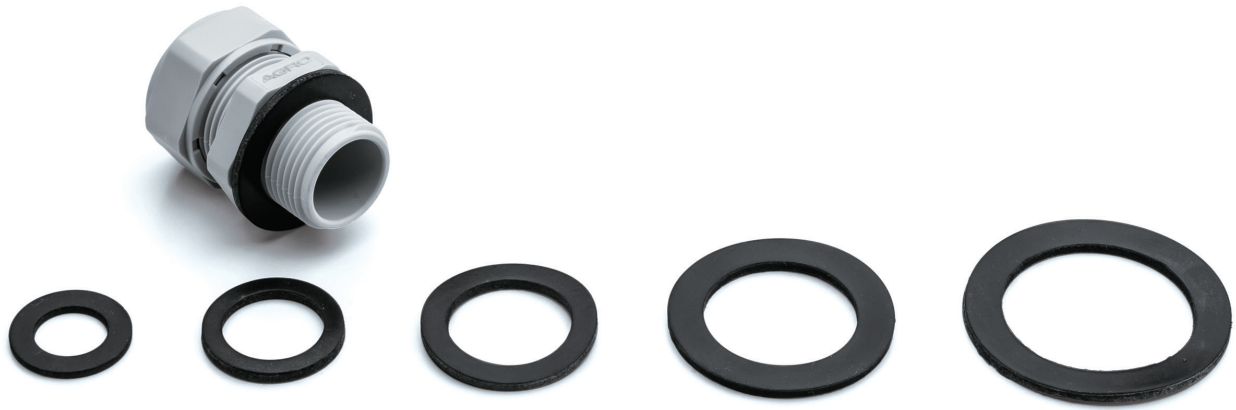

- Sealing washer for AG series.
- Made from oil resistant NBR material.
- Use in the case of installation on a rough or uneven surfaces.
- Selectable in 7 sizes (from M12 to M50)
- Sealing washer is not necessary for installation on flat surfaces.

AGP Dimensions

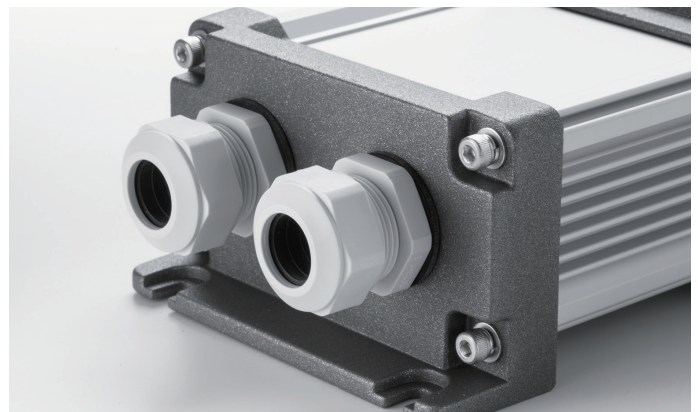
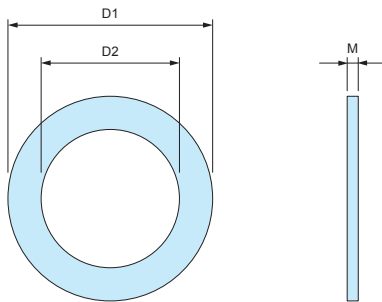

- Material : NBR

Product no. / Dimensions

Product no.	D1	D2	M	Suitable cable gland	Pack of
AGP-12	20	12	1.6	AG12	10
AGP-16	23.5	16.5	2.0	AG16	10
AGP-20	29	20	2.0	AG20	10
AGP-25	37	25	2.0	AG25	10
AGP-32	44	32	2.2	AG32	5
AGP-40	52	40	2.2	AG40	5
AGP-50	64	50	3.1	AG50	5

RSP SERIES

STRAIN RELIEF CABLE GLAND



■ DXF/DWG/PDF drawings available on our website.

RSP dimensions

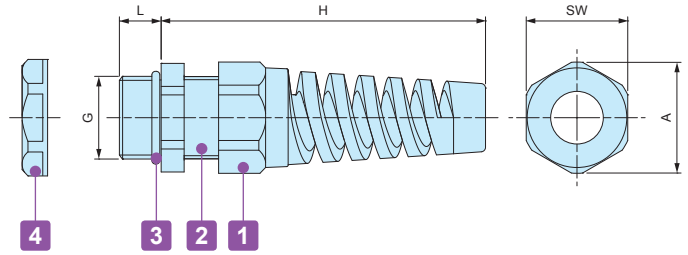

Components

■ PA = Polyamide

No.	Part name	Material
1	Strain relief cap	PA66 (UL94V-2)
-	Sealing insert	NBR
2	Connector	PA66 (UL94V-2)
3	O-ring	NBR
4	Lock- nut	PA66 (UL94V-2)

Technical Data
Protection class : IP67
Temperature range -20°C ~ +80°C

Product no. / Dimensions

Product no.		G		Cable range		L	H Max	SW	A	Pack of
● Black	● Light gray	Thread size	Mounting hole	Min	Max					
RSP12-6B	RSP12-6S	M12×1.5	φ12.2	3.5	6	9	62	16	17	1
RSP16-8B	RSP16-8S	M16×1.5	φ16.2	4	8	9	69	19.5	21	1
RSP20-11B	RSP20-11S	M20×1.5	φ20.2	6	11	10	82	24	26	1
RSP25-16B	RSP25-16S	M25×1.5	φ25.2	11	16	12	102	33	36	1

AGM SERIES

METAL CABLE GLAND

IP68



- High water protection IP68 (1bar / 30min) metal cable gland.
- Wide selection, for M6 ~ M50 and PG7 ~ PG16.
Suitable for $\Phi 2$ mm ~ $\Phi 42$ mm cable.

Technical Data
Protection class: IP68 1bar / 30min
Operating temperature: -40°C ~ +100°C
Compliant with EN50262 Ver. A

AGM Series

Thicker sealing insert evenly hold a cable by having a larger holding area. Remains durable even after repeated tightening / loosening.

Lamellar insert type

If over-tightened, it can cause the rubber bush or cable to deform, which can allow water to seep in.

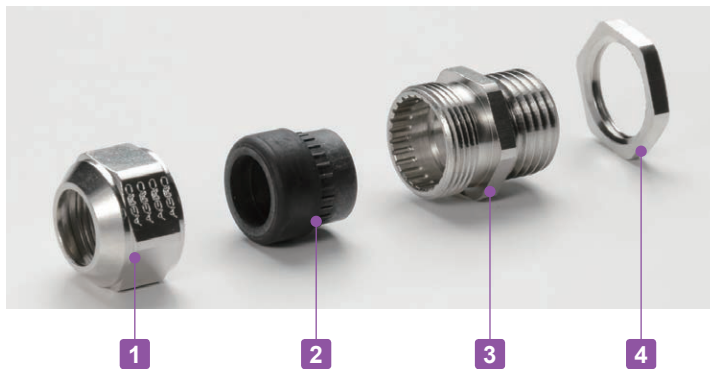
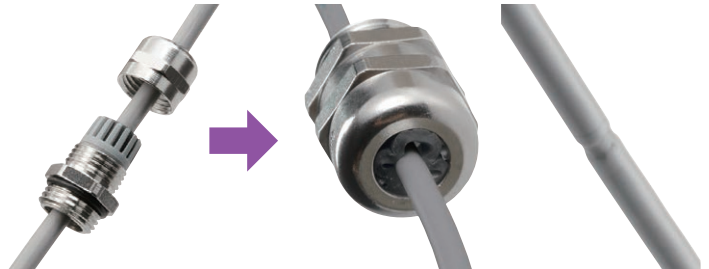
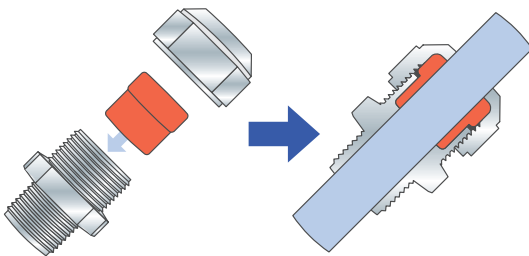

- Proper tightening torque varies by each cable diameter.
Tighten the cap until top of the sealing insert forms a small bead between the cap and the cable.



Components

No.	Part name	Material	Color / Finish
1	Cap	Brass	Nickel plated
2	Sealing insert	TPE	Black
3	Connector	Brass	Nickel plated
-	O-ring	NBR	Black
4	Lock nut	Brass	Nickel plated

AGM dimensions

DXF/DWG/PDF drawings available on our website.

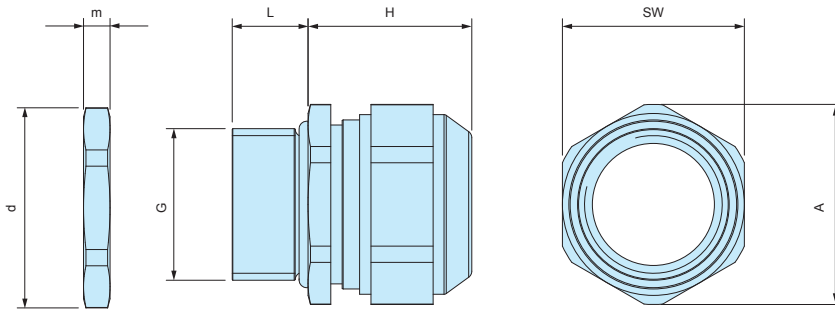

Product no. / Dimensions

Product no.	G			Cable range		L	H Max	SW	A	d	m	Pack of
	Thread size	Thread outer dia.	Mounting hole	Min	Max							
AGM6-2.5	M6×1.0	—	Φ6.2	2	2.5	8	12	8	9	10	2.8	1
AGM6-3	M6×1.0	—	Φ6.2	2.5	3.0	8	12	8	9	10	2.8	1
AGM6-3.5	M6×1.0	—	Φ6.2	3.0	3.5	8	12	8	9	10	2.8	1
AGM8-5	M8×1.25	—	Φ8.2	3.5	4.7	10	14	11	12	12	3	1
AGM10-6	M10×1.5	—	Φ10.2	4.0	6.0	10	15	13	14.3	14	2.8	1
AGM12-8	M12×1.5	—	Φ12.2	6.5	8.0	10	17	15	16.5	16.5	2.8	1
AGM16-10.5	M16×1.5	—	Φ16.2	8.0	10.5	10	21	18	20	21	3	1
AGM20-15	M20×1.5	—	Φ20.2	11.0	15.0	10	23	24	26.5	26.5	3.5	1
AGM25-20	M25×1.5	—	Φ25.2	16.0	20.0	11	28	30	33	33	4	1
AGM32-25.5	M32×1.5	—	Φ32.3	21.0	25.5	13	29.5	36	39.5	39.5	4	1
AGM40-28.5	M40×1.5	—	Φ40.3	24.0	28.5	13	32	46	50.7	51	5	1
AGM40-33	M40×1.5	—	Φ40.3	28.5	33.0	13	32	46	50.7	51	5	1
AGM50-37	M50×1.5	—	Φ50.4	33.0	37.0	14	34	55	59.7	60	5.5	1
AGM50-42	M50×1.5	—	Φ50.4	37.0	42.0	14	34	55	59.7	60	5.5	1
AGM7PG-5	PG7	12.5	Φ12.7	3.5	5.0	6	17	15	16.5	16.5	3	1
AGM9PG-6	PG9	15.2	Φ15.4	4.5	6.0	6	20	18	20	20	3	1
AGM11PG-8.5	PG11	18.6	Φ18.8	5.5	8.5	6	21	21	23	23.5	3	1
AGM13PG-11	PG13	20.4	Φ20.6	8.0	11.0	6	21	24	26.5	25.5	3	1
AGM16PG-14.5	PG16	22.5	Φ22.7	11	14.5	6	23	24	26.5	29	3	1

AGE SERIES

EMC SHIELDED CABLE GLAND



- Optimal contact spring provides excellent shield contact and the smallest possible transfer impedance.
- Clawed lock nut makes a good EMC shield contact possible on conductive enclosures.
- Shape of the contact spring not only allows for a large clamping range to the shield but also enables easy and faster installation and re-installation.
- 2-piece detachable sealing inserts can be adapted to the wider existing cable diameter on site.
(AGE12 available only with 1-piece sealing insert)

Technical Data	
Protection class :	IP68 2bar / 30min, IP69K
	20m depth immersion in 30 minutes
Operating temperature :	-60°C ~ +100°C
	Compliant with IEC62444 Var. A

Cable Range

No.	Sealing insert type	
	Assembled	Detached
AGE16-10.5	Φ 6 ~ Φ 7.5	Φ 7.5 ~ Φ10.5
AGE20-15	Φ 8 ~ Φ10.5	Φ10.5 ~ Φ15
AGE25-20	Φ12.5 ~ Φ15	Φ15 ~ Φ20
AGE32-25	Φ17 ~ Φ20	Φ20 ~ Φ25

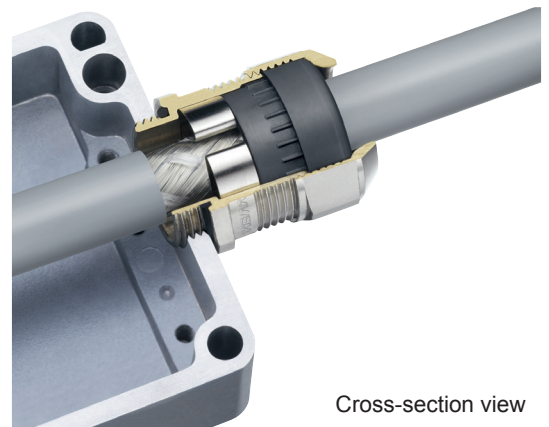
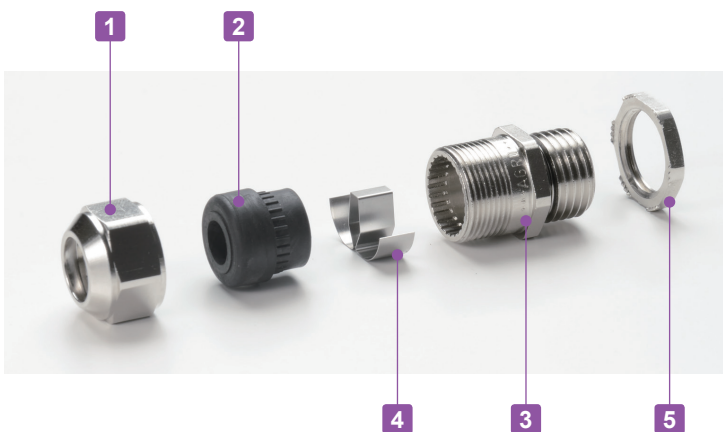
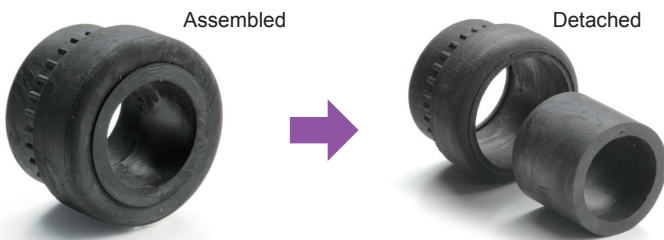

Cross-section view

Components

No.	Part name	Material	Color / Finish
1	Cap	Brass	Nickel plated
2	Sealing insert	TPE	Black
3	Connector	Brass	Nickel plated
4	Contact spring	Stainless steel	Unfinished
-	O-Ring	NBR	Black
5	Lock-nut	Brass	Nickel plated

INSTALLATION Instruction

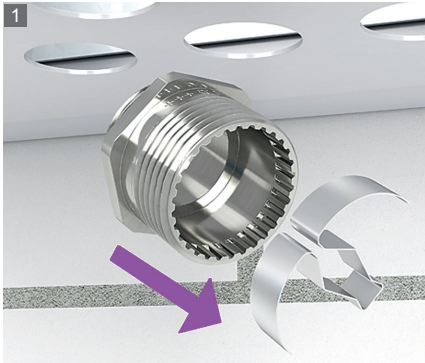

1 Remove the contact spring from the connector.



2 Install the connector onto the enclosure.



3 Strip the cable.

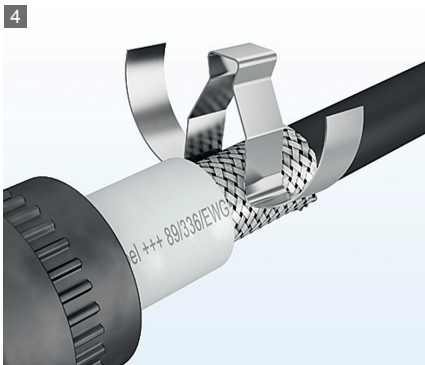

4 Clip the contact spring on the shielded cable.

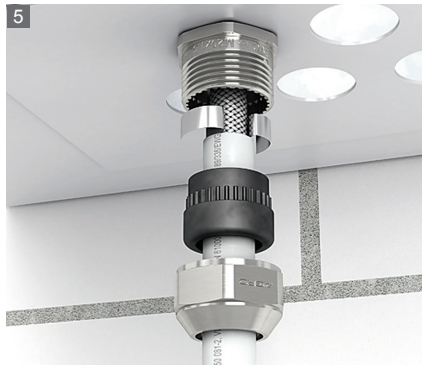

5 Pass the cable through the Sealing insert and cap.



6 Tighten the cap to complete.

AGE dimensions

■ DXF/DWG/PDF drawings available on our website.

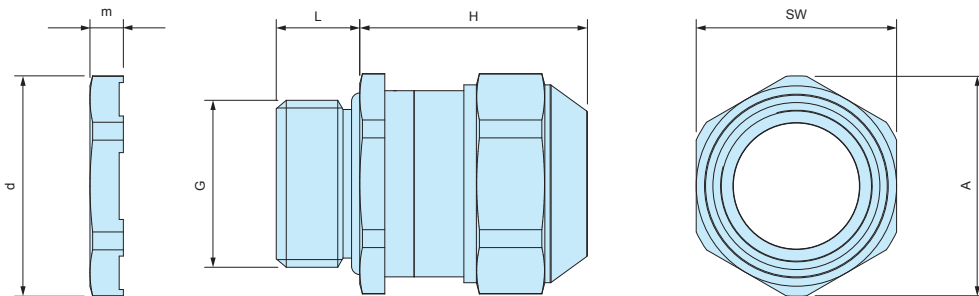

Product no. / Dimensions

Product no.	G		Cable range		L	H Max	SW	A	d	m	Pack of
	Thread size	Mounting hole	Min	Max							
AGE12-5	M12×1.5	Φ12.2	3.5	5.0	10	22	15	16.5	16.5	3.5	1
AGE12-6.5	M12×1.5	Φ12.2	5.0	6.5	10	22	15	16.5	16.5	3.5	1
AGE16-10.5	M16×1.5	Φ16.2	6.0	10.5	10	25	18	20	21	3.5	1
AGE20-15	M20×1.5	Φ20.2	8.0	15.0	10	27	24	26.5	26.5	4	1
AGE25-20	M25×1.5	Φ25.2	12.5	20.0	11	33	30	33	33	4	1
AGE32-25	M32×1.5	Φ32.3	17.0	25.0	13	34	36	39.5	39.5	5	1

AGH SERIES

HEAT RESISTANT METAL CABLE GLAND

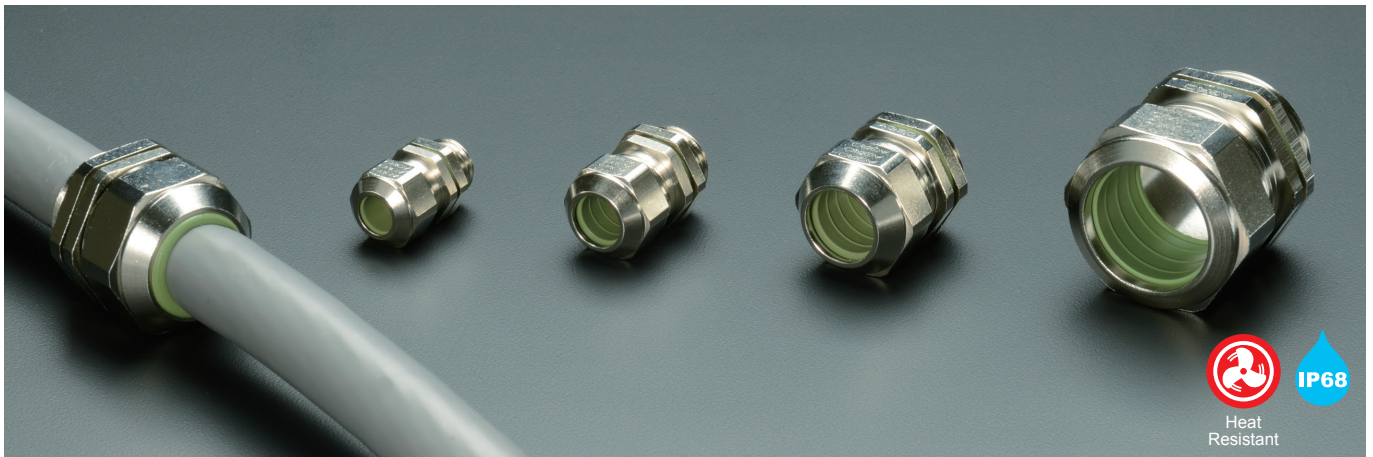

- Heat resistant sealing insert made of FPM material. Resistant up to 200°C
- IP68 1bar / 30min high performance waterproof cable gland.

Technical Data
Protection class : Protection class IP68 1bar / 30min 10m depth immersion in 30 minutes
Operating temperature : -40°C ~ +200°C
Compliant with EN50262 Var. A

AGH series

Thicker sealing insert evenly clasp onto the cable by having a larger area. Remains durable even after repeated tightening / loosening.

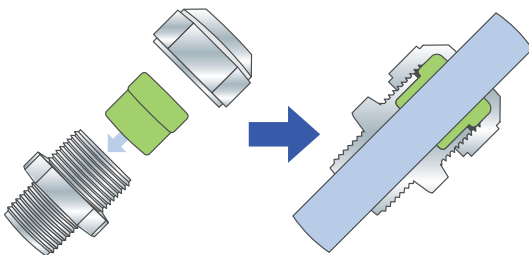

Conventional cable gland

If over-tightened, it can cause the rubber bush or cable to deform, which may allow water to seep in.

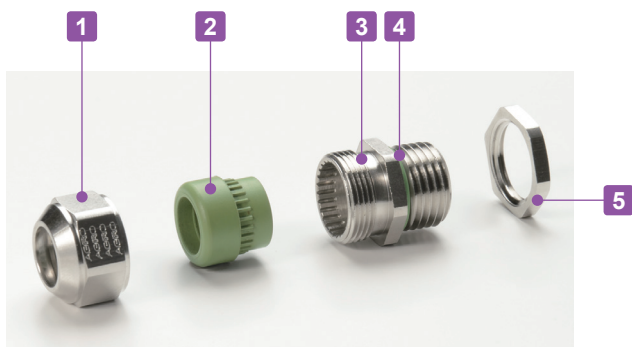
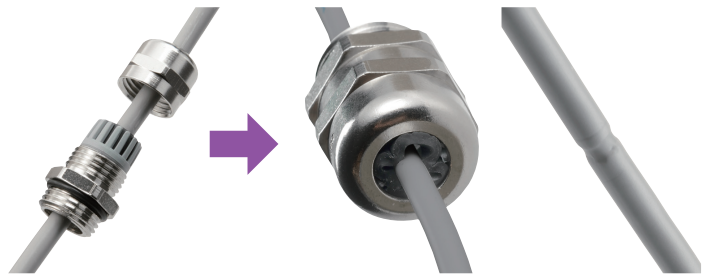

- Tightening torque varies depending on the cable diameter. Tighten until the sealing insert protrudes slightly from the cap.

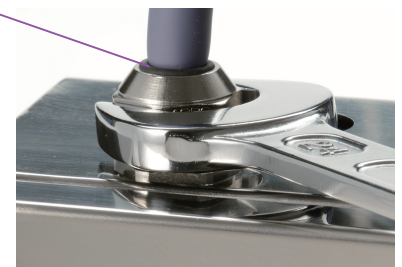

Components

No.	Part name	Material	Color / Finish
1	Cap	Brass	Nickel plated
2	Sealing insert	FPM	Green
3	Connector	Brass	Nickel plated
4	O-Ring	FPM	Green
5	Lock-nut	Brass	Nickel plated

AGH dimensions

■ DXF/DWG/PDF drawings available on our website.

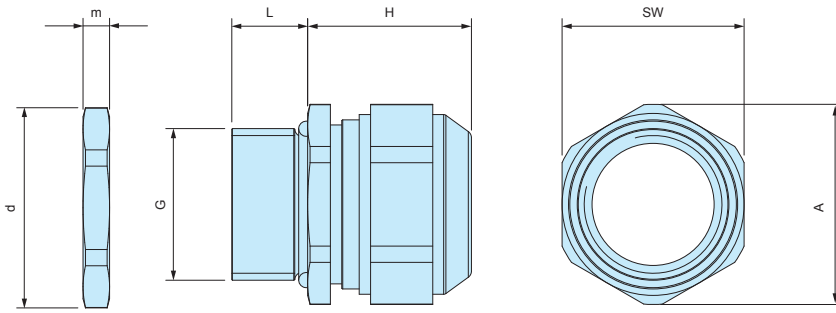

Product no. / Dimensions

Product no.	G		Cable range		L	H Max	SW	A	d	m	Pack of
	Thread size	Mounting hole	Min	Max							
AGH10-6	M10×1.5	Φ10.2	4.0	6.0	10	15	13	14.3	14.2	3	1
AGH12-8	M12×1.5	Φ12.2	6.5	8.0	10	17	15	16.5	16.5	3	1
AGH16-10.5	M16×1.5	Φ16.2	8.0	10.5	10	20	18	20	21	3	1
AGH20-15	M20×1.5	Φ20.2	11.0	15.0	10	23	24	26.5	26.3	3.5	1
AGH25-20	M25×1.5	Φ25.2	16.0	20.0	11	27	30	33	33	4	1
AGH32-25.5	M32×1.5	Φ32.3	21.0	25.5	13	28.5	36	39.7	39.7	4	1