

RPA-4B-1F is compliant with VESA100 (100x100) mounting standards, therefore can be attached onto the back side of display monitors, among others.

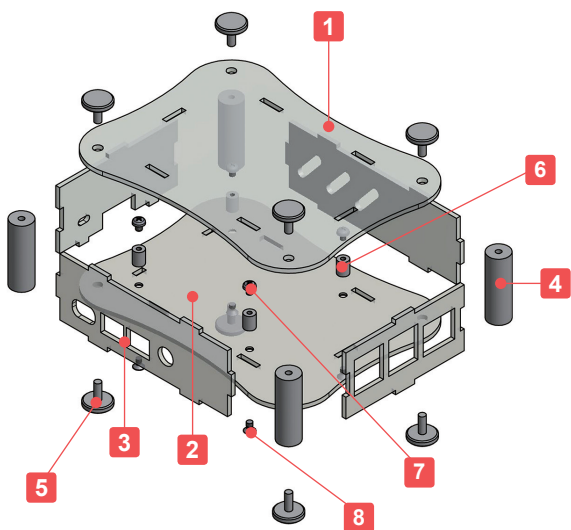

- Exclusively for use with Raspberry Pi 4B models.
- 3 models are available: Standard, Layered, and Flanged.
- Raspberry Pi Board is not included.

※Ethanol or other alcoholic solvents may cause the acrylic panel to crack.
Use a neutral cleaner or specialized acrylic cleaning solvent for cleaning.

※Included screws : RPA-4B-1 Knurled thumb screw x 8
RPA-4B-2 Knurled thumb screw x 8
RPA-4B-1F Knurled thumb screw x 4
M3-8 countersunk, Trivalent chromate x 4

Components

No.	Part name	Pcs	Material	Color / Finish
1	Top cover	1	Acrylic t = 2.0	Transparent
2	Bottom cover	1	Acrylic t = 2.0	Transparent
3	Panel	4	Acrylic t = 2.0	Transparent
4	Pillar	4	Extruded aluminium A6063S-T5	Silver anodized
5	Knurled thumb screw (M3-8)※	4 / 8	Brass	Nickel plated
6	Standoff (for board)	4	Brass	Nickel plated
7	Screw for Board (M2.6-4)	4	Steel	Trivalent chromate
8	Screw for Standoffs (M2.6-5)	4	Steel	Trivalent chromate

RPA dimensions

■ Drawings below are reference examples only.
DXF/DWG/PDF drawings available on our website.

RPA-4B-1

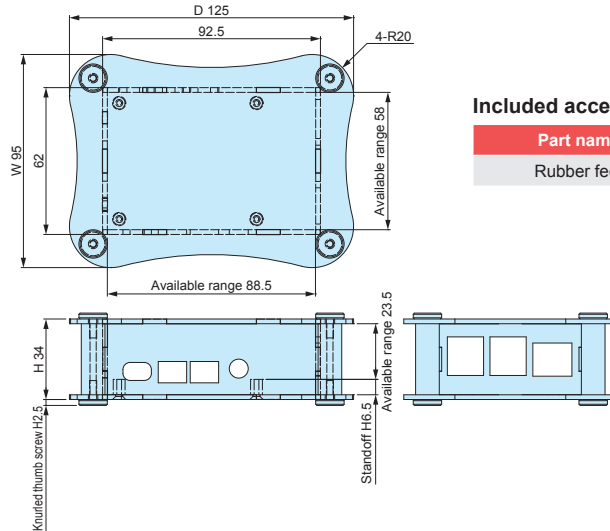

Included accessories

Part name	Material	Color / Finish
Rubber feet	Polyurethane	Transparent

RPA-4B-2

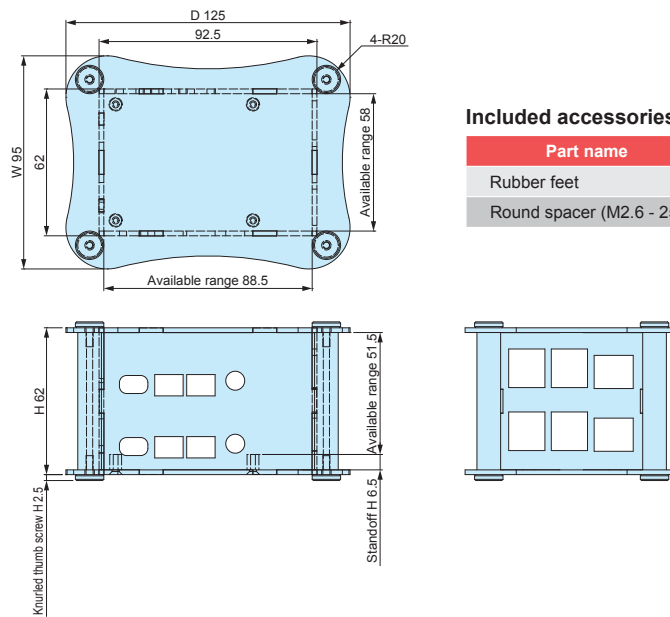

Included accessories

Part name	Material	Color / Finish
Rubber feet	Polyurethane	Transparent
Round spacer (M2.6 - 25)	Brass	Nickel plated

RPA-4B-1F

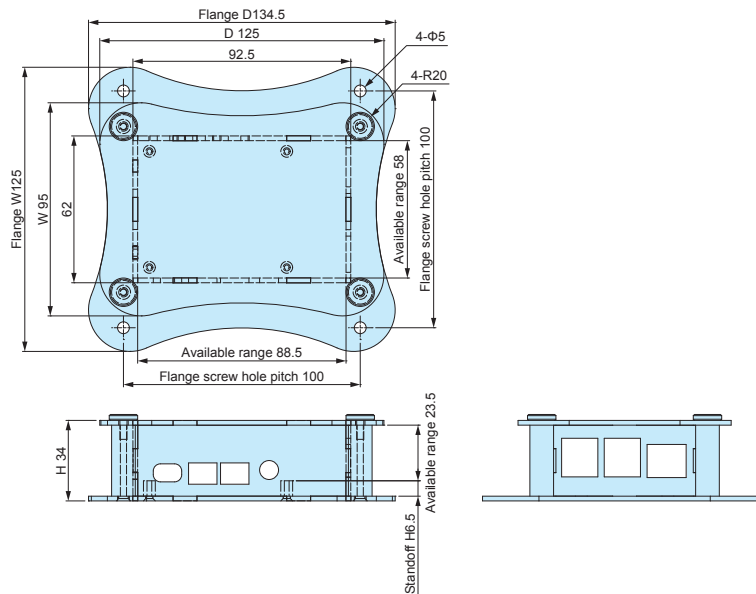

Product no. / Dimensions

Product no.	External dimensions			Weight (g)
	W	H	D	
RPA-4B-1	95	34	125	118
RPA-4B-2	95	62	125	171.5
RPA-4B-1F	95	34	125	118.5

Show inside for visual appeal with our transparent case.

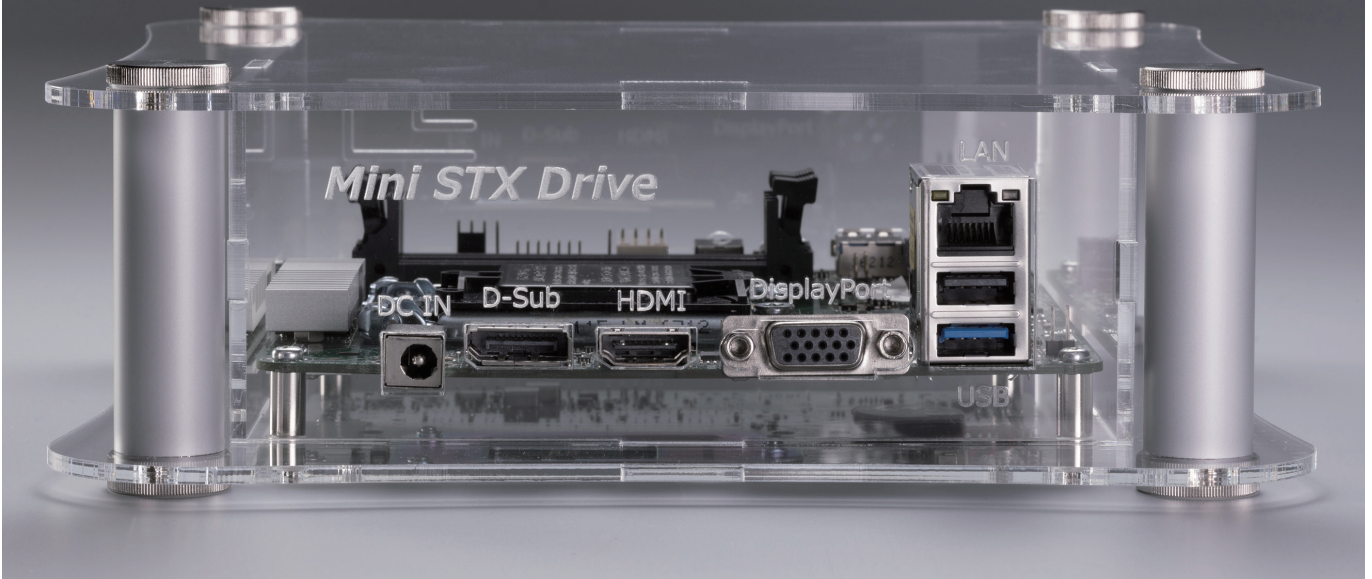

EMBEDDED COMPUTER

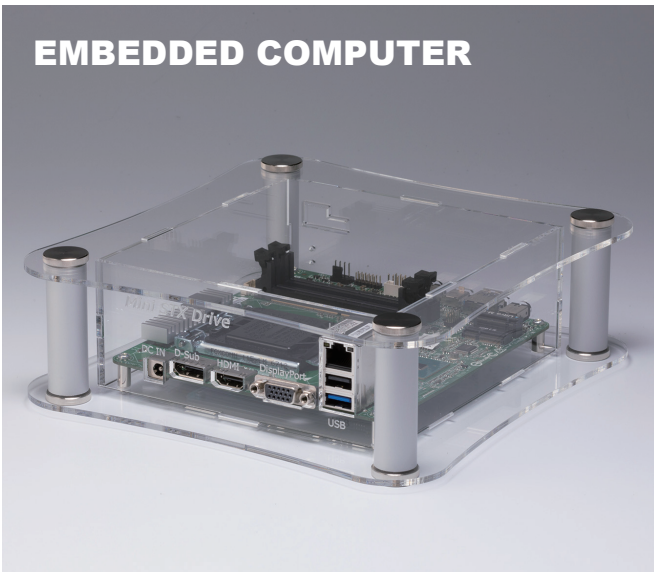

RASPBERRY PI CASE

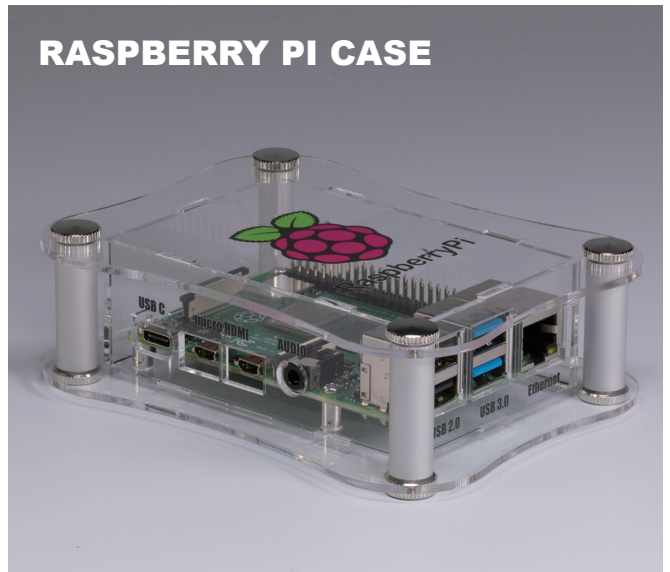

DISPLAY CASE



THERMOSTAT

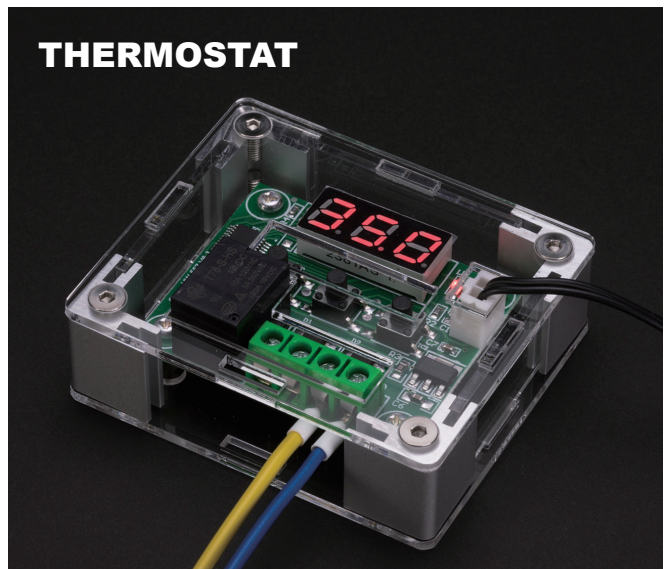

CUSTOMIZATION POSSIBILITIES

Inkjet Printing • Engraving

Print your logo, letters via inkjet printing with low initial cost from just 1 piece.
Engraving is also possible!



Developed Idea by using acrylic panels

Aluminium panels can be exchanged for an acrylic panel for display of internal components. Perfect for use as showcase models or product demonstrations. (Example: FC series)

Used as a visually appealing decorative front panel placing on a standard aluminium panel. (Example: AWA series)



COLOR VARIATION

Available in different color types, as well as smoked / tinted shades.

