

PF SERIES FLAT NETWORK CASE

Huge selection, 36 different sizes are now available.

Suitable for IOT device, Data transmitter and receiver, access point.

From 100 x 67 x 22.5 to 320 x 225 x 100mm.

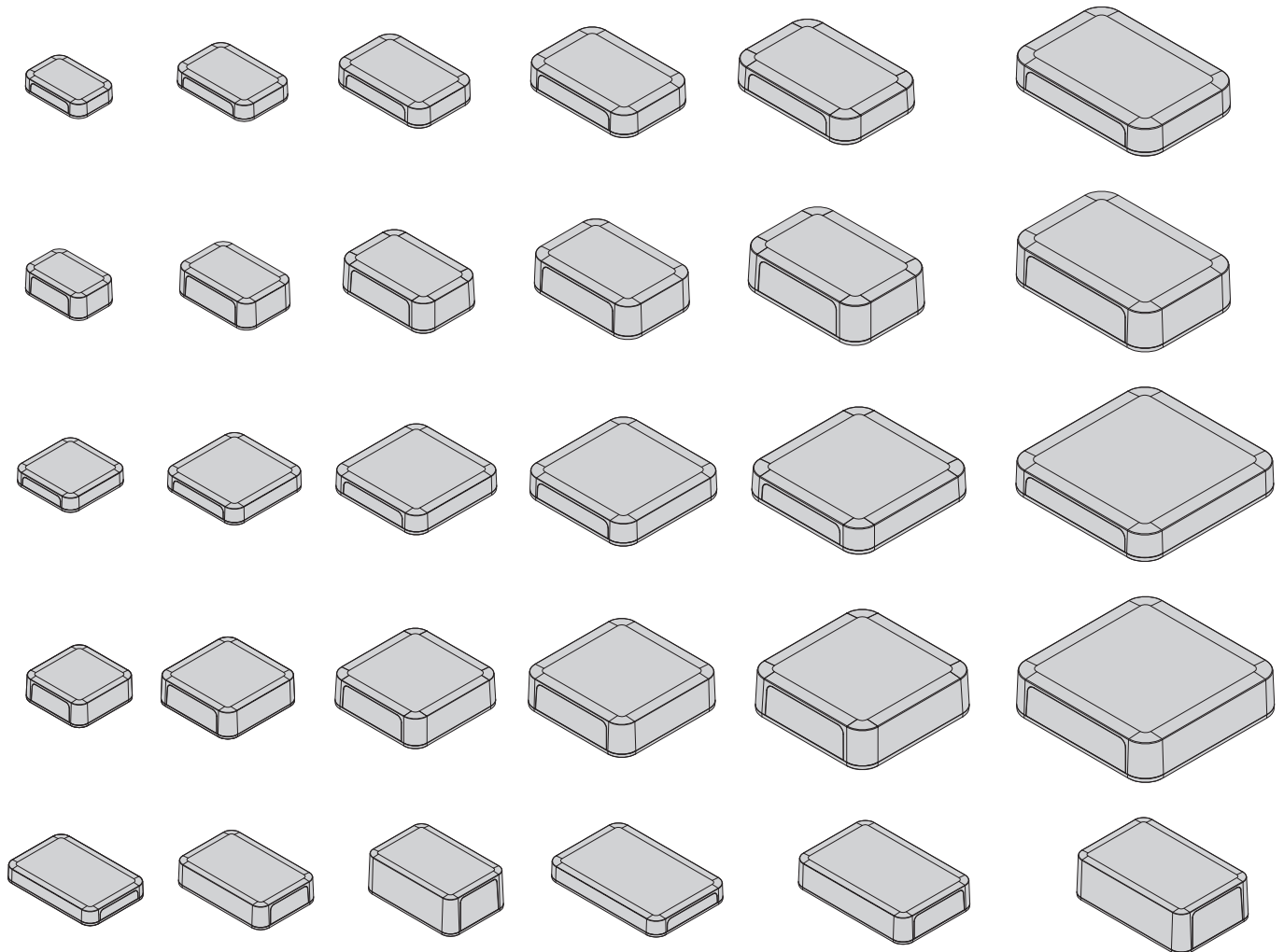

New sizes

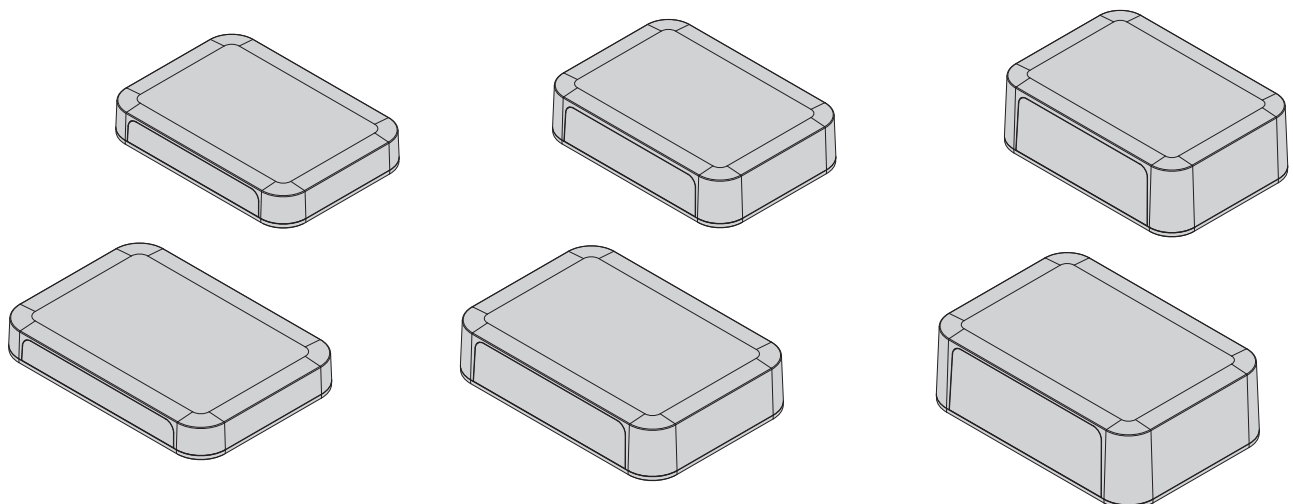

APPLICATION EXAMPLE

WiFi Access Point

Product by VNPT Technology (Vietnam)

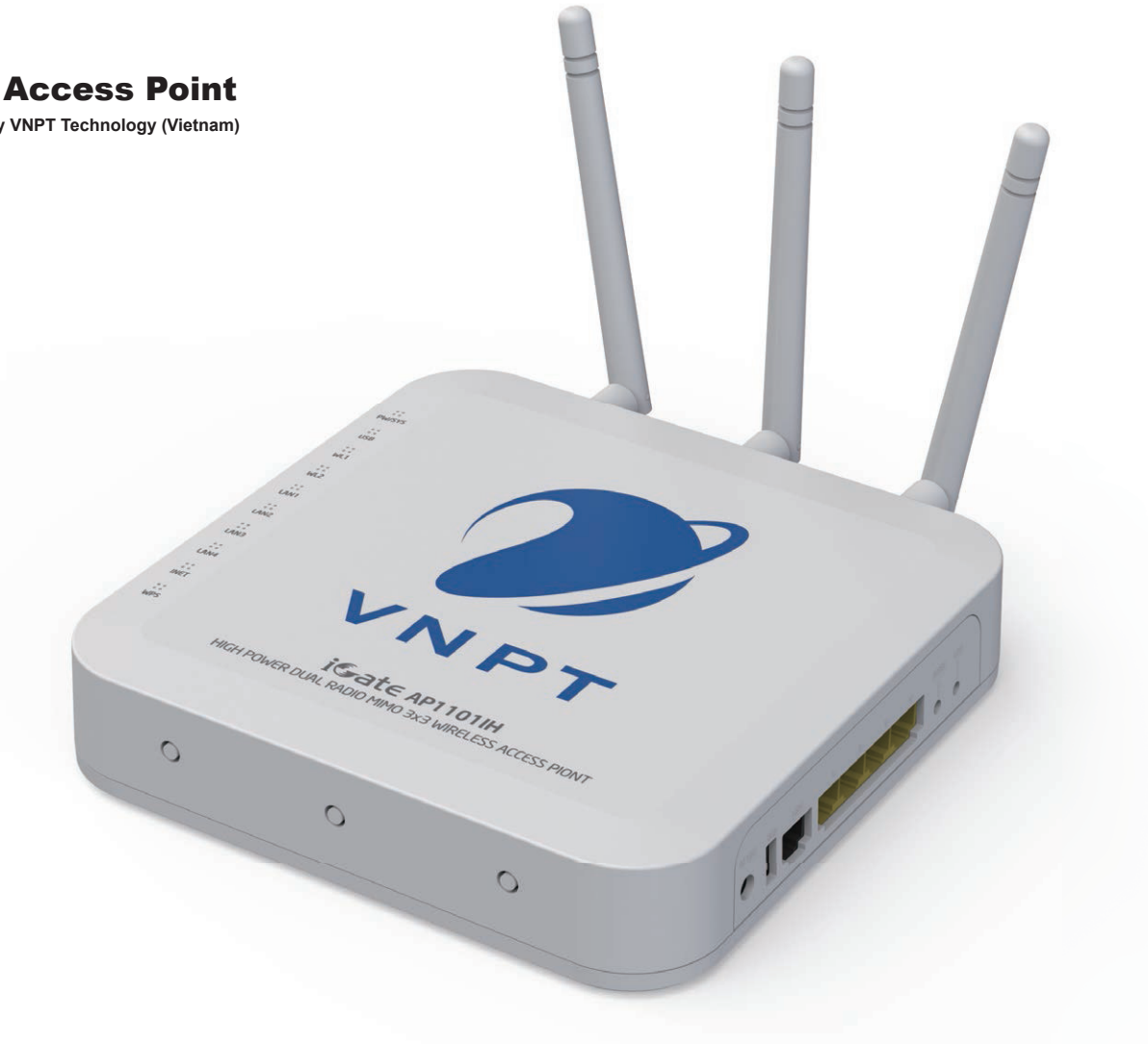

USB Power Charging Hub + Data Hub

Product by MtT-planning (Japan)



Possible to power charging while transferring data.

USB HEMODYNAMIC RESEARCH DEVICE

Product by Cardiovascular Engineering (USA)

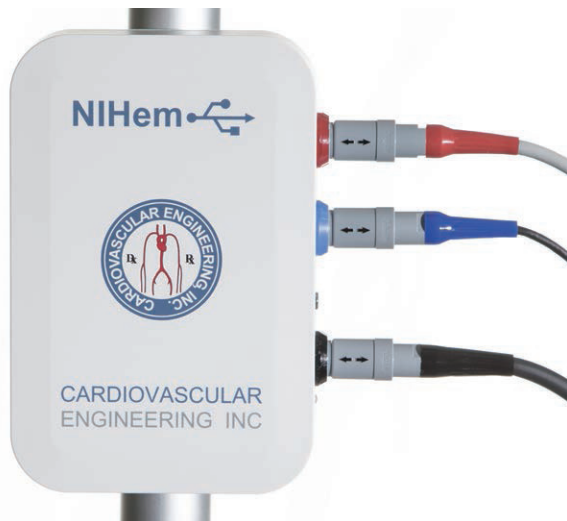

WIRELESS HOME ELECTRONICS CONTROLLER

Product by AR SMART (Colombia)



GSM MODULE

Product by Elmar Electronic (Croatia)



ADVANCED TRIGGER STATION

Product by BrainTrends (Italy)



G4 FLIGHT TRACKER

Product by Guardian Mobility (Canada)



iCONSE-T IOT and SENSOR NETWORK TRAINING SYSTEM

Product by Benchmark Electronic Systems (India)



"SenSu" COMMUNICATION UNIT with SENSOR

Product by DATA TECHNOLOGY (Japan)

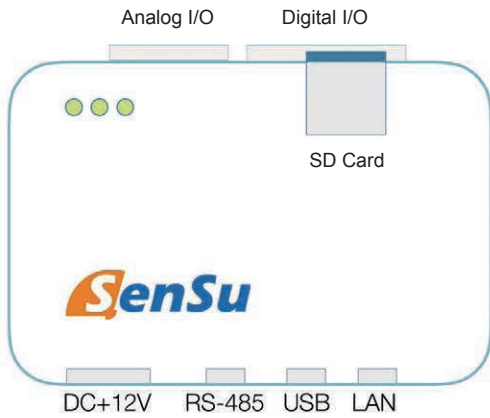
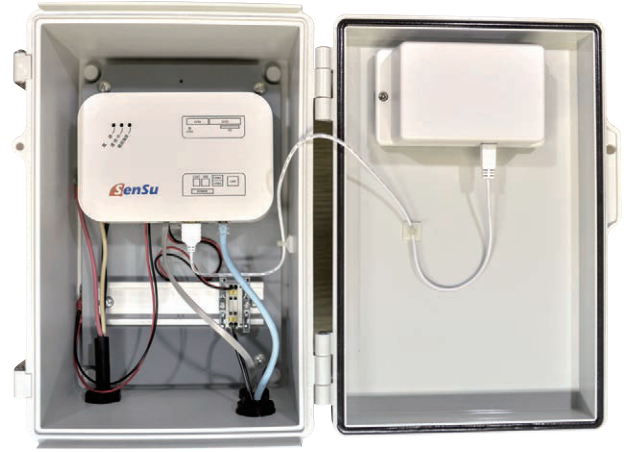

Application Example for Agriculture
Outdoor application with BCPC series Polycarbonate box.

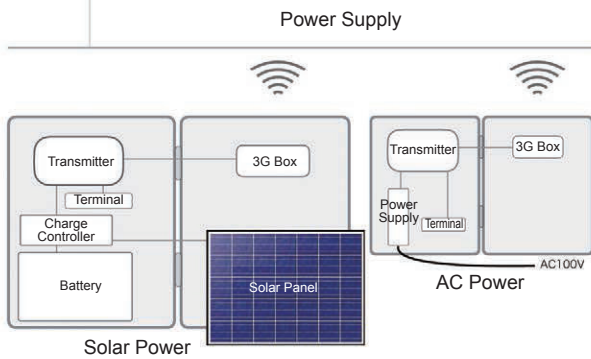

Exclusive Interface

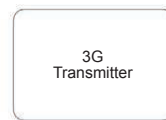

USB



LAN

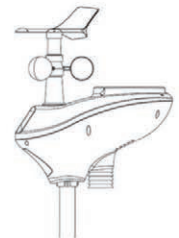

RS-485

WIRELESS NETWORK DATA LOGGER

Product by SensingWinTech (Japan)





Technical Data

Protection class: IP40
 Operating temperature: -10°C ~ +60°C

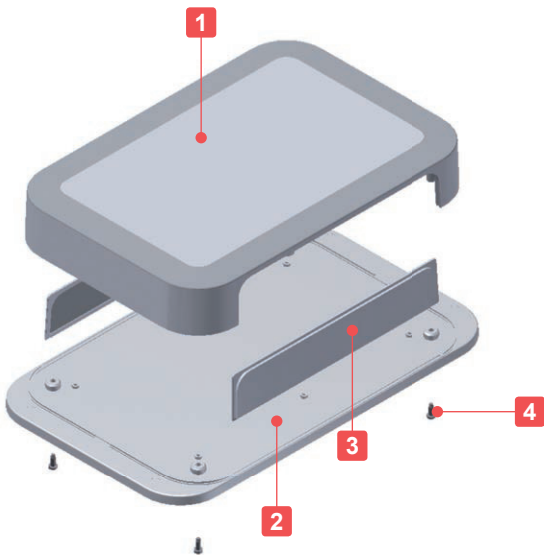

- PF plastic case with wall mounting flange bottom design.
- Made of flame-resistant ABS UL94V-0 and available in off-white color.
- 6 new sizes added for a total of 30 different sizes available for selection.
- Equipped with built-in bosses for PCB mounting.
- Suitable for Wi-Fi access point, wireless LAN, HUB, controller or other applications.

Components

No.	Part name	Pcs	Material	Color / Finish
1	Top cover	1	ABS UL94V-0	Off-white
2	Flanged base	1	ABS UL94V-0	Off-white
3	Panel	2	ABS UL94V-0	Off-white
4	Self-tapping screw	4	Steel	Nickel plated

Accessories (Optional parts)



Tapping standoff TPS series
See page TPS · MT-1



PCB mounting screw EM series
See page EM · MR-1

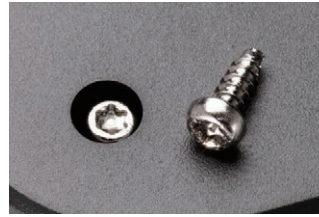

TORX screw MR series
See page EM · MR-1

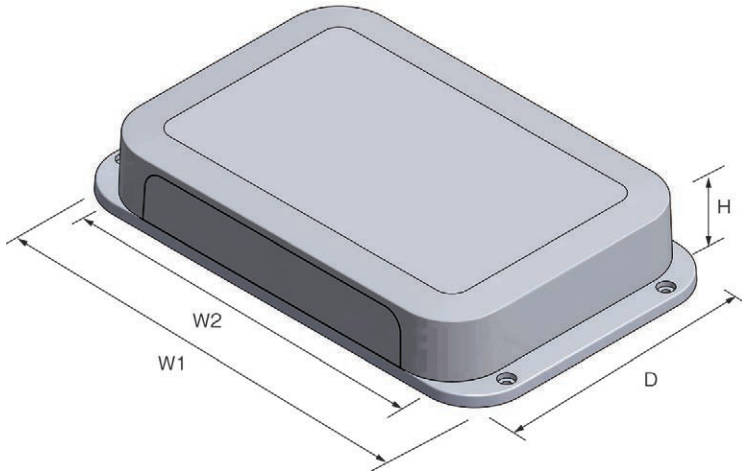

Product no. / Dimensions

Product no.	Dimensions				Screw	Weight (g)	
	● Off-white	W1	W2	H			D
PFF10- 2- 7W		124.3	100	22.5	67.3	M2.5-8 x 4 pcs	60.8
PFF10- 2-10W		124.3	100	22.5	100.3	M2.5-8 x 4 pcs	84.6
PFF10- 4- 7W		124.3	100	35	67.3	M2.5-8 x 4 pcs	72
PFF10- 4-10W		124.3	100	35	100.3	M2.5-8 x 4 pcs	99.1
PFF13- 3- 9W		149.3	125	25	85.3	M2.5-8 x 4 pcs	90.8
PFF13- 3-13W		155.3	125	25	125.3	M2.5-8 x 4 pcs	128.6
PFF13- 4- 9W		149.3	125	40	85.3	M2.5-8 x 4 pcs	108.4
PFF13- 4-13W		155.3	125	40	125.3	M2.5-8 x 4 pcs	152.3
PFF15- 3-10W		180.4	150	30	100.4	M2.5-8 x 4 pcs	145.2
PFF15- 3-15W		180.4	150	30	150.4	M2.5-8 x 4 pcs	211.3
PFF15- 5-10W		180.4	150	45	100.4	M2.5-8 x 4 pcs	168.6
PFF15- 5-15W		180.4	150	45	150.4	M2.5-8 x 4 pcs	235
PFF18- 4-12W		205.4	175	35	120.4	M2.5-8 x 4 pcs	192.1
PFF18- 4-18W		205.4	175	35	175.4	M2.5-8 x 4 pcs	209.8
PFF18- 5-12W		205.4	175	50	120.4	M2.5-8 x 4 pcs	215.8
PFF18- 5-18W		205.4	175	50	175.4	M2.5-8 x 4 pcs	299.7
PFF20- 4-13W		230.5	200	40	135.5	M3-8 x 4 pcs	267.7
PFF20- 4-20W		230.5	200	40	200.5	M3-8 x 4 pcs	376
PFF20- 6-13W		230.5	200	60	135.5	M3-8 x 4 pcs	309.7
PFF20- 6-20W		230.5	200	60	200.5	M3-8 x 4 pcs	422.9
PFF24- 4-17W		270.5	240	42.5	165.5	M3-8 x 4 pcs	366.9
PFF24- 4-24W		270.5	240	42.5	240.5	M3-8 x 4 pcs	513.5
PFF24- 6-17W		270.5	240	60	165.5	M3-8 x 4 pcs	403.8
PFF24- 6-24W		270.5	240	60	240.5	M3-8 x 4 pcs	560.8
NEW PFF28- 5-20W		310.5	280	45	200.5	M3-8 x 4 pcs	547.5
NEW PFF28- 7-20W		310.5	280	65	200.5	M3-8 x 4 pcs	606.6
NEW PFF28- 9-20W		310.5	280	90	200.5	M3-8 x 4 pcs	694.1
NEW PFF32- 5-23W		350.5	320	45	225.5	M3-8 x 4 pcs	679.9
NEW PFF32- 7-23W		350.5	320	70	225.5	M3-8 x 4 pcs	767.4
NEW PFF32-10-23W		350.5	320	100	225.5	M3-8 x 4 pcs	887.4

PFF dimensions

■ Drawings below are reference examples only.
DXF/DWG/PDF drawings available on our website.

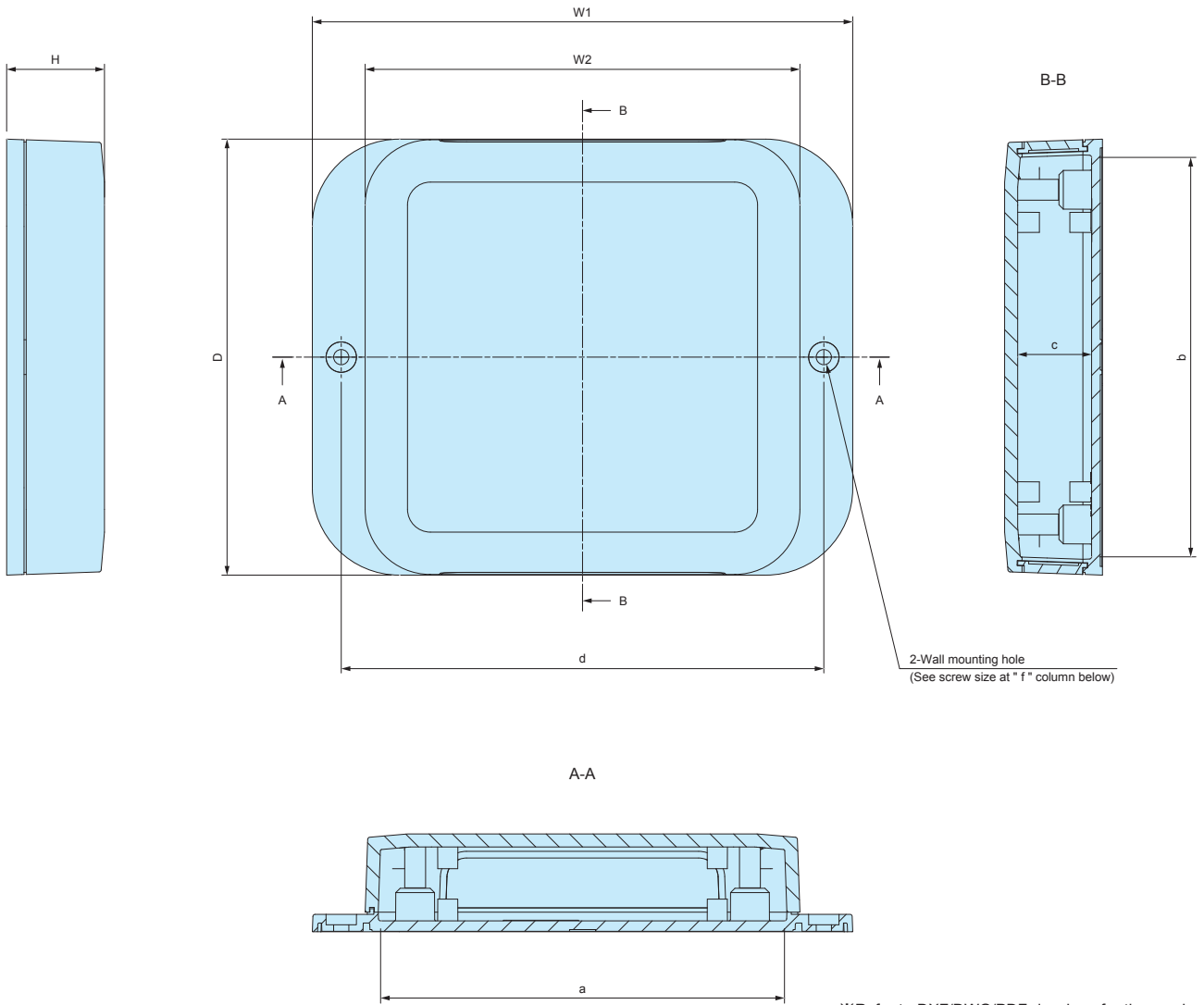

※Refer to DXF/DWG/PDF drawings for the numbers of PCB bosses on each size of enclosures.

Product no.	W1	W2	H	D	a	b	c	d	f
PFF10-2- 7W	124.3	100	22.5	67.3	92	58	17	111	M3
PFF10-2-10W	124.3	100	22.5	100.3	92	91	17	111	M3
PFF10-4- 7W	124.3	100	35	67.3	91	57	29.5	111	M3
PFF10-4-10W	124.3	100	35	100.3	91	90	29.5	111	M3
PFF13-3- 9W	149.3	125	25	85.3	117	76	19.5	136	M3
PFF13-3-13W	155.3	125	25	125.3	117	116	19.5	138.9	M4
PFF13-4- 9W	149.3	125	40	85.3	116	75	34.5	136	M3
PFF13-4-13W	155.3	125	40	125.3	116	115	34.5	138.9	M4
PFF15-3-10W	180.4	150	30	100.4	142	90	24	164	M4
PFF15-3-15W	180.4	150	30	150.4	142	140	24	164	M4
PFF15-5-10W	180.4	150	45	100.4	141	89	39	164	M4
PFF15-5-15W	180.4	150	45	150.4	141	139	39	164	M4
PFF18-4-12W	205.4	175	35	120.4	166	110	29	189	M4
PFF18-5-12W	205.4	175	50	120.4	165	109	44	189	M4
PFF20-4-13W	230.5	200	40	135.5	191.5	124.5	34	214	M4
PFF20-6-13W	230.5	200	60	135.5	190	123	54	214	M4

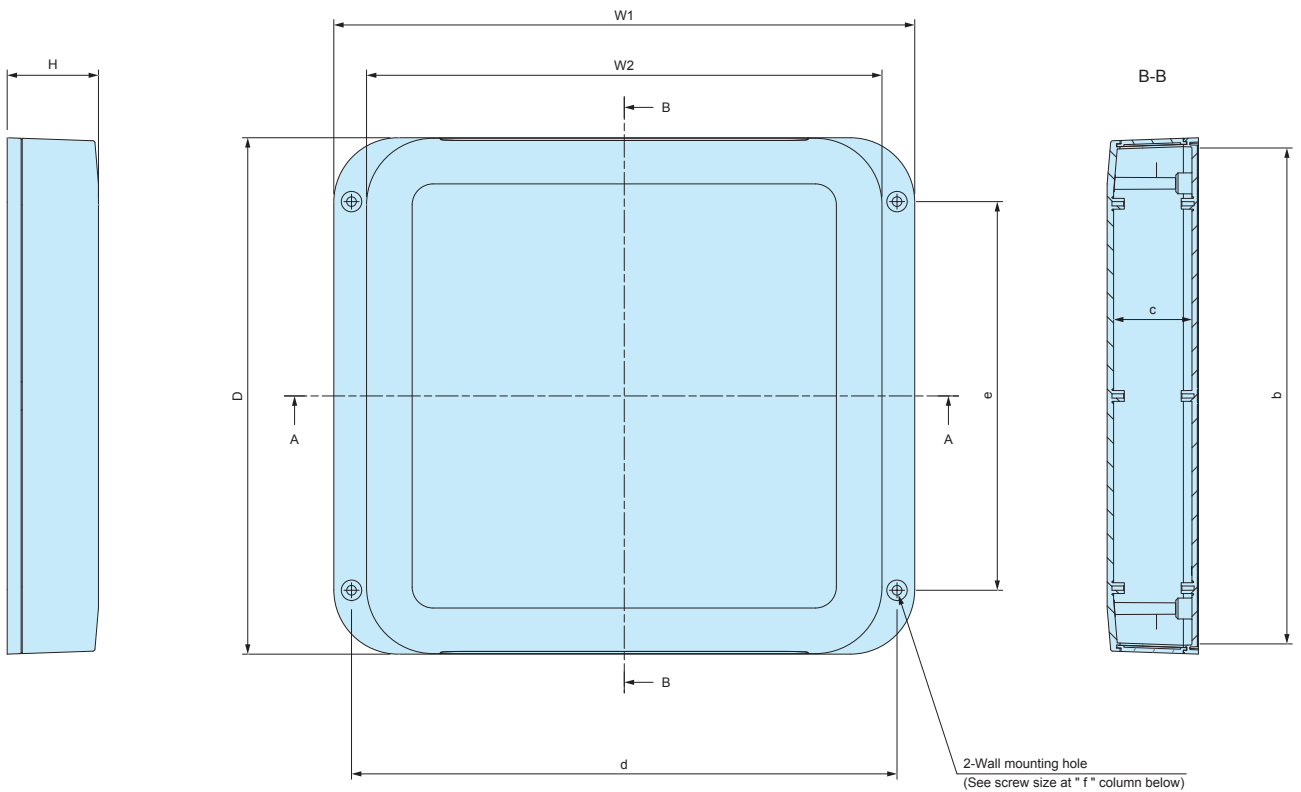

A-A

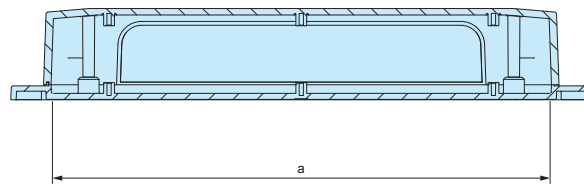

※Refer to DXF/DWG/PDF drawings for the numbers of PCB bosses on each size of enclosures.

Product no.	W1	W2	H	D	a	b	c	d	e	f
PFF18- 4-18W	205.4	175	35	175.4	166	165	29	189	130	M4
PFF18- 5-18W	205.4	175	50	175.4	165	164	44	189	130	M4
PFF20- 4-20W	230.5	200	40	200.5	191.5	189.5	34	214	145	M4
PFF20- 6-20W	230.5	200	60	200.5	190	188	54	214	145	M4
PFF24- 4-17W	270.5	240	42.5	165.5	230	154	36.5	254	106	M4
PFF24- 6-17W	270.5	240	60	165.5	229	153	54	254	106	M4
PFF24- 4-24W	270.5	240	42.5	240.5	230	229	36.5	254	181	M4
PFF24- 6-24W	270.5	240	60	240.5	229	228	54	254	181	M4
PFF28- 5-20W	310.5	280	45	200.5	269.5	189	38.5	293.5	137	M4
PFF28- 7-20W	310.5	280	65	200.5	268.5	187.5	58.5	293.5	137	M4
PFF28- 9-20W	310.5	280	90	200.5	266.5	185.5	83.5	293.5	137	M4
PFF32- 5-23W	350.5	320	45	225.5	309.5	214	38.5	333.5	152	M4
PFF32- 7-23W	350.5	320	70	225.5	308	212	63.5	333.5	152	M4
PFF32-10-23W	350.5	320	100	225.5	306	210	93.5	333.5	152	M4

TPS SERIES

TAPPING STANDOFF



- Tapping screw head allows for easy installation onto existing enclosure boss mount.
- 3 different sizes available : M2.3, M2.6 and M3 size.

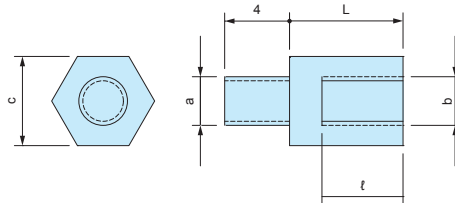

Product no. / Dimensions

■ Material / Finish : Brass / Unfinished

Product no.	Screw size (a)	Screw size (b)	c	L	ℓ	Pack of	Recommended enclosure models	
TPS-M2.3-4	M2.3	M2.3	5	4	3	4	WH series • PFE series LC • LCE • LCS • LCT series PF • PFF series (M2.3 boss models) TW • TWN • TWF series (M2.3 boss models) WP series (M2.3 boss models)	
TPS-M2.3-5	M2.3	M2.3	5	5	3	4		
TPS-M2.3-6	M2.3	M2.3	5	6	4	4		
TPS-M2.3-7	M2.3	M2.3	5	7	5	4		
TPS-M2.3-8	M2.3	M2.3	5	8	6	4		
TPS-M2.3-10	M2.3	M2.3	5	10	6	4		
TPS-M2.3-12	M2.3	M2.3	5	12	6	4		
TPS-M2.6-4	M2.6	M2.6	5	4	3	4		PF • PFF series (M2.6 boss models) WP series (M2.6 boss models)
TPS-M2.6-5	M2.6	M2.6	5	5	3	4		
TPS-M2.6-7	M2.6	M2.6	5	7	5	4		
TPS-M2.6-10	M2.6	M2.6	5	10	6	4		
TPS-M2.6-12	M2.6	M2.6	5	12	6	4	SU • OP series TWS • TW • TWN • TWF series (M3 boss models)	
TPS-M3-4	M3	M3	5.5	4	3	4		
TPS-M3-5	M3	M3	5.5	5	3	4		
TPS-M3-6	M3	M3	5.5	6	4	4		
TPS-M3-7	M3	M3	5.5	7	5	4		
TPS-M3-8	M3	M3	5.5	8	5	4		
TPS-M3-10	M3	M3	5.5	10	6	4		
TPS-M3-12	M3	M3	5.5	12	6	4		



- Please use a suitable sized socket driver to both secure and loosen the tapping standoff.



MT SERIES

PCB MOUNTING SCREWS for TPS



- PCB mounting Screws for TPS tapping standoffs.

Product no. / Dimensions

Product no.	M	L	Head style	Material	Finish	Pack of
NEW MT2.3-4	2.3	4	Pan	Steel	Trivalent chromate	20
NEW MT2.3-6	2.3	6		Steel	Trivalent chromate	20
NEW MT2.6-4	2.6	4		Steel	Trivalent chromate	20
MT3-4	3	4		Steel	Trivalent chromate	20

EM SERIES

PCB MOUNTING SCREW

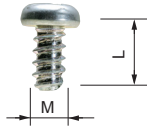

- Self-tapping screws for mounting PCB on bosses or standoffs.
- EM-3-6 self-tapping screws are suitable for mounting 1.6mm or thicker PCB.

Product no. / Dimensions

Product no.	M	L	Material	Finish	Suitable enclosures	Pack of
EM-1.6	1.6	4	Steel	Trivalent chromate	WC • CSS • CS • PS (M1.6 size)	50
EM-2	2	5	Steel	Trivalent chromate	PS • TW • TWN • TWF • WP (M2 size)	50
EM-2.3	2.3	6	Steel	Trivalent chromate	WH • LC • LCT • LCS • LCE • PFE WSC (Top cover bosses) PF • PFF (M2.3 size) TW • TWN • TWF (M2.3 size) WP (M2.3 size)	50
NEW EM-2.3-8	2.3	8	Steel	Trivalent chromate	WSC (Bottom base bosses)	50
EM-2.6	2.6	6	Steel	Trivalent chromate	PF • PFF • WP (M2.6 size)	50
EM-3	3	5	Steel	Trivalent chromate	SU TWS • TW • TWN • TWF (M3 sizes)	50
EM-3-6	3	6	Steel	Trivalent chromate		50

MR SERIES

TORX SCREW



Countersunk head

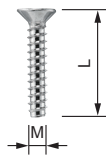

Pan head

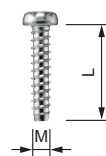

With pin

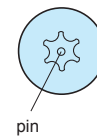

★ Without pin

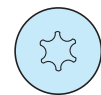

★ : MR1.6-6S, MR-2S, MR2.6-10□, and MR3-14□ are without pin.

Product no. / Dimensions

★Mark = Without pin

Product no.	M	L	head no.	Head style	Material	Finish	Suitable enclosures	Pack of
MR1.6-6S★	1.6	6	T3	Pan	Steel	Nickel plated	CS • CSS	20
MR2.5-8PS	2.5	8	T8	Pan	Steel	Nickel plated	PF • PFE • PFF (M2.5 size)	20
MR2.6-10S★	2.6	10	T8	Countersunk	Steel	Nickel plated	TW • TWN (M2.6 models) TWF (M2.6 models)	20
MR2.6-10B★	2.6	10	T8	Countersunk	Steel	Black trivalent chromate	MX • MXA • MXB • MXF (M2.6 models)	20
MR2.6-12PS	2.6	12	T8	Pan	Steel	Nickel plated	LCT • LCS • LC115-F2 / F3 LCT • LCS • LC145S-F6	20
MR2.6-14PS	2.6	14	T8	Pan	Steel	Nickel plated	LCT • LCS • LC115H-F2 / F3 / M2 / 9V LCT • LCS • LC135-F4 / M2 / M3 / 9V LCT • LCS • LC135H-F4 / M2 / M3 / 9V LCT • LCS • LC145-F6 / M2 / M4 LCT • LCS • LC145H-F6 / M2 / M4 LCT • LCS • LC165-M4 LCT • LCS • LC165H-M4	20
MR2.6-14S	2.6	14	T8	Countersunk	Steel	Nickel plated	LCT • LCS • LC115-N / F2 / F3 LCT • LCS • LC145S-F6 / 145S-N LCE115-N TW • TWN7-2-11 / 7-4-11 / 7-5-11 TWF7-2-11 / 7-4-11 / 7-5-11 / 8-2-8 / 8-4-8	20
MR2.6-18S	2.6	18	T8	Countersunk	Steel	Nickel plated	LCT • LCS • LC115H-N / F2 / F3 / M2 / 9V LCT • LCS • LC135-N / F4 / M2 / M3 / 9V LCT • LCS • LC135H-N / F4 / M2 / M3 / 9V LCT • LCS • LC145-N / F6 / M2 / M4 LCT • LCS • LC145H-N / F6 / M2 / M4 LCT • LCS • LC165-N / M4 LCT • LCS • LC165H-N / M4 LCE115H-N • LCE135-N • LCE145H-N • LCE165H-N	20
MR3-8PS	3	8	T10	Pan	Steel	Nickel plated	PF • PFE • PFF (M3 size)	20
MR3-14S★	3	14	T10	Countersunk	Steel	Nickel plated	TW • TWN (M3 models)	20
MR3-14B★	3	14	T10	Countersunk	Steel	Black trivalent chromate	TWF (M3 models) MX • MXA • MXB • MXF (M3 models)	20
MR-1S	3	5	T10	Countersunk	Steel	Nickel plated	UC	20
MR-1B	3	5	T10	Countersunk	Steel	Black trivalent chromate	UC • UCY • US	20
MR-2S	3	10	T10	Countersunk	Steel	Nickel plated	HEN	20