

NANUK™

PROFESSIONAL PROTECTIVE CASES

THE FUTURE OF PROTECTION CASES

Tough yet stylish.
Durable and elegant.
Easily customizable.
Endless possibilities abound.



OUTDOOR

NANUK-1



MEASUREMENT



DRONE



MEDICAL

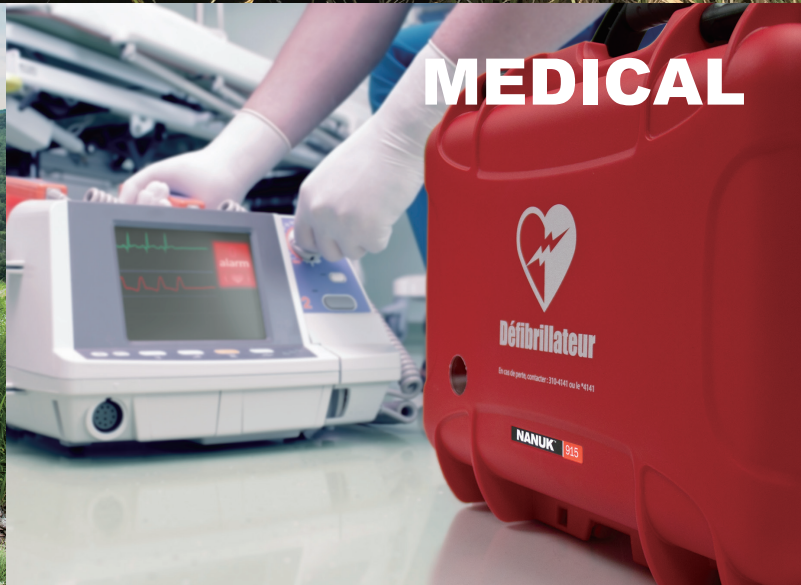

TRANSPORT



DEFENCE



NANUK™ THE NANUK ADVANTAGE

IP65 PROTECTION CLASS

IP65 protection class for use in various environments.

Equipped with durable and weather resistant EPDM gasket.

Waterproof pressure relief valve enables pressure within the case to be equalized with the surrounding, allowing it to be opened with ease, while keeping it waterproof.



IMPACT RESISTANT-NK-7 RESIN

Impact resistant, lightweight, and armed with reinforced PP, NK-7 resin body.

Keep your items safe from impact damage.



22 DIFFERENT SIZES

A large selection of 22 different sizes, ranging from small (148.5 x 109.5 x 43mm) to large (1,196 x 440 x 168mm) types.

Smallest 3 sizes are available in 5 different colors: black, white, clear, lime and marine colors.

Other sizes are available in either black or yellow.



PROTECTIVE SPONGE FOAM

Nanuk cases are also available with a protective sponge foam.

Sponge foam are fitted to the case, and can also be purchased as separate option (NKSP series).

NKSP sponge foam comes with pre-cubed foam to allow for easy modification by removing the required squares.

(※No pre-cubed foam available for NKSP990).

Sponge customization is also available.

(See page SP-Custom-1~SP-Custom-2)



POWERCLAW LATCHING SYSTEM and SOFT GRIP HANDLE

NANUK's patented PowerClaw latching system uses compressive force to keep your case tightly clamped.

Integrated slide lock offers added security, preventing it from accidental opening during transport or when dropped.

NANUK's TPE soft grip handle makes carrying not only comfortable, but also convenient.

Handle can be folded down to be flushed with the case when not in use.



※Latch with TSA lock on NKK series



100% STAINLESS STEEL PARTS

Metallic parts are made from SUS304 stainless steel.

Suitable to be used in environments with water splashes and so on.



OPTIONAL ALUMINIUM PANEL for YOUR DEVICE

Optional aluminium panel can make NANUK into your original controller, measuring device or transmitter.

See page NKAP-1 for the details of optional aluminium panel.

NKAP panel customization is available. (See NKAP-2 for more details).

●CUSTOMIZATAION on ALUMINIUM PANEL

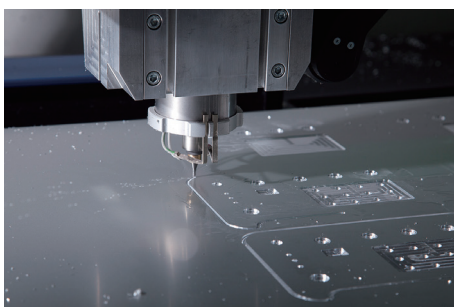

CUSTOMIZE



NANO SERIES

WATERPROOF PORTABLE CASE



- IP65 waterproof compact and stylish case.
- Slit holes on both sides for strap or belt.
- Suitable for storing small electric devices such as mobile phones, wireless devices, portable radios, and so on.



Technical Data
Protection class : IP65
Operating temperature : -20°C~+60°C

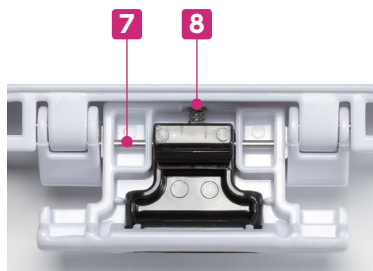

Latch (lock mechanism) side



Hinge Side

● How To Use Strap



Insertion of clip into the case



Use as handy strap



Insert strap end into the loop after clip insertion.



Fix it to the belt loop, etc.

Components

No.	Part name	Material
1	Cover · Base	Polycarbonate
2	Protective net	Silicone
3	Lock lever	Polycarbonate
4	Corner guard	Elastomer
5	Gasket	Elastomer
6	Strap	Nylon · Nylon 66
7	Latch pin	Stainless steel
8	Spring	Stainless steel
9	Pressure relief valve (※)	Nylon 66 · PTFE

※ Waterproof pressure relief valve enables pressure within the case to be equalized with the surrounding, allowing it to be opened with ease, while keeping it waterproof.

NANO dimensions

■ Drawings below are reference examples only.
DXF/DWG/PDF drawings available on our website.

NANO 310

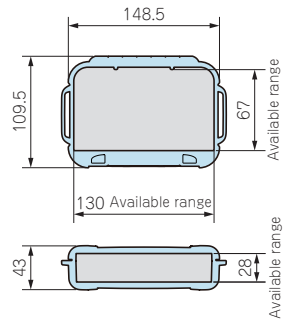

NANO 320

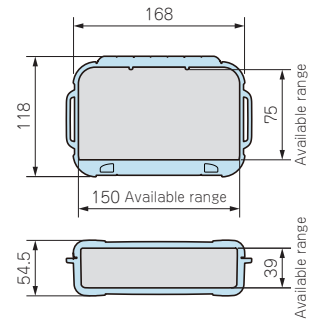

NANO 330

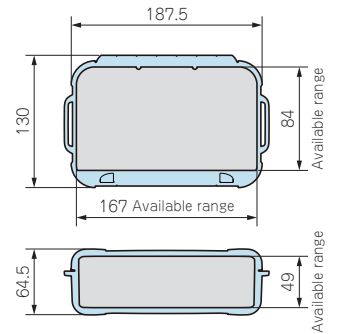

Product no. / Dimensions

Product no.					Dimensions (External)			Dimensions (Internal)			Weight (g)
● Black	● White	● Clear	● Lime	● Marine	W	D	H	w	d	h	
NANO310B	NANO310W	NANO310C	NANO310L	NANO310M	148.5	109.5	43	130	67	28	265
NANO320B	NANO320W	NANO320C	NANO320L	NANO320M	168	118	54.5	150	75	39	350
NANO330B	NANO330W	NANO330C	NANO330L	NANO330M	187.5	130	64.5	167	84	49	450

Applicable for use as electronic and communication devices

PCB can be installed with PCB mounting screw MT series.
NANO series can also be used as a pole mounted communication device.



Accessories(Optional parts)



Aluminium panel NKAP series
See page NKAP-1~NKAP-2



PCB mounting screw MT series
See page NKAP-1



Nameplate sticker NKST series
See page NANUK-ACC-3



NKAP SERIES

ALUMINIUM PANEL for NANO · NK · NKK

↔ NEW SIZE



Optional aluminium panel can be used as a controller control / display, measuring device, transmitter, and so on.

Drawings below are reference examples only. DXF/DWG/PDF drawings available on our website.

NKAP dimensions

NANO series

Slide insert and screw fastening

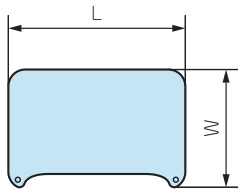

NK · NKK series

Required screws vary based on size

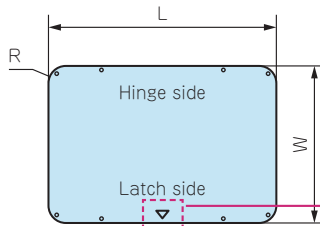

※Install panel with ▽marking towards the latch.

Components

No.	Part name	Material
1	Panel	Aluminium (Anodized)
2	Screw	Stainless steel



Product no. / Dimensions

Product no.	Suitable case	Thickness	L	W	R	▽ marking	Screw pcs	Weight (g)
NKAP310	NANO310	2	136.2	90.6	13	—	2	59
NKAP320	NANO320	2	156.8	100.4	15.7	—	2	75
NKAP330	NANO330	2	175.9	112.2	17	—	2	94
NKAP903	NK903	1.5	198.5	136.5	15	—	4	109
NKAP904	NK904	1.5	226	163.5	18	—	4	149
NKAP905	NK/NKK905	1.5	257	207	21.5	—	4	214
NEW NKAP908	NK/NKK908	1.5	250.9	200.1	18	—	4	203
NEW NKAP909	NK909	1.5	304.7	190.4	18	—	4	234
NKAP910	NK910 base side	2	346	244.5	17	—	4	452
NKAP910C	NK910 cover side	1.5	339.5	238	14	—	4	329
NKAP915	NK / NKK915	2	368.5	254	28	○	8	496
NKAP918	NK / NKK918	2	397.5	268.5	27	—	8	574
NKAP920	NK / NKK920	2	399.5	285	28	○	8	606
NEW NKAP923	NK / NKK923 base side	2	446.3	309.1	28	—	8	737
NEW NKAP923C	NK / NKK923 cover side	2	438.3	301.1	23.5	—	8	704
NKAP925	NK/NKK925	2	451.5	318	28	○	8	760
NKAP930	NK/NKK930	2	476	350.5	27	○	8	880
NKAP933	NK/NKK933	2	477.5	352	27	—	8	908
NKAP935	NK/NKK935	2	535	301.5	26.5	○	8	855
NKAP940	NK/NKK940	2	526.5	374	27	○	10	1,050
NKAP945	NK/NKK945	2	576.5	450	26.5	○	10	1,395
NEW NKAP950	NK/NKK950	2	540.8	409.1	27	—	10	1,179
NEW NKAP960	NK/NKK960	2	579.7	454.2	27	—	10	1,402

MT SERIES

PCB MOUNTING SCREW for NANO

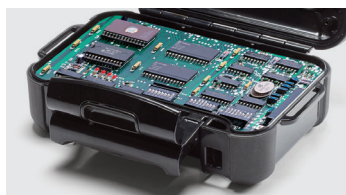
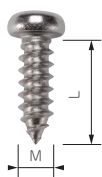

PCB should be the same size as NKAP series aluminium panel.
Insert PCB into groove (see diagram to the right) and screw into the screw marking.

Product no. / Dimensions

Product no.	M	L	Pcs
MT2.6-8T	2.6	8	2

Material : Stainless steel

CUSTOMIZATION on ALUMINIUM PANEL

- Customization services such as CNC milling, punching press, digital inkjet printing, silkscreen printing, and engraving on NKAP panel are available.
- Custom colors can also be performed either through anodization, or painting.

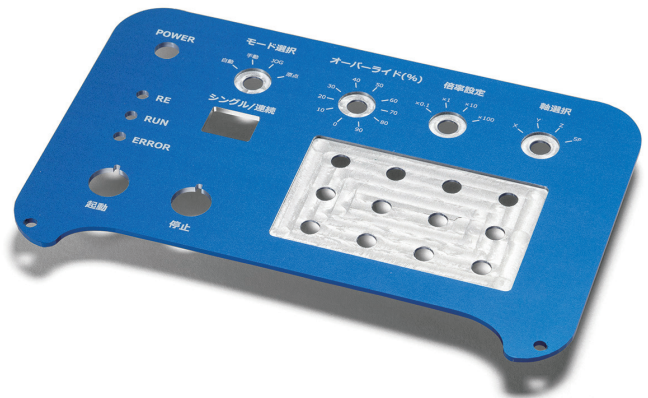
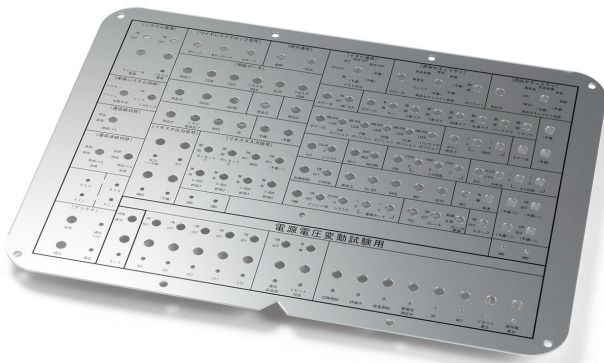
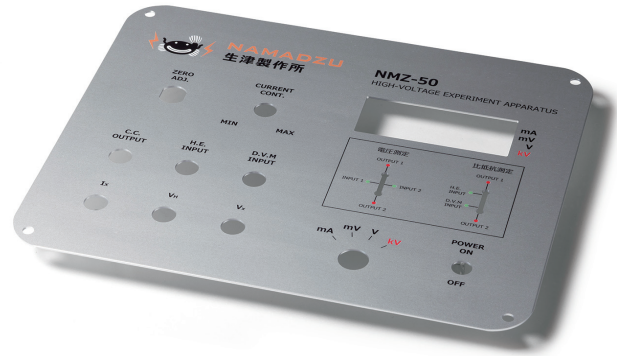

- Self-clinching Standoff/Stud/Nut or Welded Fastener customization is available.



- An original control panel with machined aluminum panel and overlay sheet can be performed.



NSTP SERIES SHOULDER STRAP

■ Nylon shoulder strap with polyurethane pads to reduce fatigue when carrying.



Components

No.	Part name	Material
1	Belt	Nylon
2	Pad	Neoprene · Polyurethane
3	Hook	Steel (Black painted)

Product no. / Feature

Product no.	Weight (g)	Quantity
NSTP810	238	1

※Belt length can be adjustable from 810mm to 1,170mm
 ※Not applicable for NK903, NK904, NKK990, NK · NKK950 and NK · NKK960 models.

AB145S SERIES PADLOCK

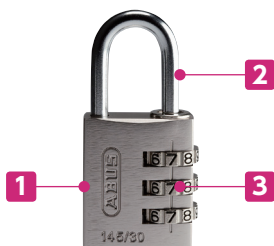

Components

No.	Part name	Material
1	Body	Aluminium
2	Shank	Steel
3	Dial	Zinc alloy

Product no. / Feature

Product no.	Weight (g)	Quantity
AB145S	52	1

NKST SERIES NAMEPLATE STICKER



Color nameplate can be performed by digital inkjet printing on a white plate.



■ 0.3mm thick plastic nameplate with double sided tape on the back.

Custom name plate can be made with your company name, logo, product number or lot number with digital inkjet printing.

■ Digital inkjet print or silkscreen is possible from just 1 piece.

Product no. / Dimensions

Product no.		Suitable case	Dimensions		Quantity
● Black	● White		A	B	
NKST-1B	NKST-1W	NANO SERIES	50	6.8	1
NKST-2B	NKST-2W	NK903, 904	62.7	9.1	1
NKST-3B	NKST-3W	NK/NKK905 ~ 960	76.1	9.1	1

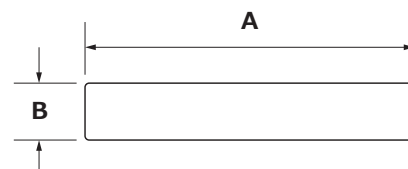

UNIQUE COLOR AVAILABLE

NANO SERIES

※See page NANO-1~NANO-2



Orange



Purple



Red

NK SERIES

※See page NK-1~NK-2



Graphite



Orange



Olive



Silver
Only available for
NK903~920
NK925~945 models



Lime
Only available for
NK903, 904, 905
908 and 910 models



Blue
Only available for
NK903 and 904
Models



Red
Only available for
NK903 and 904
Models



●For NKK series, Olive color is only available for NKK990 model.

CNC Foam Milling

Customize based on how you want it to be!

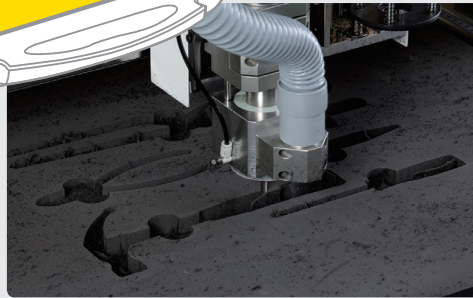
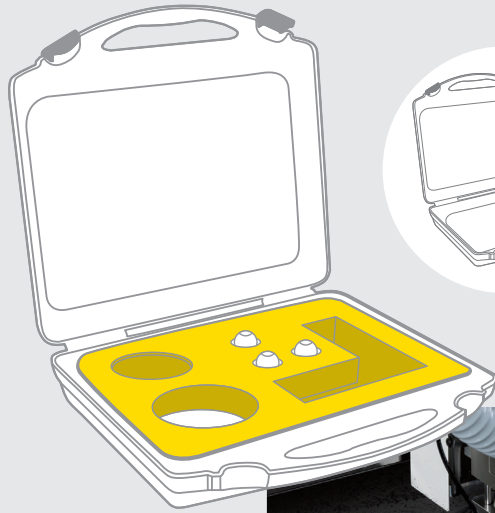

CNC foam cutting machine enables quick and cost-effective hole milling service.

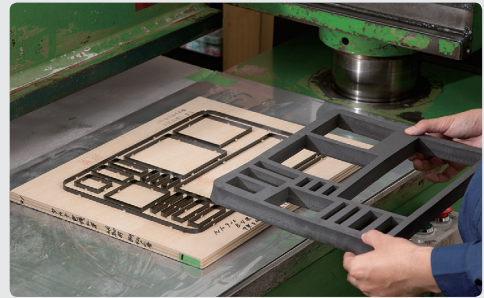

For mass production, cost-effective mold press cutting is also available.

APPLICATION EXAMPLE



CNC Machining • Printing Service for Case

CNC Machining

■ CNC machining for your switch, connector, display and so on is possible from just 1 piece.

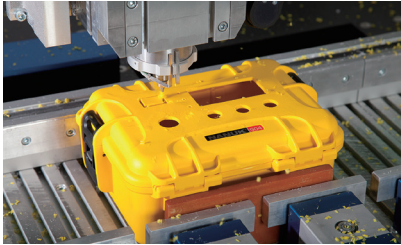

Printing Service

■ Digital inkjet printing, silkscreen printing and nameplate sticker printing is possible from just 1 piece.

Low initial cost
No plate processing fee

Inkjet printing

Low printing cost for small quantities.

● Data adjustment fees may be charged again if significant changes are required on your repeat order.

● If the data in recommended format is provided

Data adjustment fees

● Data or images other than recommended formats

Data creation fees + Data adjustment fees

Silk-screen initial tooling

Low printing cost for large quantity single color print.

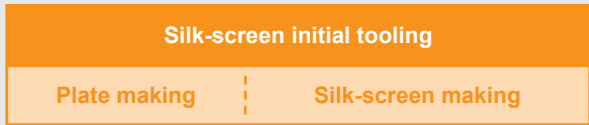

Recommended data formats

PDF (.pdf -100%)		Vector file (.ai)		EPS (.eps)	
---------------------	--	----------------------	--	---------------	--

Initial cost can be reduced with the recommended formats.



Able to Inkjet print on rigid urethane foam.

APPLICATION EXAMPLE

