

FDR SERIES

DIN-RAIL

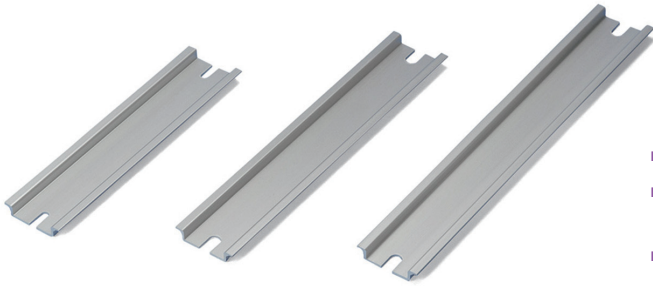

- DIN rail for installation of terminals, relays or switches inside enclosures.
- Available in different models and lengths to fit a wide variety of mounting boss pitch.
- FDR-1000 is available if customized length is required.

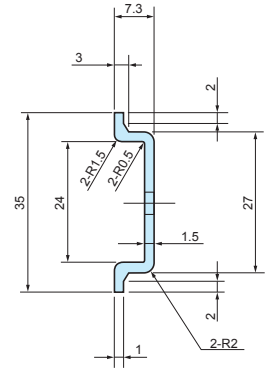
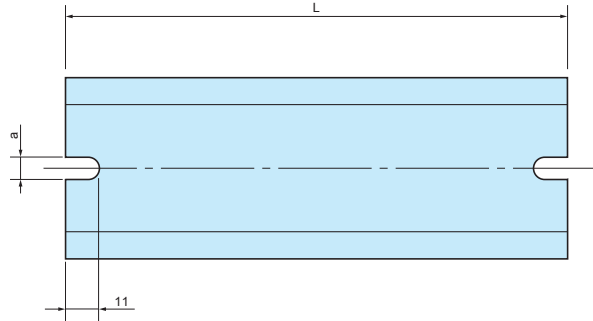
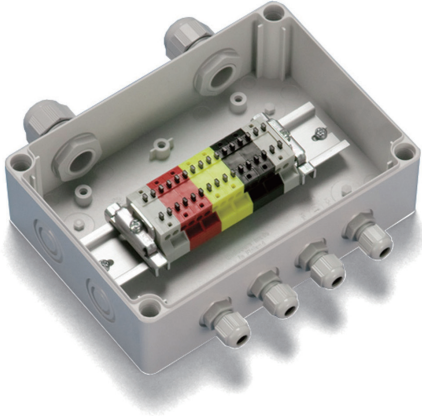

Feature

Material	Finish
Extruded Aluminium A6063S-T5	Silver anodized

Product no. / Dimensions

Product no.	L	a	Matching boss pitch
FDR- 50	50	4.2	32 ~ 42
57	57	4.2	39 ~ 49
66	66	4.2	48 ~ 58
77	77	4.2	59 ~ 69
80	80	4.2	62 ~ 72
87	87	4.2	69 ~ 79
92	92	4.2	74 ~ 84
100	100	4.2	82 ~ 92
106	106	4.2	88 ~ 98
110	110	4.2	92 ~ 102
120	120	4.2	102 ~ 112
128	128	4.2	110 ~ 120
137	137	4.2	119 ~ 129
142	142	4.2	124 ~ 134
146	146	4.2	128 ~ 138
150	150	4.2	132 ~ 142
168	168	4.2	150 ~ 160
170	170	4.2	152 ~ 162
186	186	4.2	168 ~ 178
202	202	4.2	184 ~ 194
205	205	4.2	187 ~ 197
223	223	4.2	205 ~ 215
226	226	4.2	208 ~ 218
235	235	4.2	217 ~ 227
242	242	4.2	224 ~ 234
249	249	4.2	231 ~ 241
283	283	4.2	265 ~ 275
300	300	4.2	282 ~ 292
350	350	4.2	332 ~ 342
450	450	4.2	432 ~ 442
550	550	4.2	532 ~ 542

Product no.	L	a	Matching boss pitch
FDR-B102	102	6.5	86 ~ 92
NEW B124	124	6.5	108 ~ 114
B142	142	6.5	126 ~ 132
B160	160	6.5	144 ~ 150
B165	165	6.5	149 ~ 155
B176	176	6.5	160 ~ 166
B183	183	6.5	167 ~ 173
B223	223	6.5	207 ~ 213
B260	260	6.5	244 ~ 250
B283	283	6.5	267 ~ 273
B303	303	6.5	287 ~ 293
B338	338	6.5	322 ~ 328
B360	360	6.5	344 ~ 350
B376	376	6.5	360 ~ 366
B383	383	6.5	367 ~ 373
B463	463	6.5	447 ~ 453
B560	560	6.5	544 ~ 550
B623	623	6.5	607 ~ 613
FDR-1000	1000	—	—

■ FDR-1000 does not have mounting holes.

Matching DIN-Rail Chart

BC□□ series

Product no.	Matching DIN-Rail
091207	FDR - 80
091208	80
101507	110
101508	110
112107	170
112110	170
112607	223
112610	223
BCAP	
BCPC	
BCPK	
BCAR	
BCPR	
131508	120
131808	150
131810	150
151509	120
151512	120
162110	170
162113	170
162610	223
162613	223
172211	170
172711	223

BDN series

Product no.	Matching DIN-Rail
6- 8- 5	FDR - 50
7-10- 4	-
9- 9- 6	FDR - 80
9-13- 5	120
10-14- 7	128
11-16- 6	150
12-22- 8	205
16-26- 9	242

BCAS series

Product no.	Matching DIN-Rail
071005	FDR - 92
080806	66
081104	92
081107	92
081108	92
081110	92
081307	110
081308	110
081807	168
081808	168
082507	235
082508	235
101007	77
101010	77
101807	150
102007	170
102307	202
121207	80
121210	80
141709	146
142309	205
151507	120
151510	120
152004	170
152007	170
152010	170
152013	170
152016	170
152510	226
152513	226
161607	137

SPCM • SPCP series

Product no.	Matching DIN-Rail
081304	FDR - 50/100
081305	50/100
081306	50/100
081308	50/100
081310	50/100
081313	50/100
101004	80
101006	80
131304	100
131305	100
131306	100
131308	100
131310	100
131313	100
SPCM	
SPCP	
131804	100/150
131805	100/150
131806	100/150
131808	100/150
131810	100/150
131813	100/150
131815	100/150
181808	150
181810	150
181813	150
181815	150
182508	150/223
182510	150/223
182515	150/223

Accessories (Optional parts)

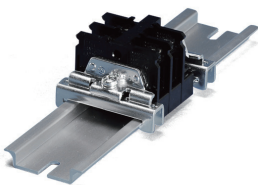

DIN-Rail stopper bracket TKR series
See page DIN-ACC-2

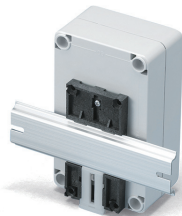

DIN-Rail mounting base DRA series
See page DIN-ACC-1

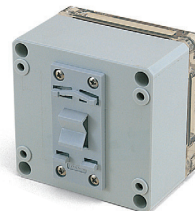

DIN-Rail mounting base DRT series
See page DIN-ACC-1

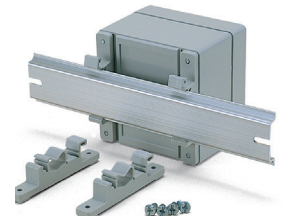

DIN-Rail mounting feet CKD series
See page DIN-ACC-2

DRA SERIES

DIN-RAIL MOUNTING BASE

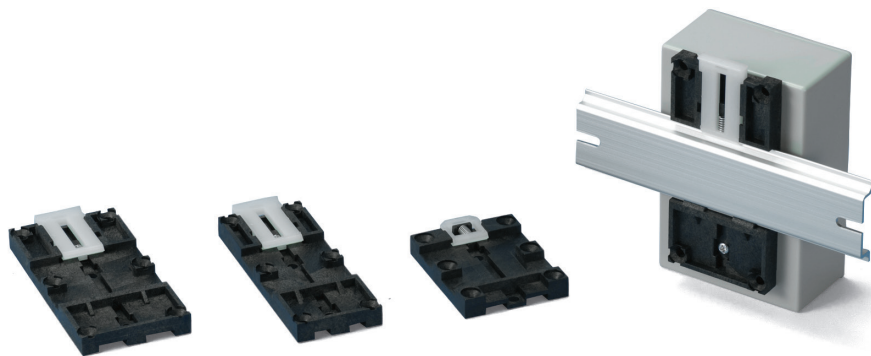

NOTE

Before installation, please ensure that the lever is not fully hidden behind the enclosure.

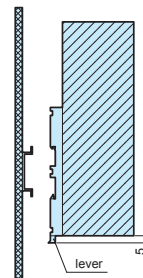

- For installation of enclosures, PCB and other parts onto a DIN rail.
- Simple installation and removal via the pull lever.

DRA-1

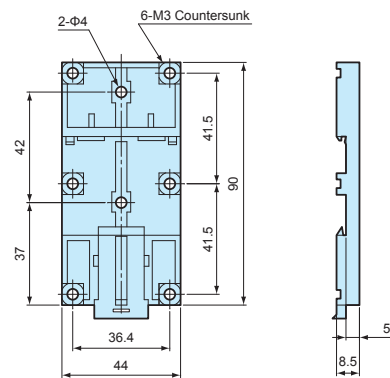

DRA-2

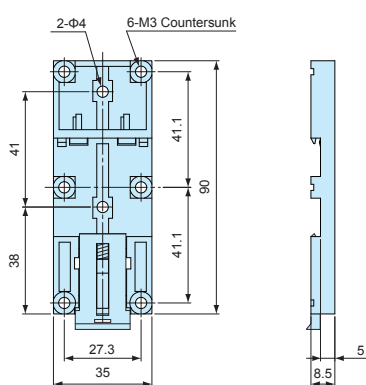

DRA-3

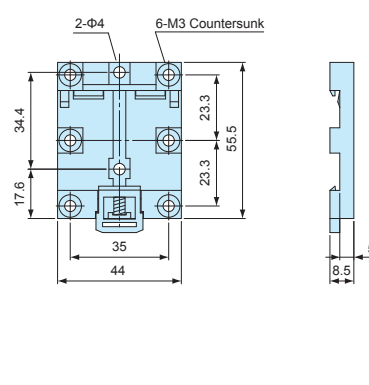

Product no. / Dimensions

Product no.	Material (body)	Material (lever)	Color	Weight (g)	Max load (kg)
DRA-1	PPE : SB UL94V-1	Nylon 66 UL94V-2	Black : Milky white	16.4	5
DRA-2	PPE : SB UL94V-1	Nylon 66 UL94V-2	Black : Milky white	14.5	5
DRA-3	PPE : SB UL94V-1	Nylon 66 UL94V-2	Black : Milky white	10.4	5

DRT SERIES

DIN-RAIL MOUNTING BASE

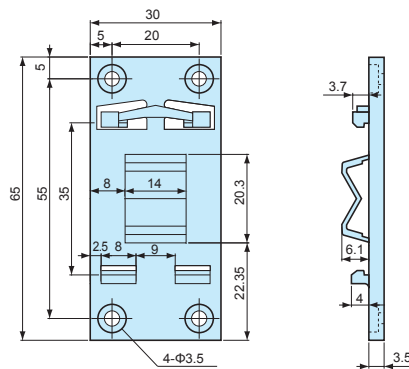
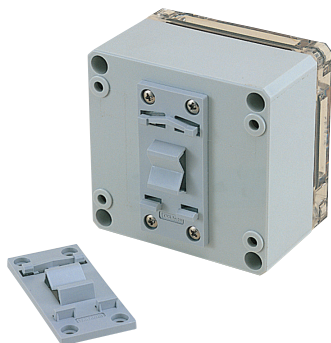

NOTE

Before installation, please ensure that the length (from top) of the enclosure is equal to, or less than 100mm from the center of the mounting base.

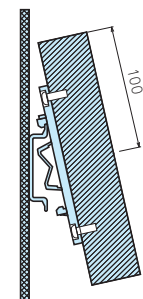

- For installation of enclosures, PCB and other parts onto a DIN rail.
- Simple installation and removal by tilting the case at an angle and sliding it in/out.

Product no. / Dimensions

Product no.	Material	Color	Weight (g)	Max load (kg)
DRT-1	PBT UL94V-0	Light gray	7.3	1

CKD SERIES

DIN-RAIL MOUNTING FEET

Installation example

■ DXF/DWG/PDF drawings available on our website.

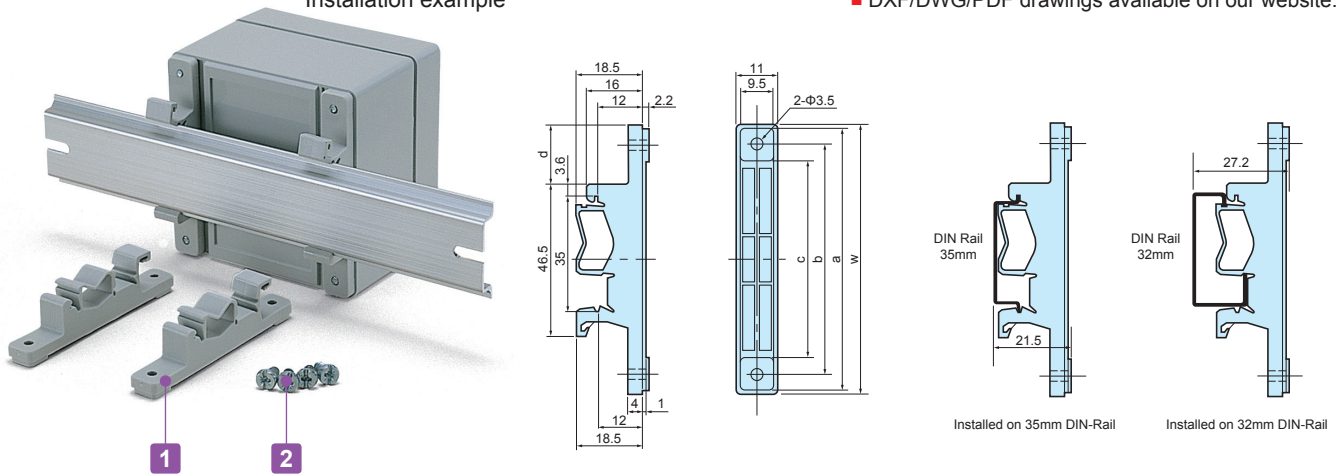

■ Mounting feet for installation of enclosures, PCB and other parts onto a DIN rail. Can be easily detached.

Technical Data
Max load : 3kg

Components

No.	Part name	Pcs	Material	Color / Finish
1	Mounting feet	2	Polyamide	White gray
2	Screw (special type 4.2 x 9.5)	4	Screw	Unichrome plated

Product no. / Dimensions

Product no.	W	a	b	c	d	Pack of
CKD- 80	77	75	66	56	17	2
CKD-120	117	115	106	96	37	2
CKD-160	157	155	147	136	57	2

TKR SERIES

DIN-RAIL TERMINAL BLOCKS END STOPPER

■ DXF/DWG/PDF drawings available on our website.

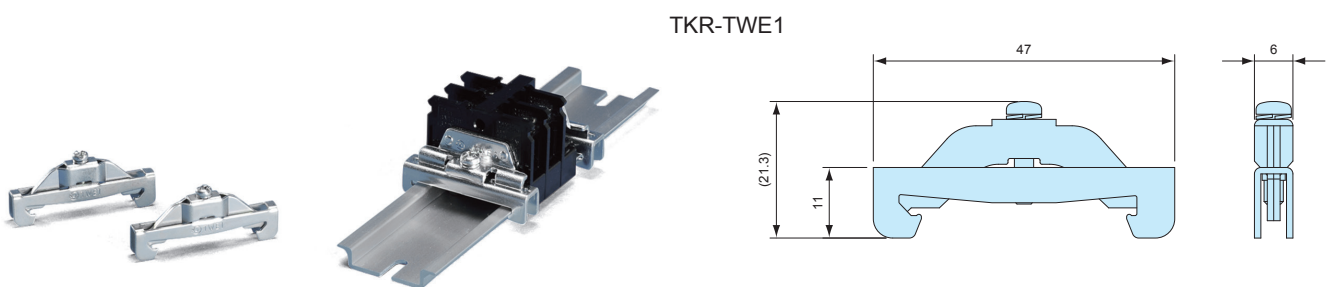

- Stopper bracket for use with 35mm DIN-rail to keep an attachment at a fixed location.
- TKR-TWE1 is used with small DIN rail attachment parts. For larger/higher attachment parts, TKR-JTXE3 is recommended for providing additional support.

Product no. / Feature

Product no.	Material	Color / Finish	Pack of
TKR-TWE1	Steel sheet	Trivalent chromate	2
TKR-JTXE3	Steel sheet	Trivalent chromate	2