

DRA SERIES

DIN-RAIL MOUNTING BASE

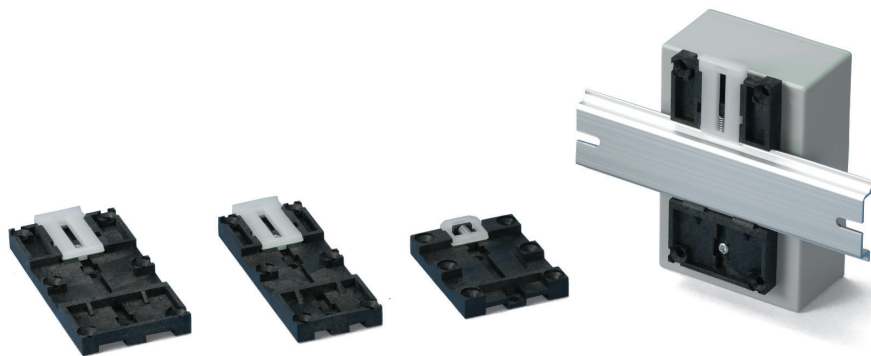

NOTE

Before installation, please ensure that the lever is not fully hidden behind the enclosure.

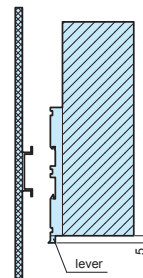

- For installation of enclosures, PCB and other parts onto a DIN rail.
- Simple installation and removal via the pull lever.

DRA-1

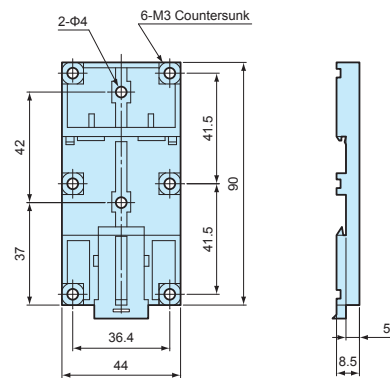

DRA-2

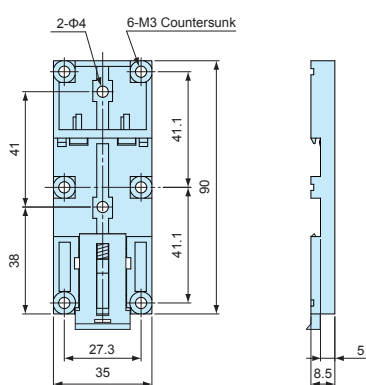

DRA-3

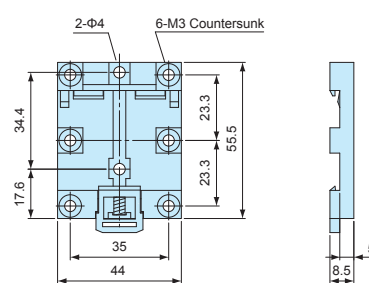

Product no. / Dimensions

Product no.	Material (body)	Material (lever)	Color	Weight (g)	Max load (kg)
DRA-1	PPE : SB UL94V-1	Nylon 66 UL94V-2	Black : Milky white	16.4	5
DRA-2	PPE : SB UL94V-1	Nylon 66 UL94V-2	Black : Milky white	14.5	5
DRA-3	PPE : SB UL94V-1	Nylon 66 UL94V-2	Black : Milky white	10.4	5

DRT SERIES

DIN-RAIL MOUNTING BASE

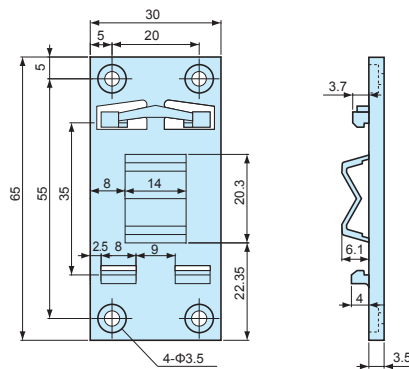
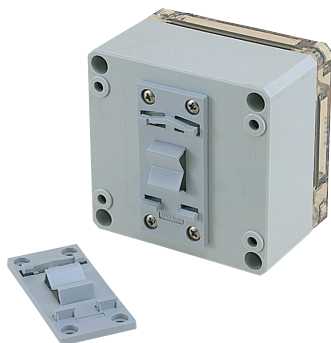

NOTE

Before installation, please ensure that the length (from top) of the enclosure is equal to, or less than 100mm from the center of the mounting base.

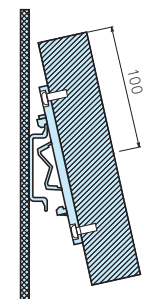

- For installation of enclosures, PCB and other parts onto a DIN rail.
- Simple installation and removal by tilting the case at an angle and sliding it in/out.

Product no. / Dimensions

Product no.	Material	Color	Weight (g)	Max load (kg)
DRT-1	PBT UL94V-0	Light gray	7.3	1