

外視

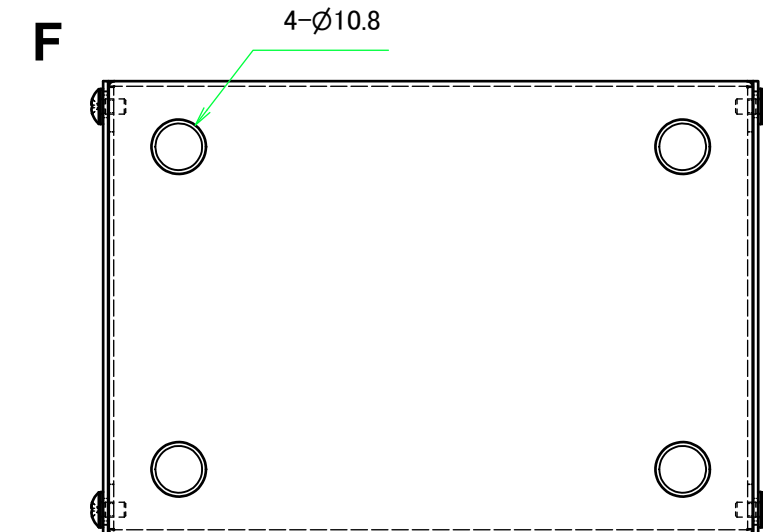

貼付ゴム足
(任意の位置に取付できます)

構成内容				
No.	名称	数量	材質	色・表面処理
1	カバー	1	アルミ板 A1050P t1.0	ヘアラインシルバーアルマイト
2	シャーシ	1	アルミ板 A1100P t1.0	ブラック・塗装
3	取付ビス(トラスM3 x 5)	4	真ちゆう	ニッケルメッキ
4	ワッシャー(M3用)	4	真ちゆう	ニッケルメッキ
5	ゴム足	4	合成ゴム	ブラック

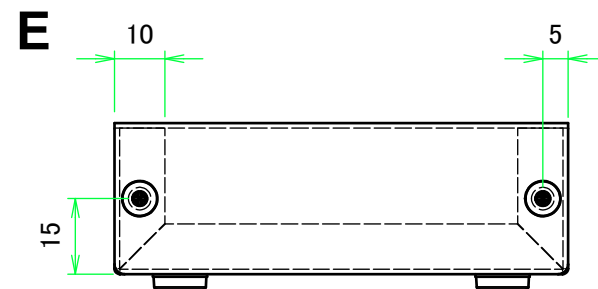
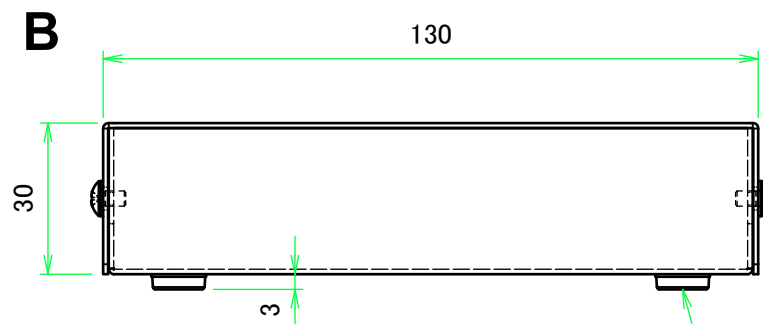
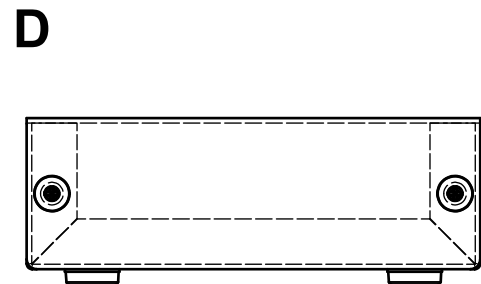
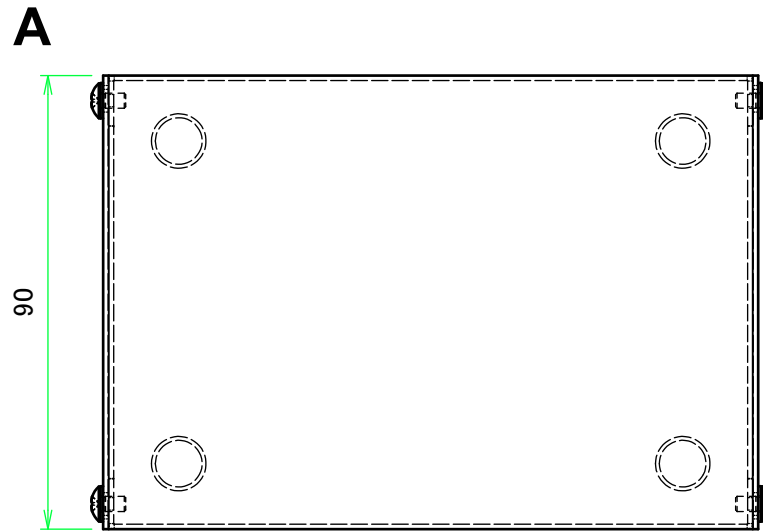
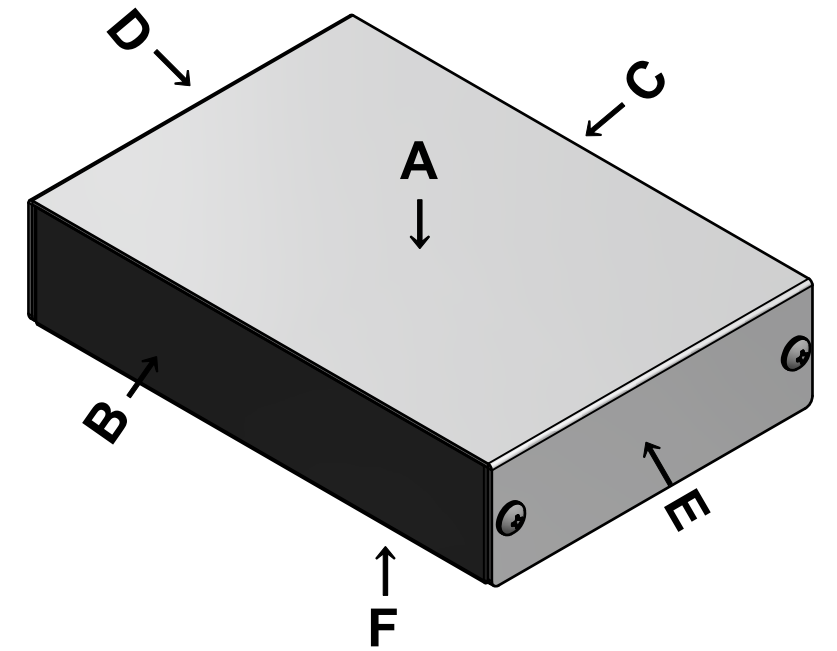
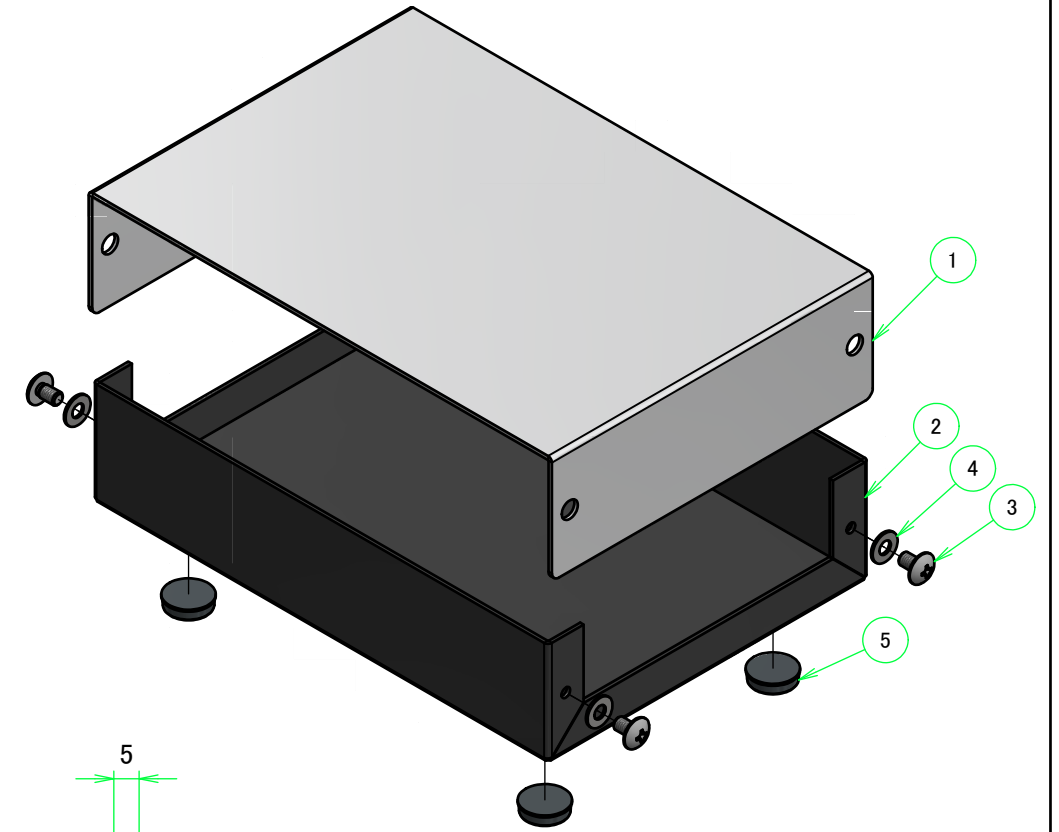

株式会社タカチ電機工業			品名 薄型アルミケース	尺度 1:1.5
承認 中根	検図 大江	製図 横田	型番 YM-130	
			作成日 2019/02/14	1 / 3

カバー

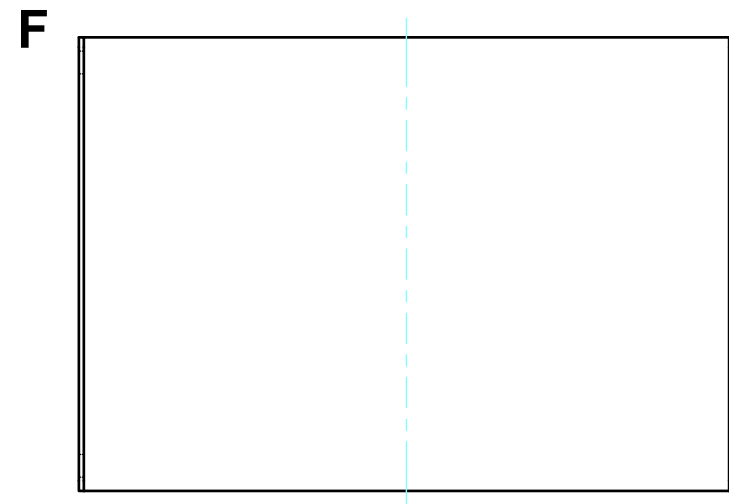
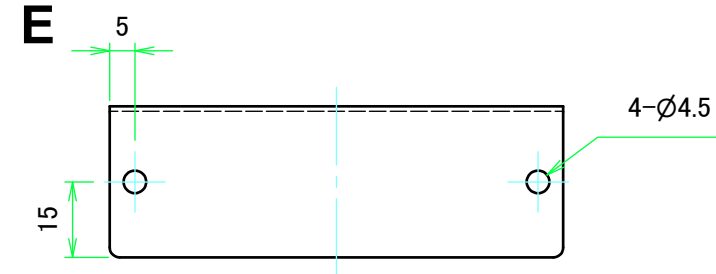
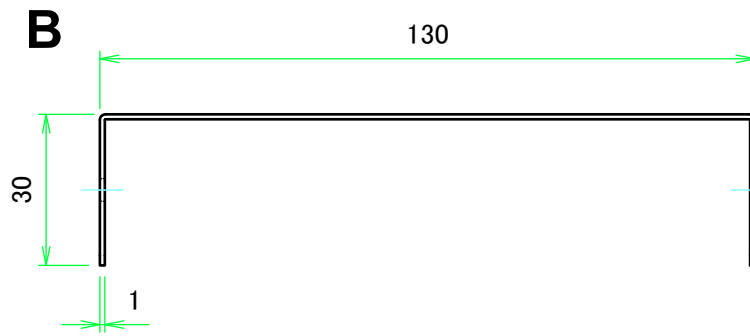
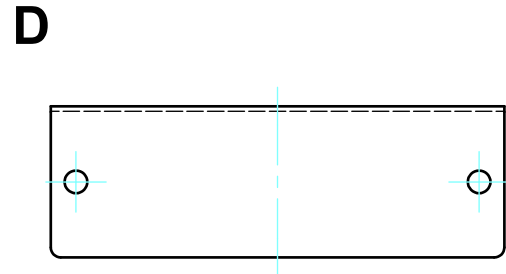
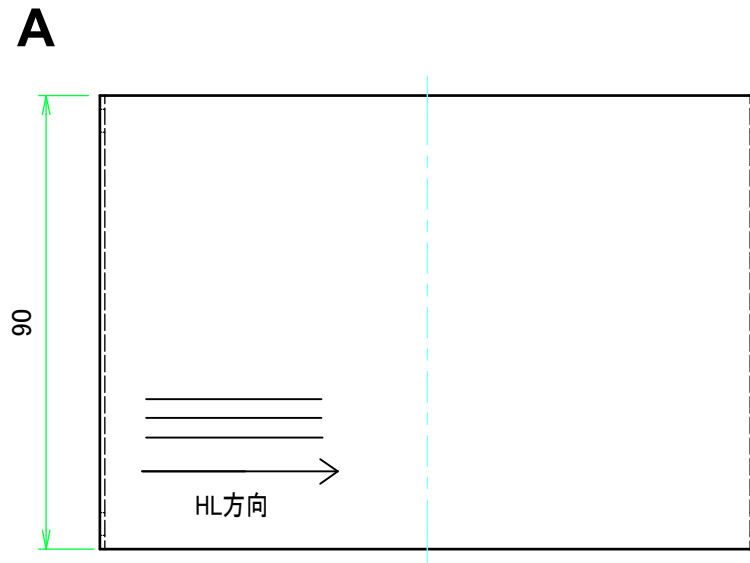

 株式会社タカチ電機工業			品名 薄型アルミケース	
承認	検図	製図	型番 YM-130	
中根	大江	横田	作成日 2019/02/14	2 / 3

シャーシ

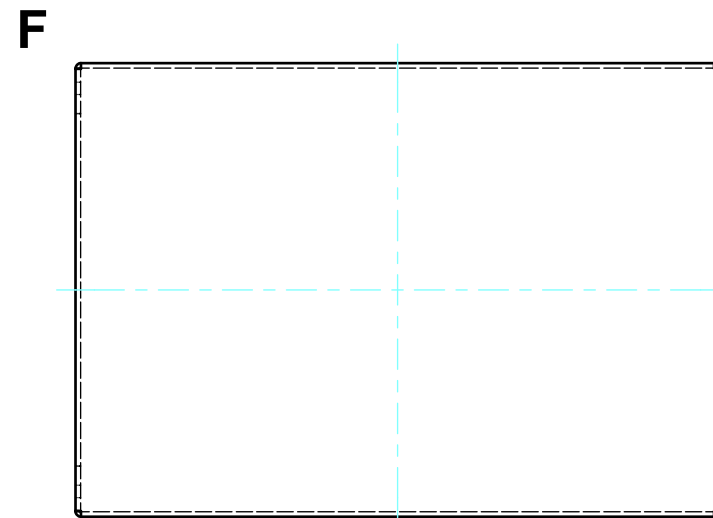
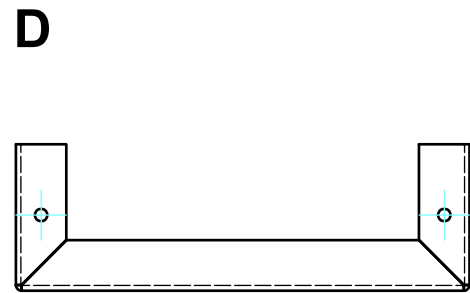
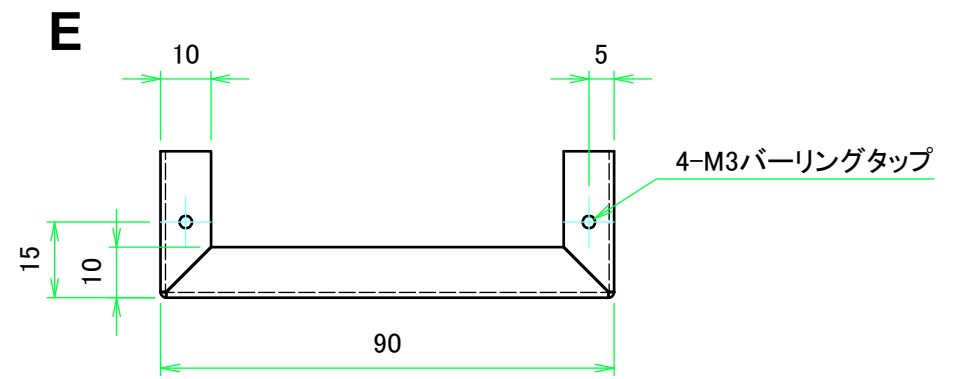
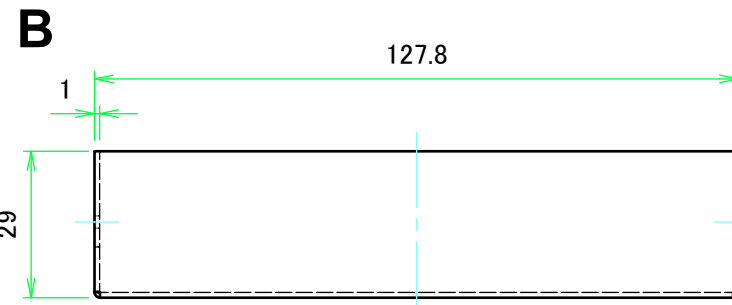
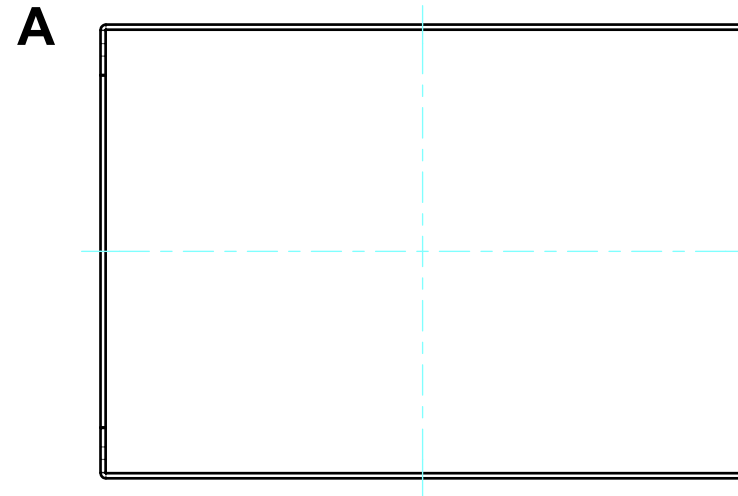
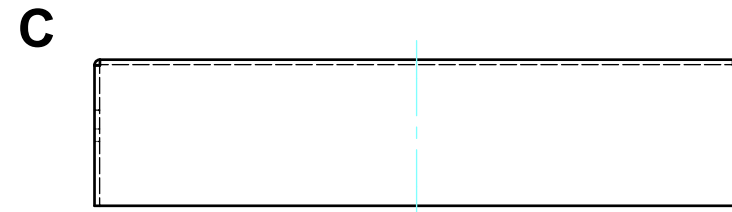

株式会社タカチ電機工業			品名 薄型アルミケース	
承認	検図	製図	型番 YM-130	
中根	大江	横田	作成日 2019/02/14	3 / 3