

No.	名称 / Part name	数量 / Pcs	材質 / Material	色・表面処理 / Color・Finish
1	グロメット / Grommet	1	PVC(硬度60°) PVC(hardness60°)	ブラック / Black

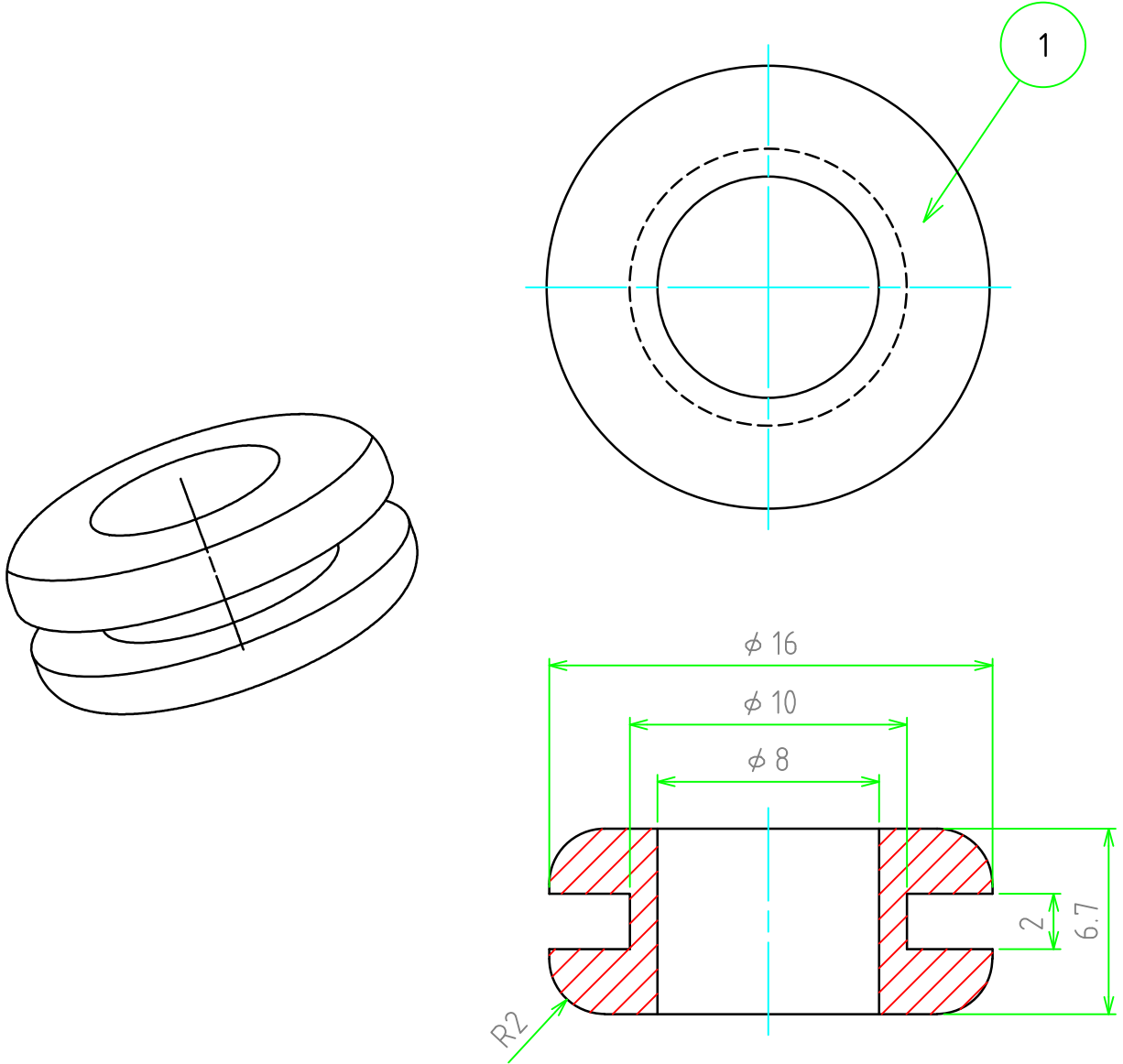

適合板厚範囲 : 1.8~2.0mm

適合穴径範囲 : 10.0~10.5mm

Applicable plate thickness range : 1.8 to 2.0mm

Applicable hole diameter range : 10.0 to 10.5mm

販売単位個数 : 10個(1袋)

Sales unit quantity : 10 pieces (1 bag)

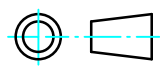
 株式会社タカチ電機工業 TAKACHI ELECTRONICS ENCLOSURE Co., LTD.			品名 / Title グロメット RUBBER GROMMET	 尺度 / Scale 4:1
承認 / Approved 中根	検図 / Checked 中根	製図 / Created 鎌田	型番 / Product number NG8-20	
			作成日 / Date 2023/03/30	