

# 外視 / External view

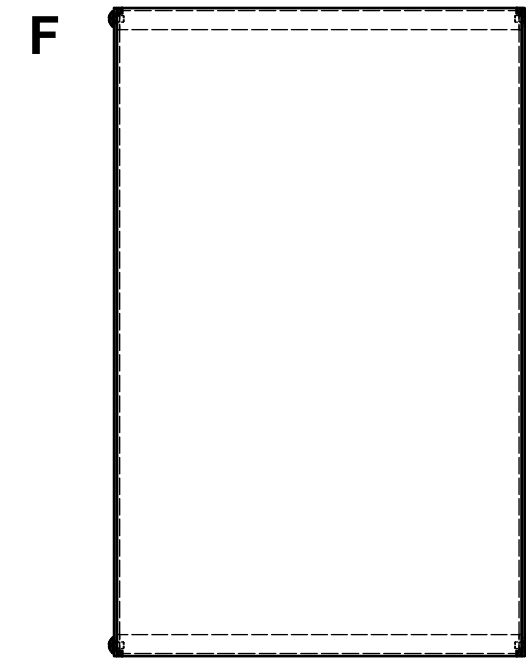

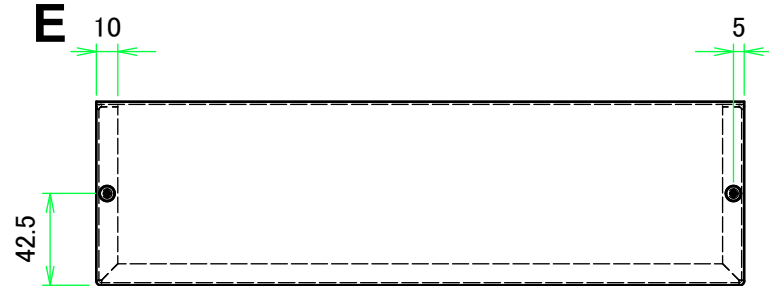

構成内容				
No.	名称	数量	材質	色・表面処理
1	カバー Cover	1	アルミ板 A1100P t1.2 Aluminium A1100P t1.2	表面 メタリックシルバー塗装, 裏面 導通処理 Metallic silver painted, Inside Conductivefinished
2	シャーシ Base	1	アルミ板 A1100P t1.2 Aluminium A1100P t1.2	表面 メタリックシルバー塗装, 裏面 導通処理 Metallic silver painted, Inside Conductivefinished
3	取付ビス(トラスM3 x 5) Screw(Truss head M3 - 5)	4	真ちゆう Brass	ニッケルメッキ Nickel Plated
4	ワッシャー(M3用) Washer(M3)	4	真ちゆう Brass	ニッケルメッキ Nickel Plated

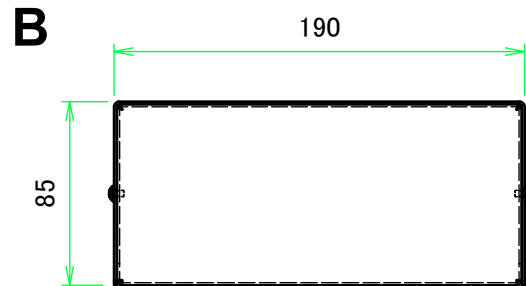
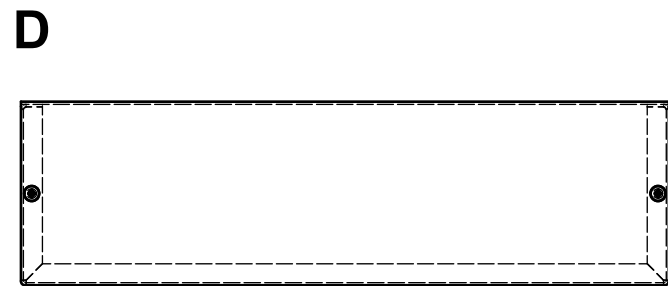
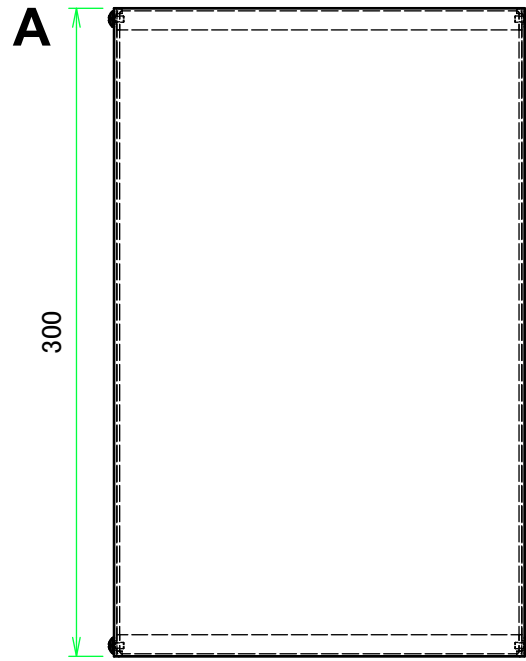
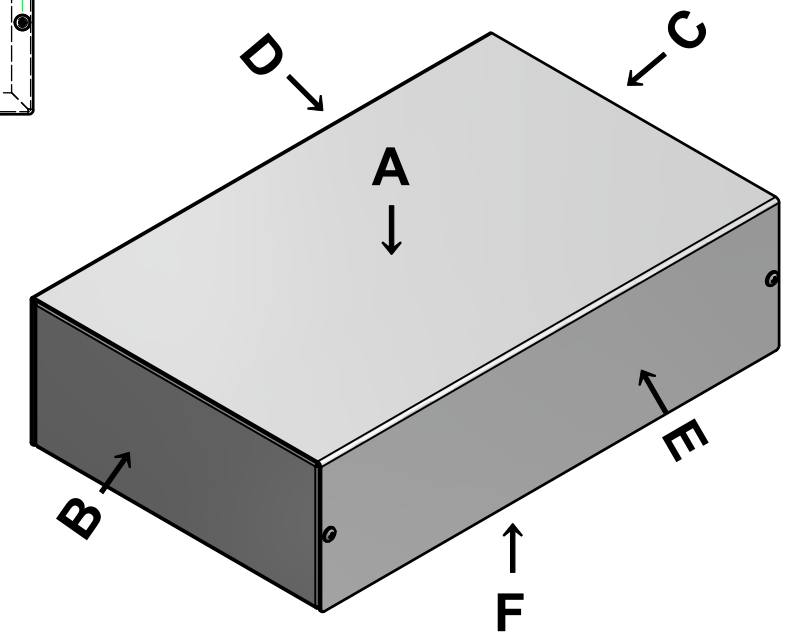
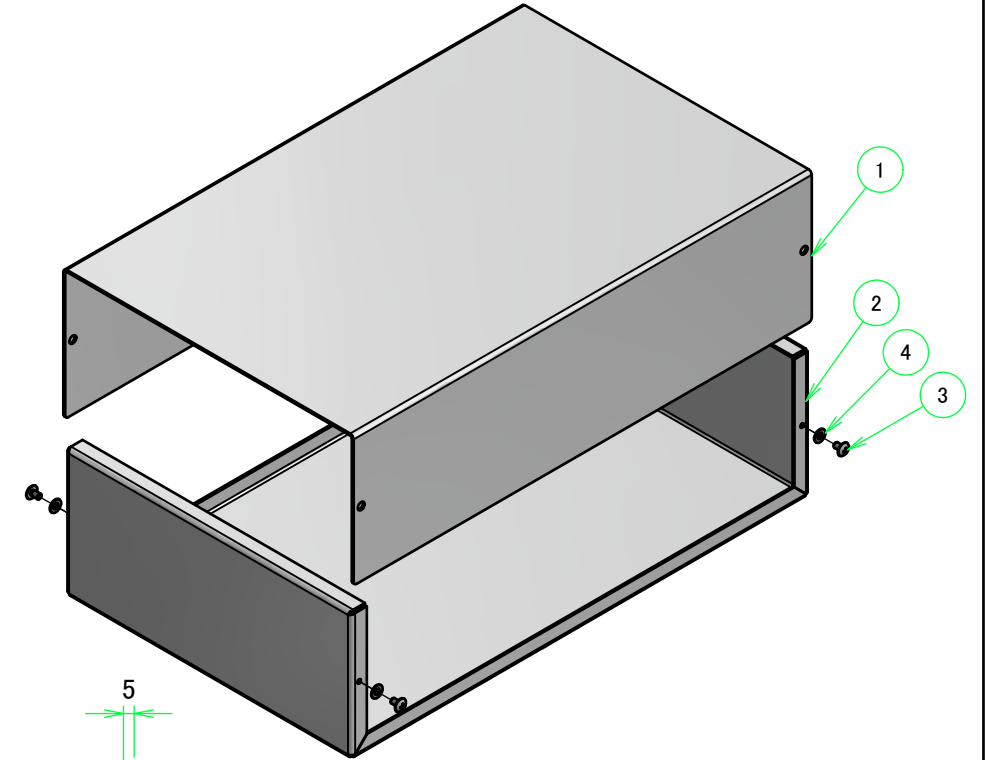

<b>株式会社タカチ電機工業</b> TAKACHI ELECTRONICS ENCLOSURE CO., LTD.			品名/Title アルミケース ALUMINIUM CASE	尺度/Scale 1:3.5
承認/Approved	検図/Checked	製図/Created	型番/Product number MB19-9-30	
中根	王	横田	作成日/Date 2019/12/20	1 / 3

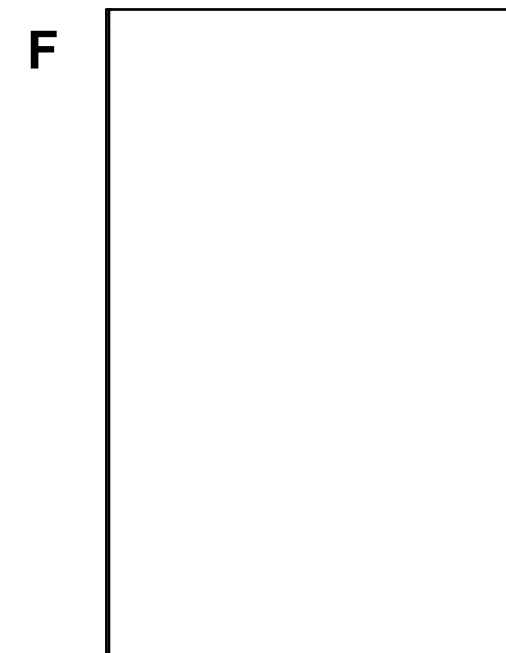
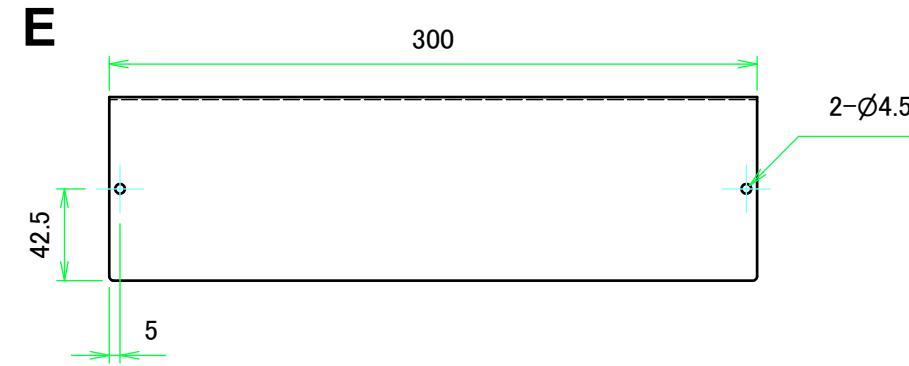
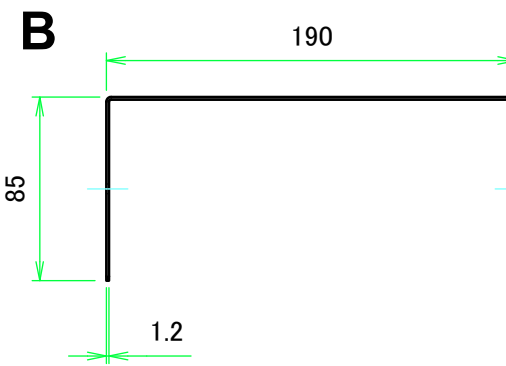
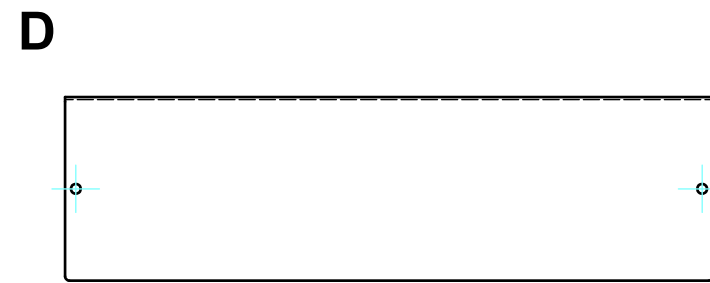
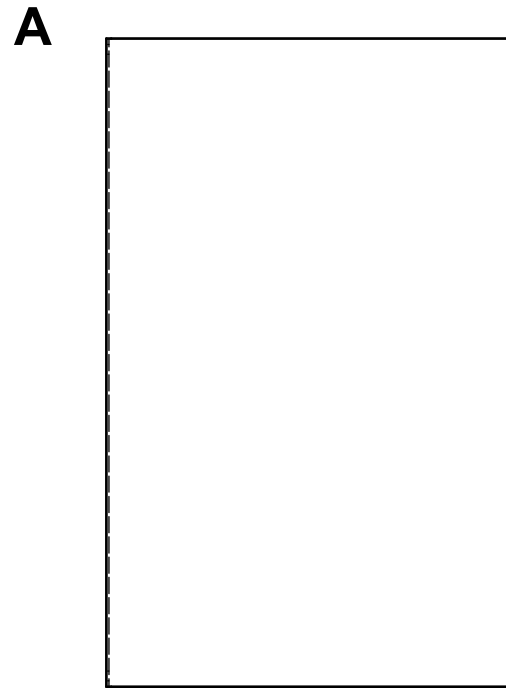
カバー / Cover

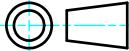

 株式会社タカチ電機工業 TAKACHI ELECTRONICS ENCLOSURE CO., LTD.			品名/Title アルミケース ALUMINIUM CASE	 尺度/Scale 1:3.5
承認/Approved 中根	検図/Checked 王	製図/Created 横田	型番/Product number MB19-9-30	
			作成日/Date 2019/12/20	2 / 3

シャーシ / Base

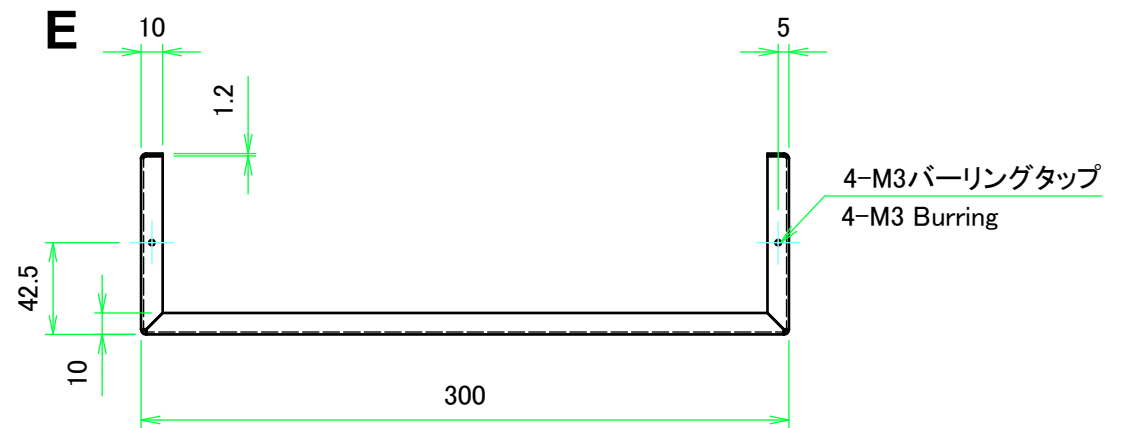
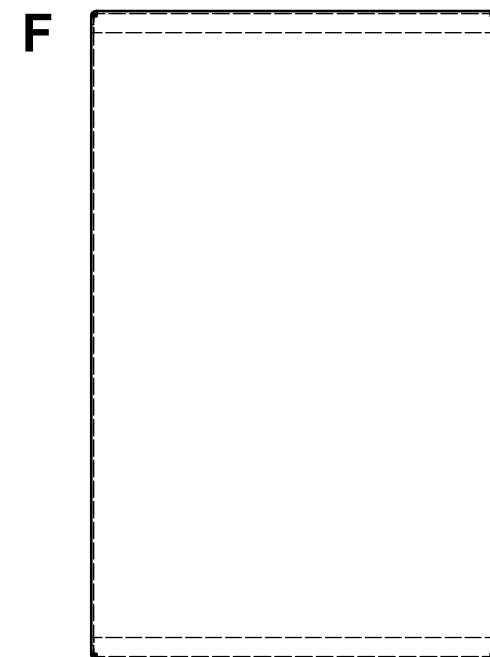
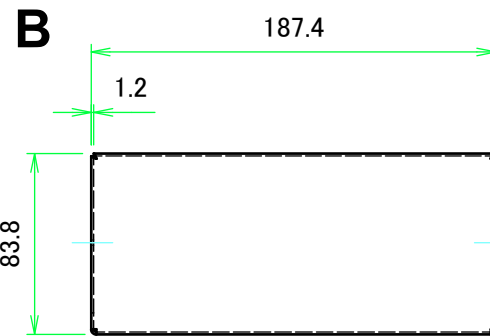
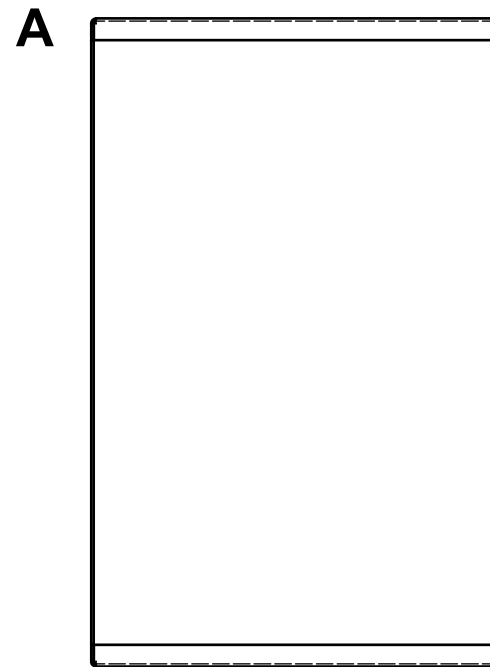

株式会社タカチ電機工業 TAKACHI ELECTRONICS ENCLOSURE CO., LTD.			品名/Title アルミケース ALUMINIUM CASE	尺度/Scale 1:3.5
承認/Approved	検図/Checked	製図/Created	型番/Product number MB19-9-30	
中根	王	横田	作成日/Date 2019/12/20	3 / 3