

構成内容 / Components				
No.	名称 / Part name	数量 / Pcs	材質 / Material	色・表面処理 / Color・Finish
1	シャーシ Mounting plate	1	アルミ板 A1050P t=2.0 Aluminium A1050P t=2.0	無処理 Unfinished
2	固定金具 Mounting bracket	4	鋼板 SECC t=1.6 Steel SECC t=1.6	ジンコート21 Zinc coated
3	板ナット M3 nut	4	鋼板 SPCC t=1.6 Steel SPCC t=1.6	三価クロメート Trivalent chromate
4	ナットホルダー Nut holder	4	POM	ブラック Black
5	取付ビス(M3 x 6 ナベ) Screw (M3 - 6 Pan head)	8	鉄 Steel	三価クロメート Trivalent chromate

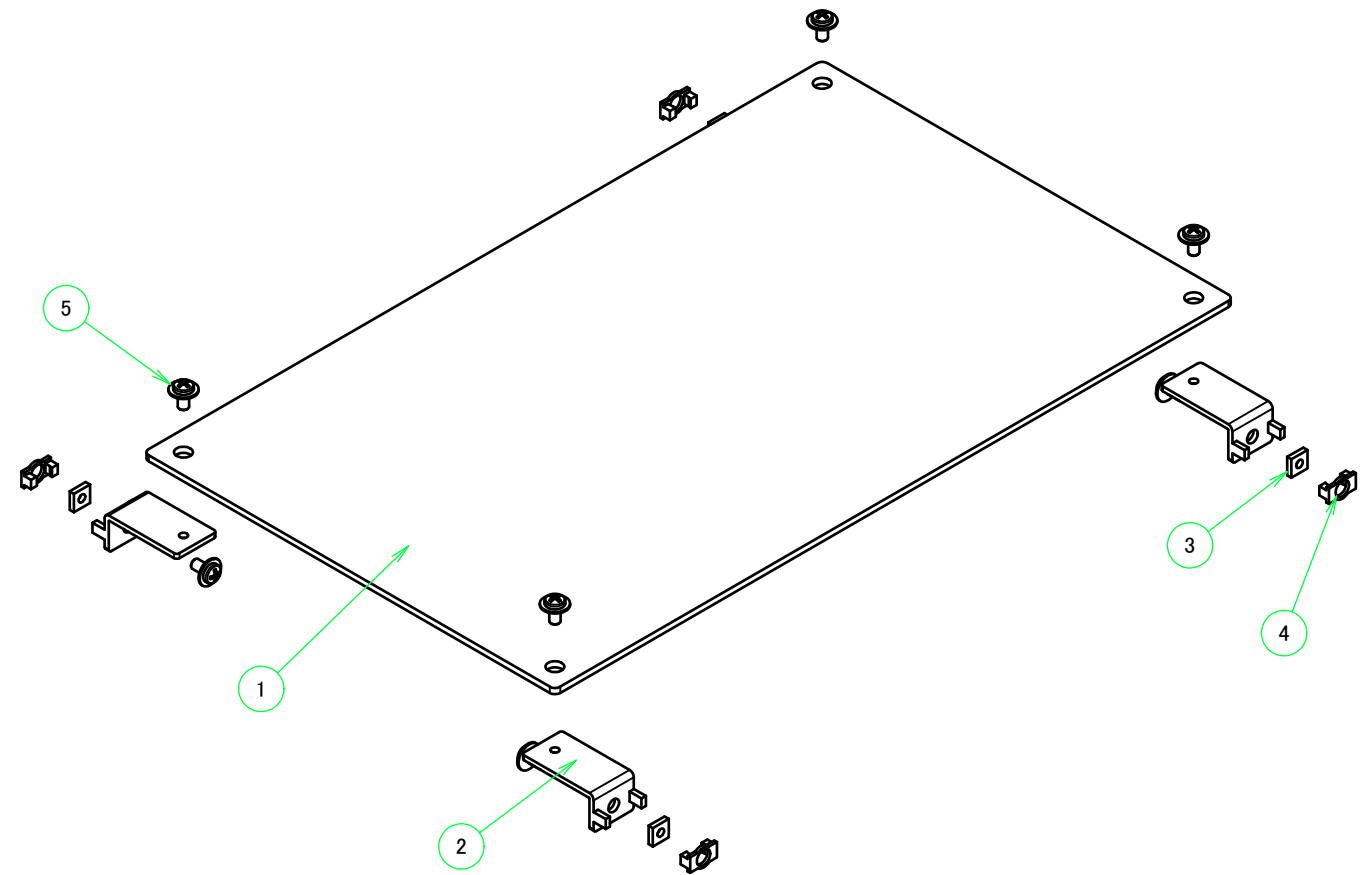

取付方法 / How to fix

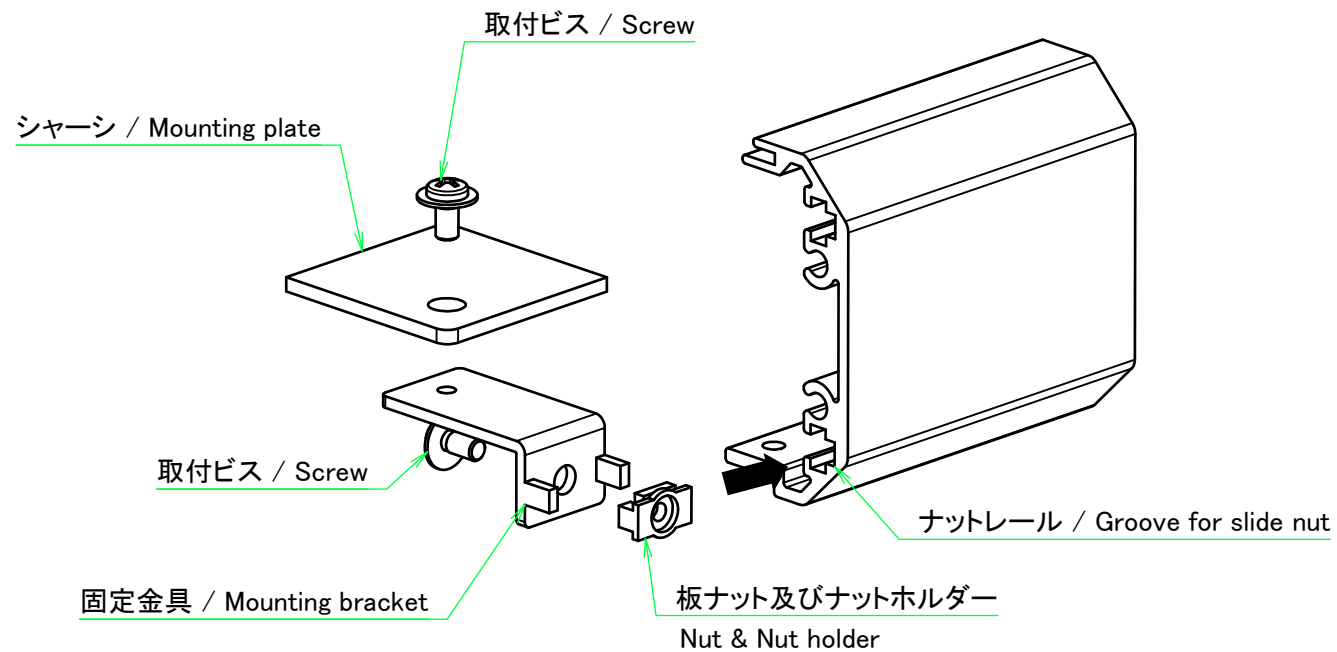

■テクニカルデータ / Technical Data■

対応ケース / Suitable : FC□-30-25
FCW□-25-30
FCH□-30-25

※FC4シリーズには使用いただけません。
Not suitable for FC4 (H=37.9mm)

株式会社タカチ電機工業 TAKACHI ELECTRONICS ENCLOSURE CO., LTD.			品名/Title FC・FCW・FCH専用シャーシ MOUNTING PLATE for FC,FCW,FCH	尺度/Scale 1 / 3
承認/Approved 中根	検図/Checked 王	製図/Created 常山	型番/Product number FCC30-25-1 作成日/Date 2020/01/06	

シャーシ / Mounting plate

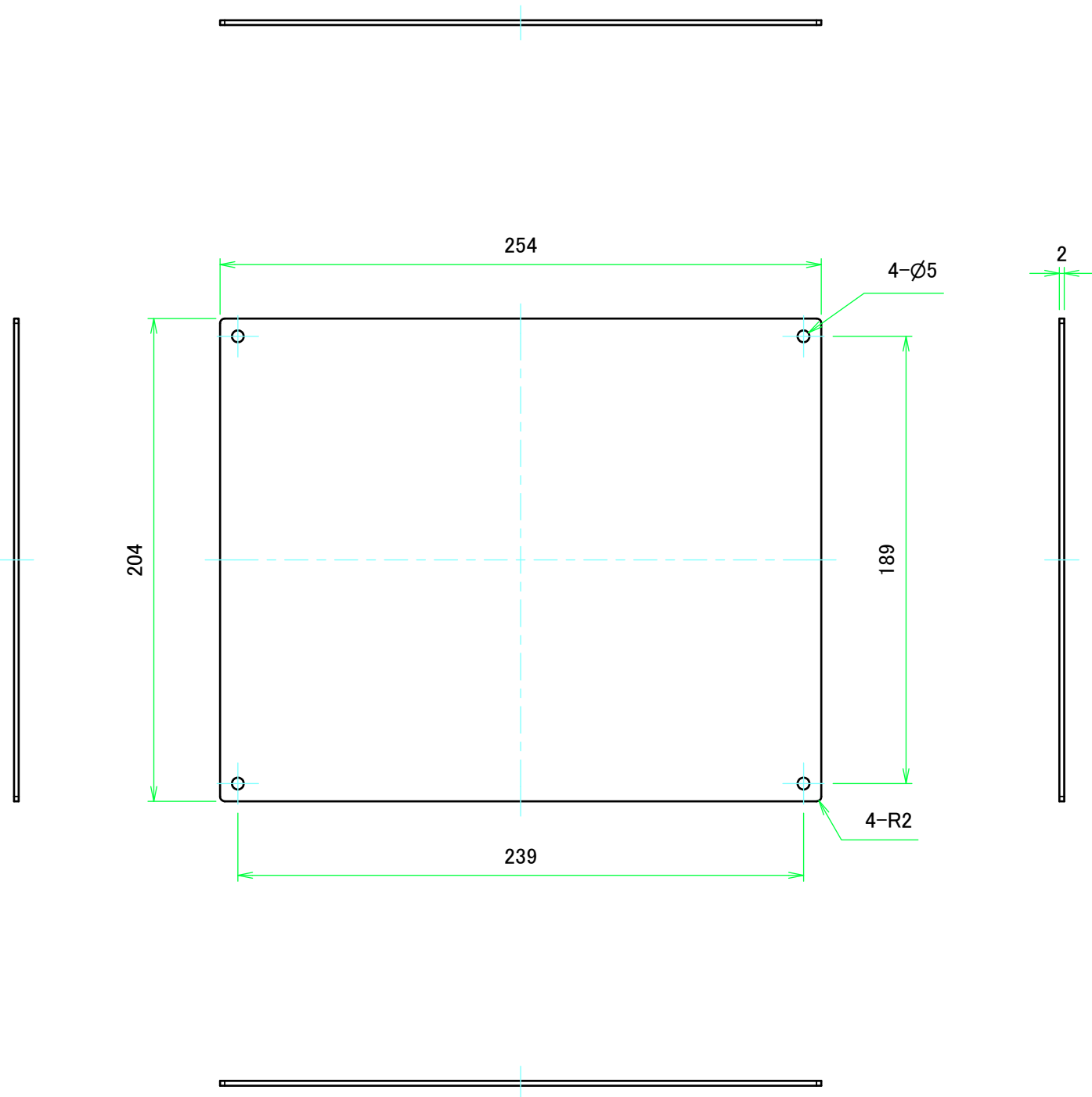

有効寸法 / Max dim.

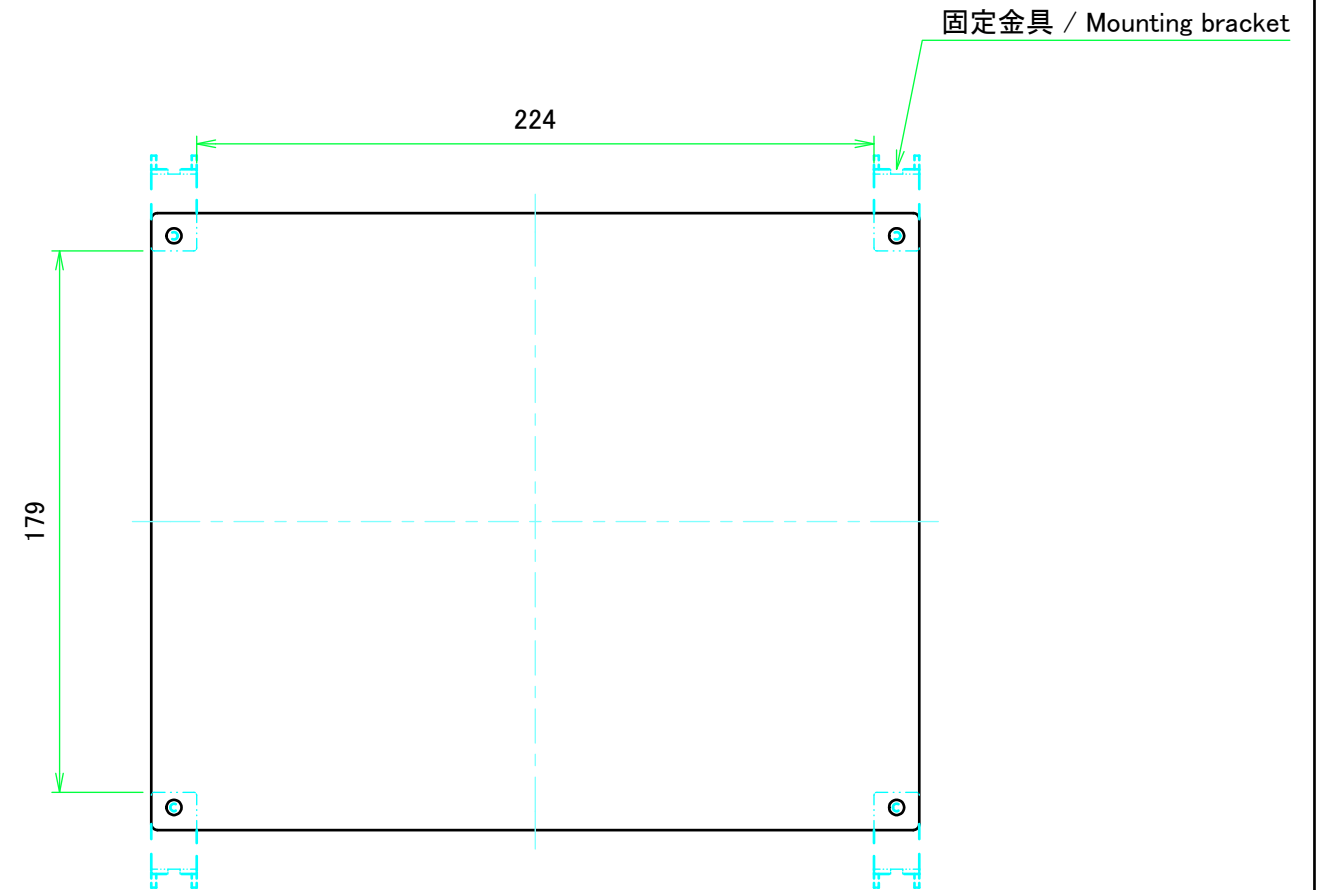

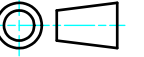
 株式会社タカチ電機工業 TAKACHI ELECTRONICS ENCLOSURE CO., LTD.			品名/Title FC・FCW・FCH専用シャーシ MOUNTING PLATE for FC,FCW,FCH	 尺度/Scale 1:2.5
承認/Approved	検図/Checked	製図/Created	型番/Product number FCC30-25-1	
中根	王	常山	作成日/Date 2020/01/06	2 / 3

固定金具 / Mounting bracket

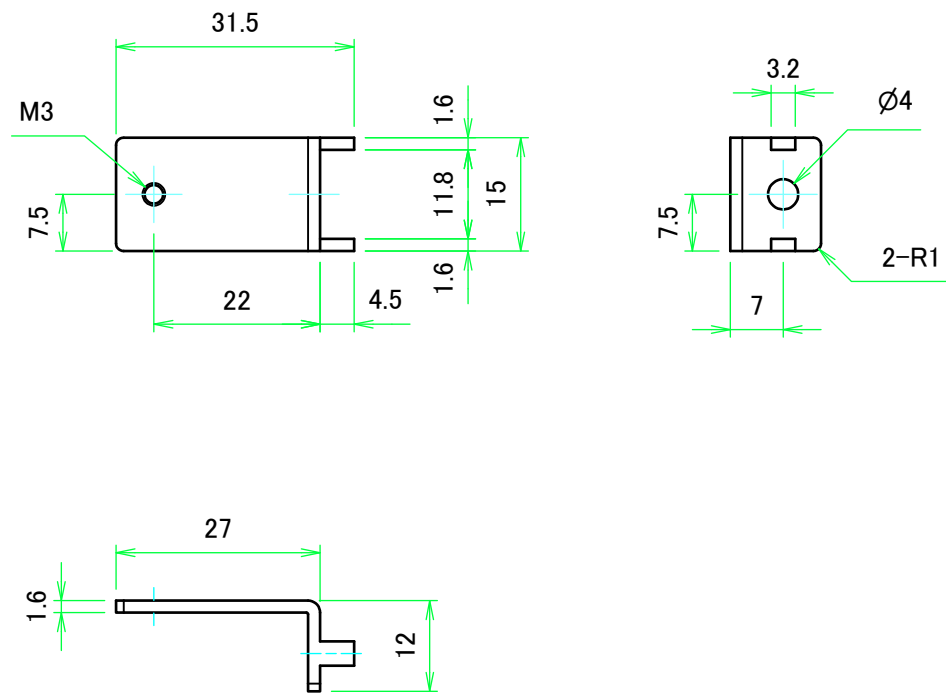

ナットホルダー / Nut holder

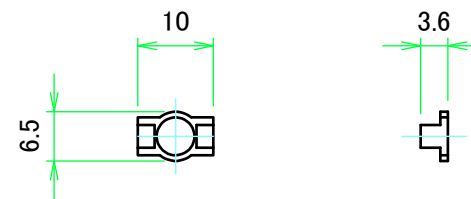

板ナット / M3 nut

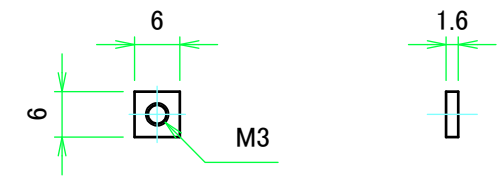

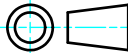
 株式会社タカチ電機工業 TAKACHI ELECTRONICS ENCLOSURE CO., LTD.			品名/Title FC・FCW・FCH専用シャーシ MOUNTING PLATE for FC,FCW,FCH	 尺度/Scale 1:1
承認/Approved	検図/Checked	製図/Created	型番/Product number FCC30-25-1	
中根	王	常山	作成日/Date 2020/01/06	3 / 3