

構成内容 / Components				
No.	名称 / Part name	数量 / Pcs	材質 / Material	色・表面処理 / Color・Finish
1	フレーム Frame	4	アルミ押出材 A6063S-T5 Extruded aluminium A6063S-T5	シルバーアルマイト, ブラックアルマイト Silver, Black・Anodized
2	コーナーブロック Corner block	4	ABS樹脂 UL94HB ABS UL94HB	ライトグレー, ブラック Light gray, Black
3	コーナーキャップ / Blind plug	8	エラストマ / TPE	ライトグレー, ブラック / Light gray, Black
4	ハメ込みパネル / Slide panel	1	アルミ板 / Aluminium A1100P t=1.5 アルミ板 / Aluminium A1100P t=1.5	シルバーアルマイト / Silver・Anodized ブラック・塗装 / Black・Painted
5	ねじ止めパネル / Screwed panel	1	アルミ板 / Aluminium A1100P t=1.5 アルミ板 / Aluminium A1100P t=1.5	シルバーアルマイト / Silver・Anodized ブラック・塗装 / Black・Painted
6	取付ビス(M4 x 15 ナベ) Screw (M4 - 15 Pan head)	16	鉄 Steel	三価クロメート Trivalent chromate
7	取付ビス(M3 x 5 座付丸皿) Screw (M3 - 5 Slotted raised countersunk)	8	鉄 Steel	ニッケルメッキ, 三価黒クロメート Nickel plated, Black trivalent chromate

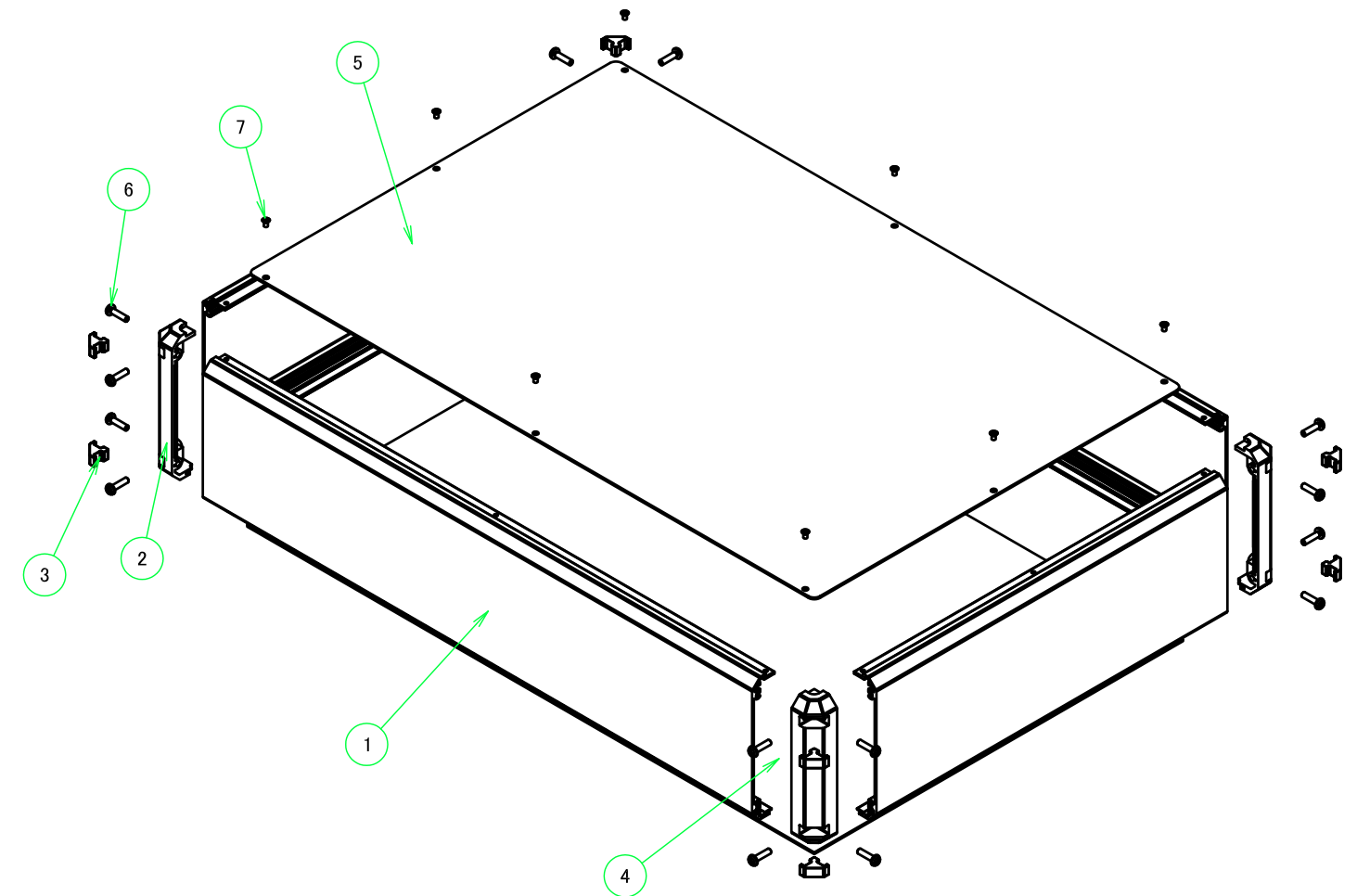
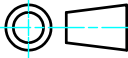

色仕様(型番末尾□) / Color Type(End of product number□)			
記号 / Code	パネル / Panel	フレーム / Frame	コーナー / Corner
G S	シルバー / Silver	シルバー / Silver	ライトグレー / Light gray
B S	シルバー / Silver	シルバー / Silver	ブラック / Black
B X	シルバー / Silver	ブラック / Black	ブラック / Black
B B	ブラック / Black	ブラック / Black	ブラック / Black

TAKACHI 株式会社タカチ電機工業 TAKACHI ELECTRONICS ENCLOSURE CO., LTD.		品名/Title コントロールボックス ALUMINIUM CONTROL BOX	 尺度/Scale 1:5
承認/Approved 中根	検図/Checked 大江	製図/Created 常山	
		型番/Product number FC13-60-40□	1 / 7
		作成日/Date 2020/07/22	

外視図，内視図 / External View, Internal View

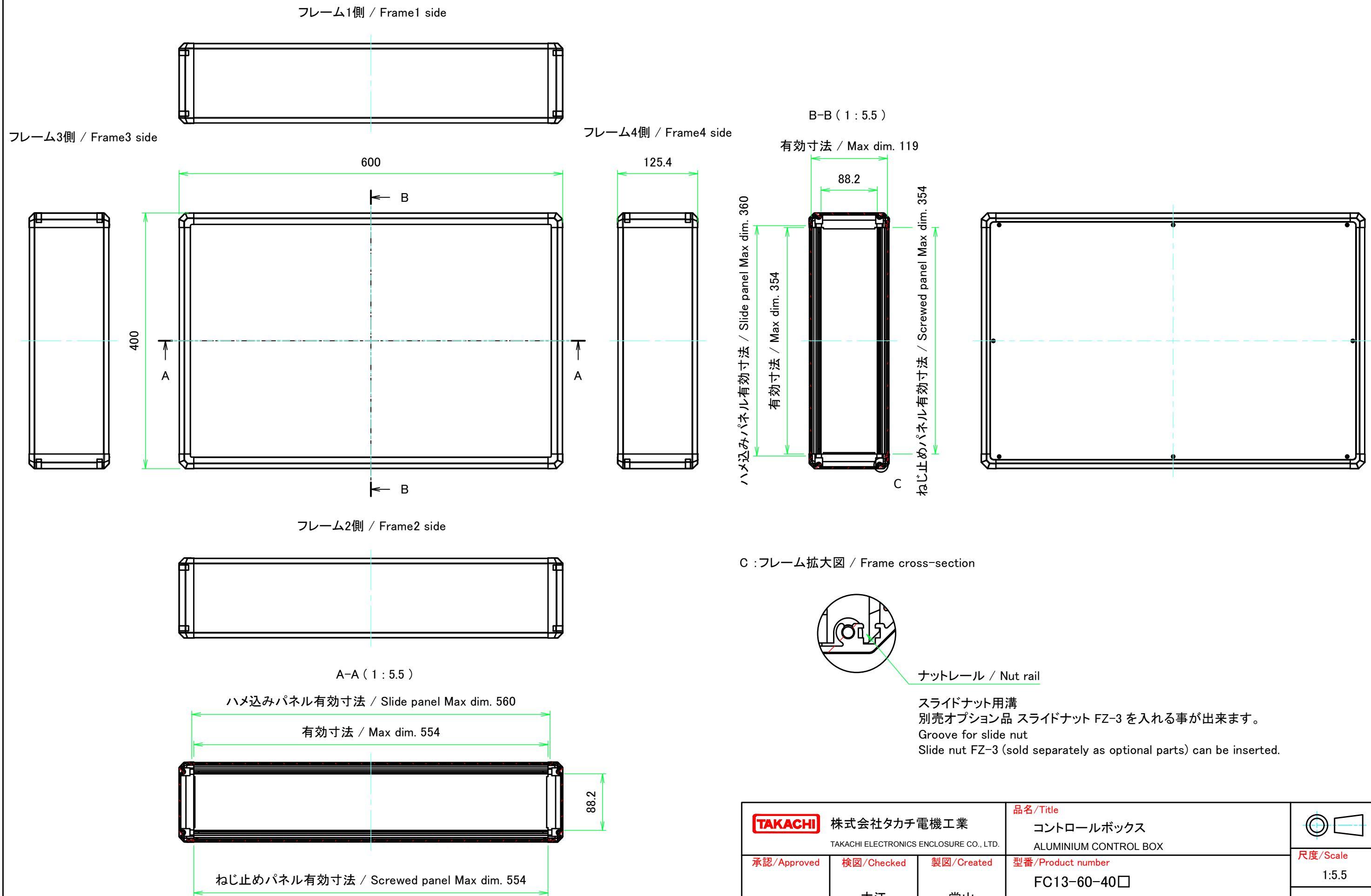

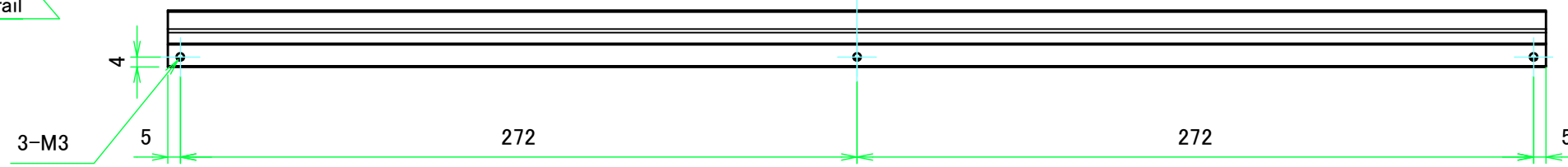
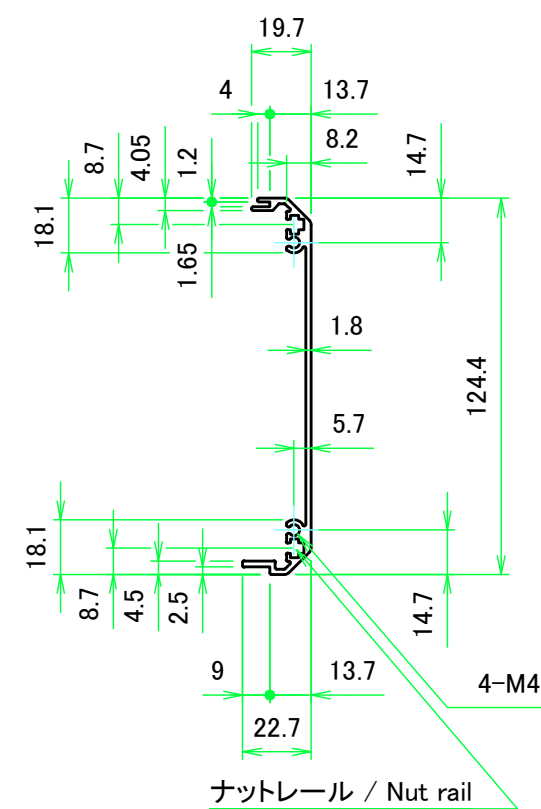
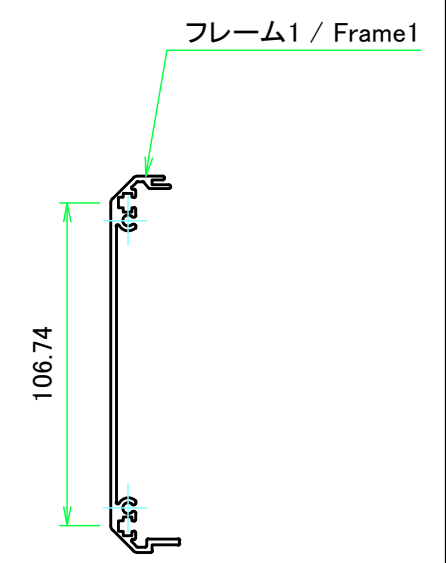
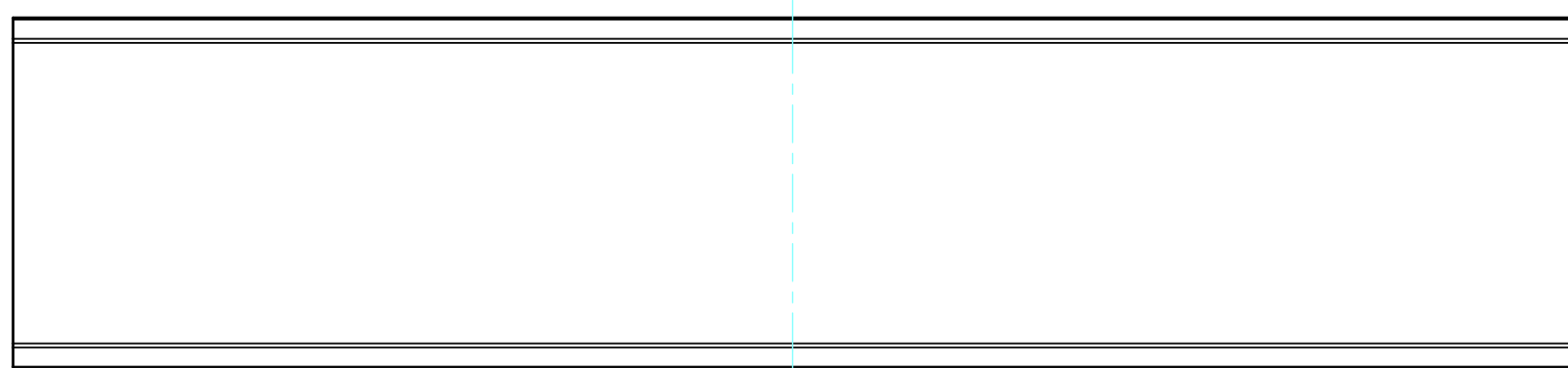
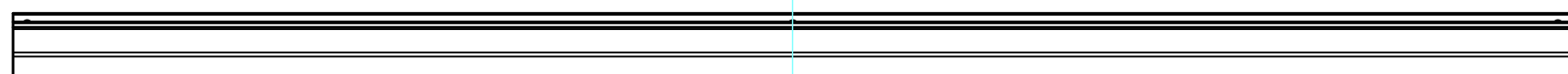
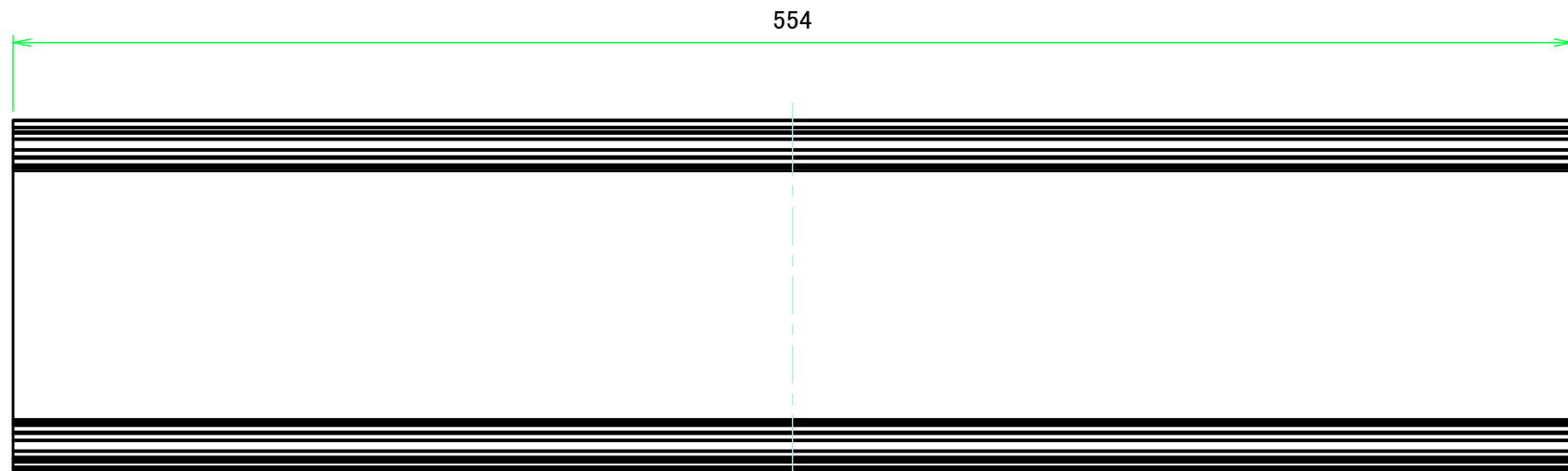

C : フレーム拡大図 / Frame cross-section

		株式会社タカチ電機工業 TAKACHI ELECTRONICS ENCLOSURE CO., LTD.		品名/Title コントロールボックス ALUMINIUM CONTROL BOX	尺度/Scale 1:5.5
承認/Approved	検図/Checked	製図/Created	型番/Product number	FC13-60-40□	
	大江	常山	作成日/Date		2017/08/31



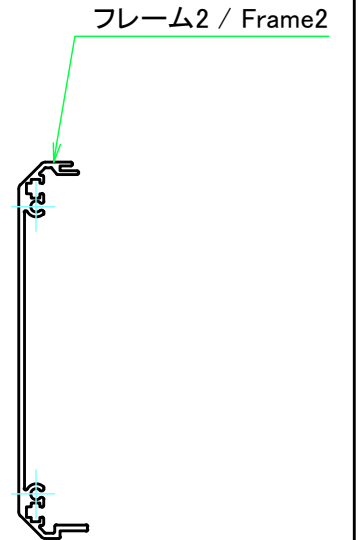
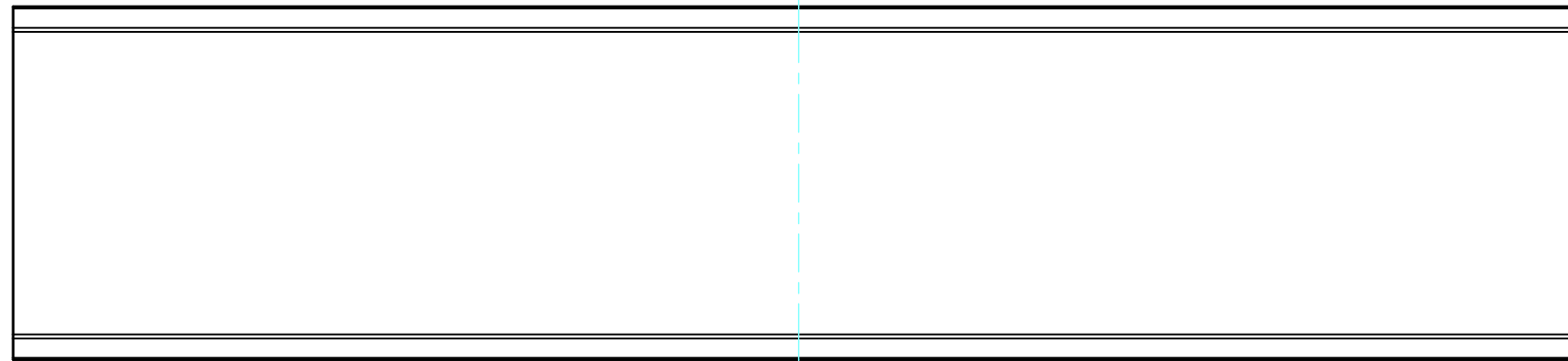
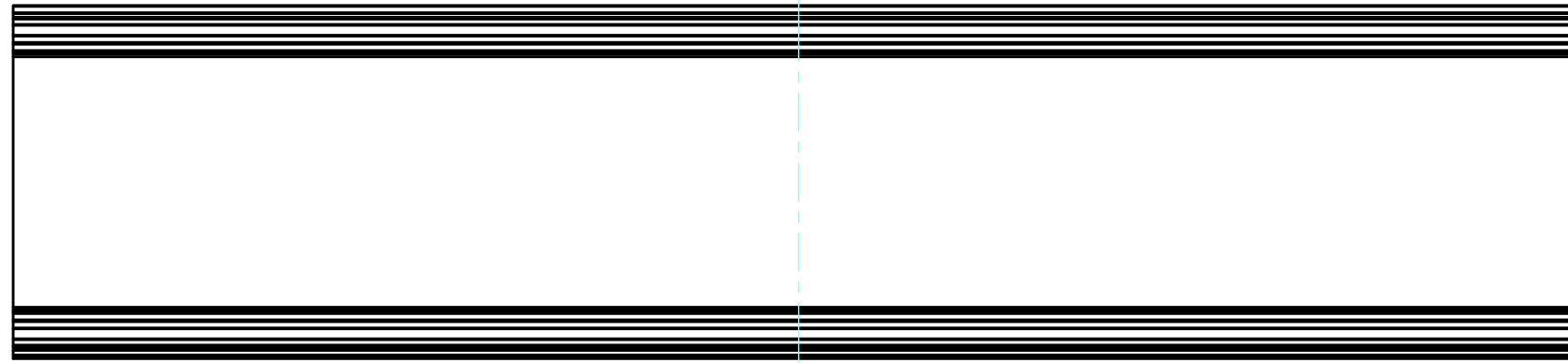

株式会社タカチ電機工業 TAKACHI ELECTRONICS ENCLOSURE CO., LTD.		品名/Title フレーム1 Frame1	尺度/Scale 1:2.5
承認/Approved	検図/Checked	製図/Created	
	大江	常山	作成日/Date 2017/08/31 3 / 7

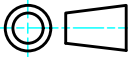

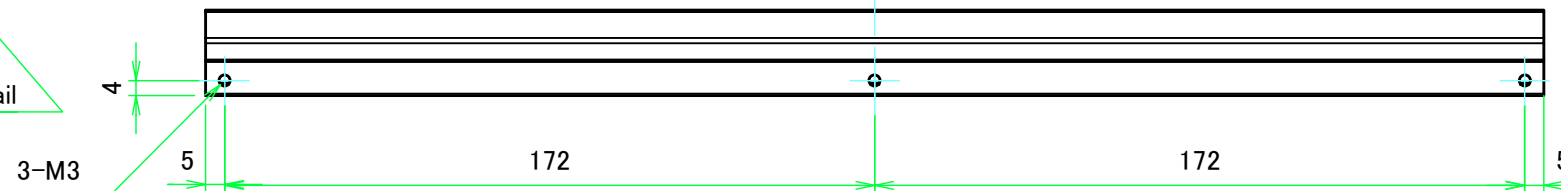
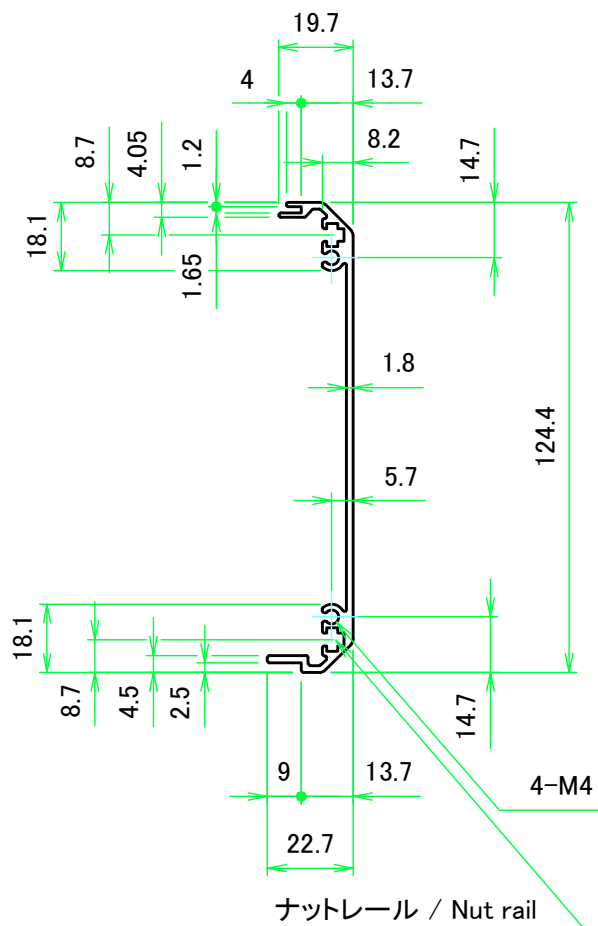
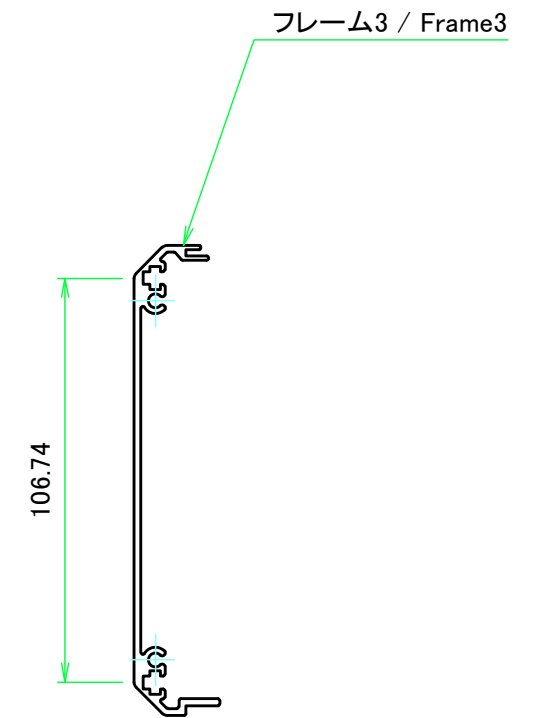
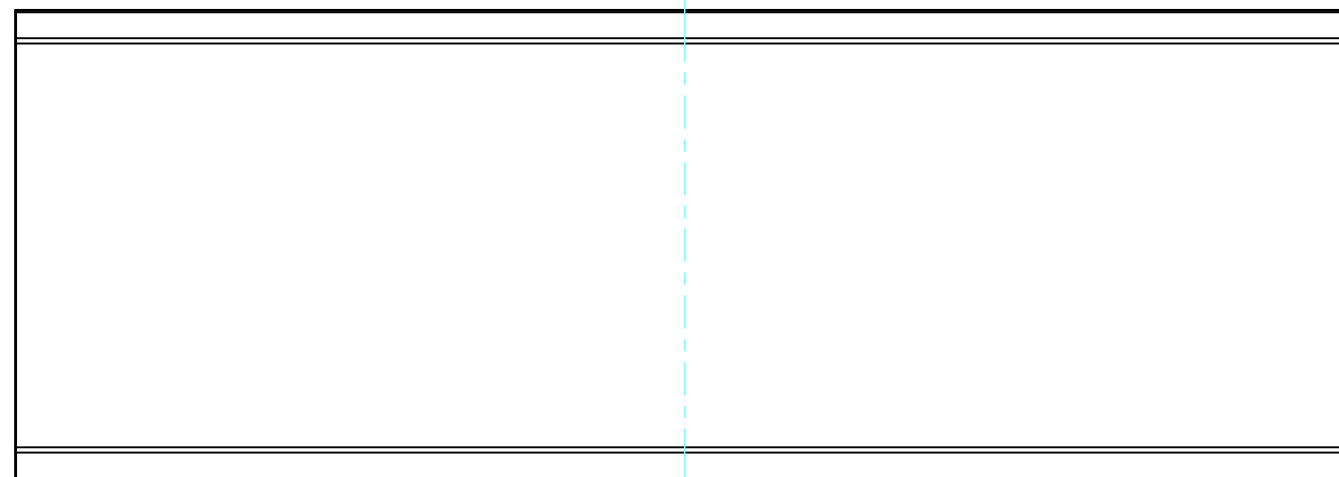
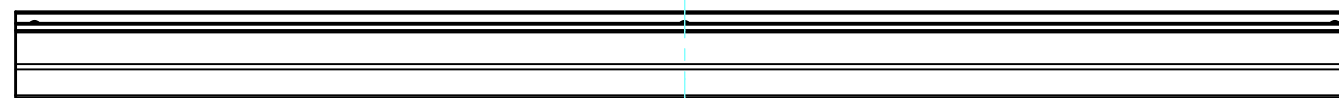
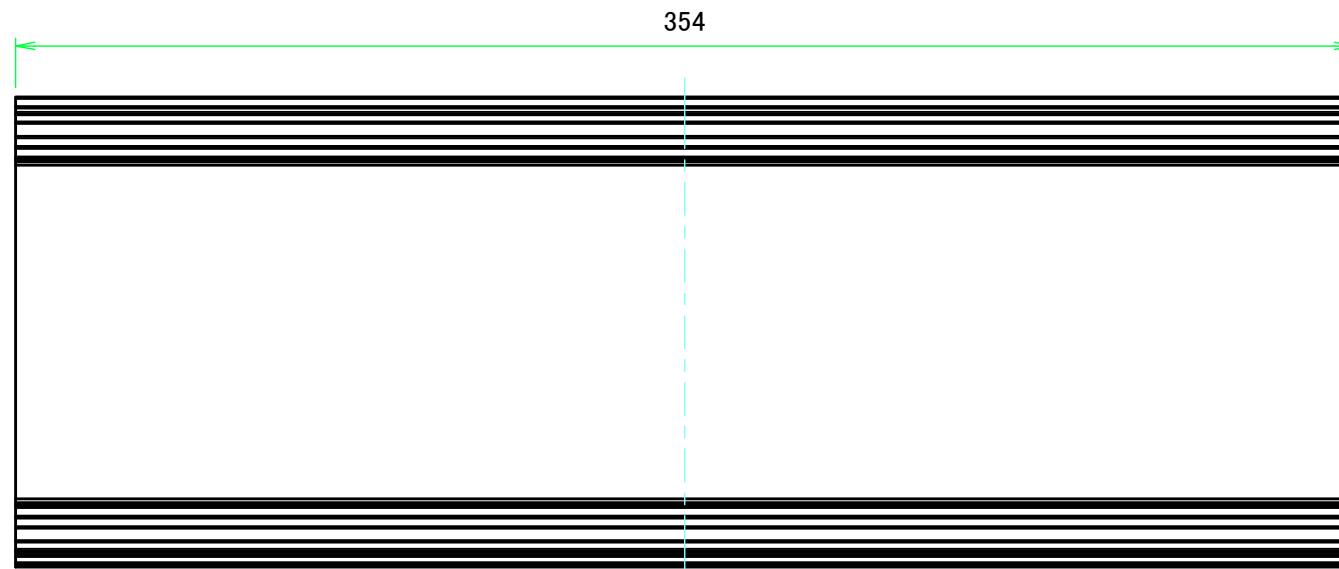
 株式会社タカチ電機工業 TAKACHI ELECTRONICS ENCLOSURE CO., LTD.		品名/Title フレーム2 Frame2	
承認/Approved	検図/Checked 大江	製図/Created 常山	型番/Product number H125.4 - W600
		作成日/Date 2017/08/31	尺度/Scale 1:2.5
			4 / 7



 株式会社タカチ電機工業 TAKACHI ELECTRONICS ENCLOSURE CO., LTD.			品名/Title	
			フレーム3 Frame3	
承認/Approved	検図/Checked	製図/Created	型番/Product number	尺度/Scale
	大江	常山	H125.4 - D400	1:2
			作成日/Date	5 / 7
			2017/08/31	

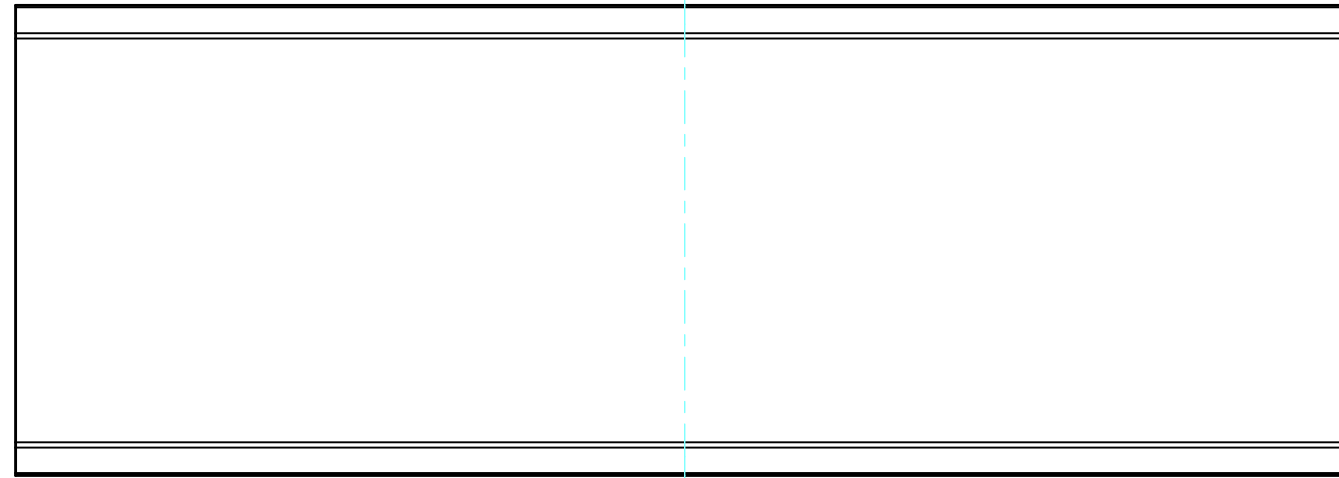
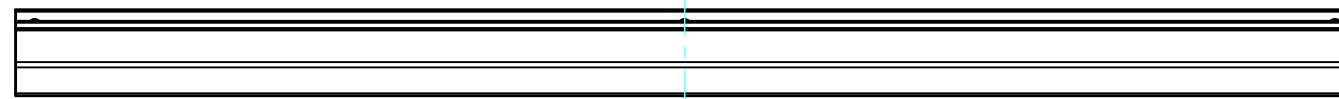
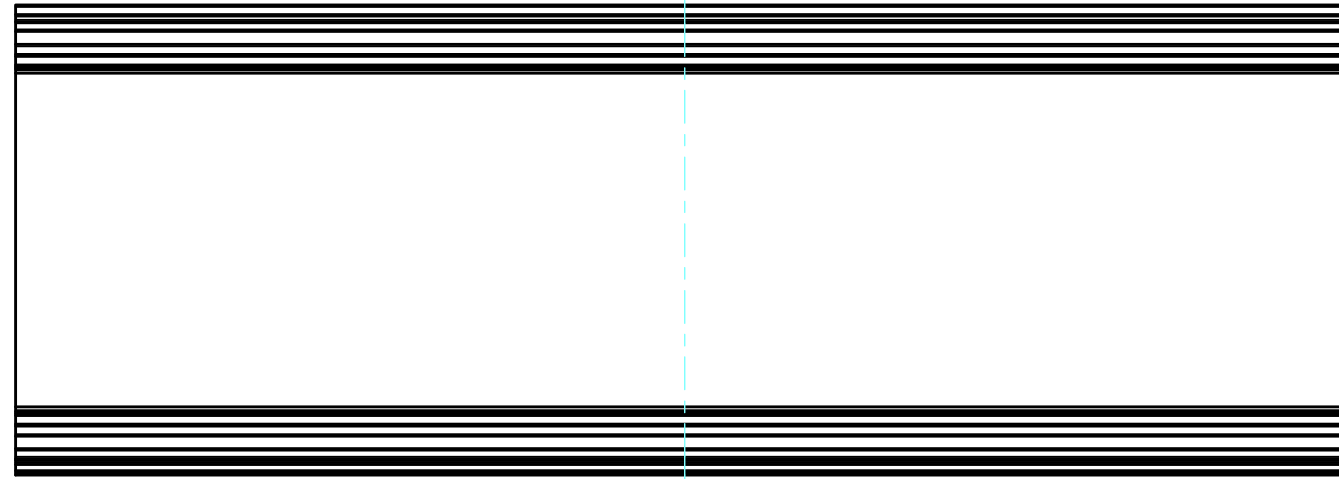

フレーム4 / Frame4

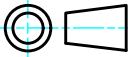
 株式会社タカチ電機工業 TAKACHI ELECTRONICS ENCLOSURE CO., LTD.			品名/Title フレーム4 Frame4	
承認/Approved	検図/Checked 大江	製図/Created 常山	型番/Product number H125.4 - D400	
			作成日/Date 2017/08/31	6 / 7

ハメ込みパネル / Slide panel

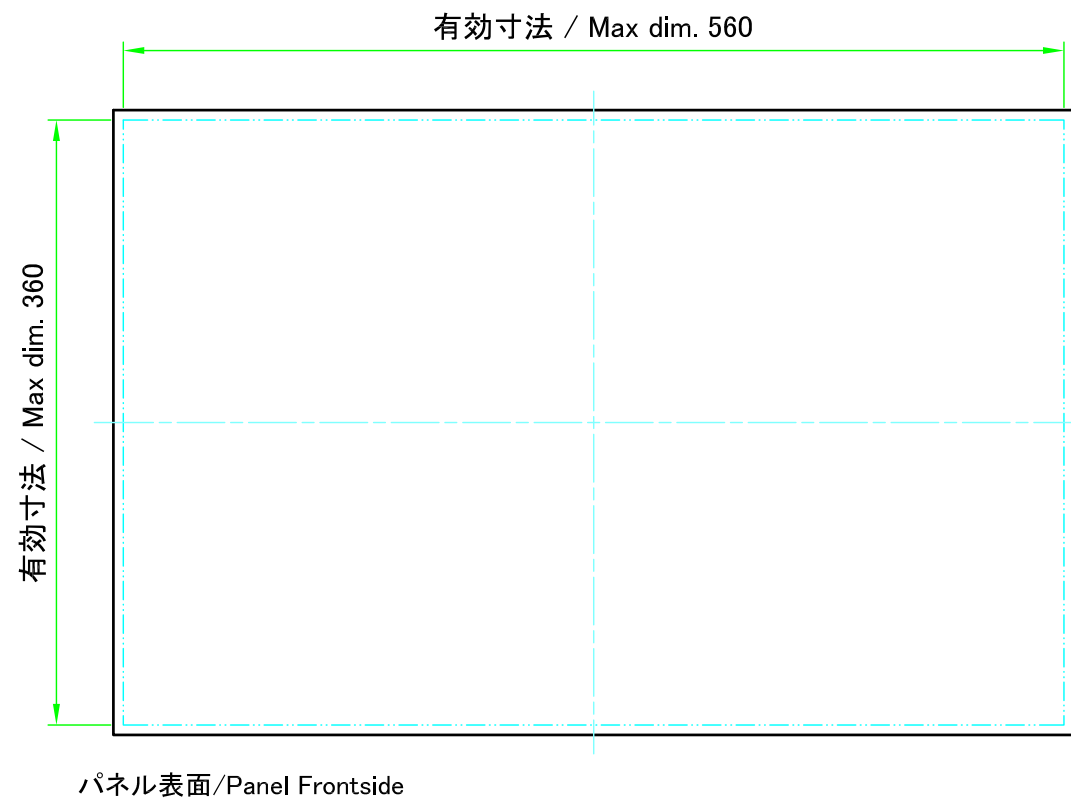

保護シート側
Surface protective film side

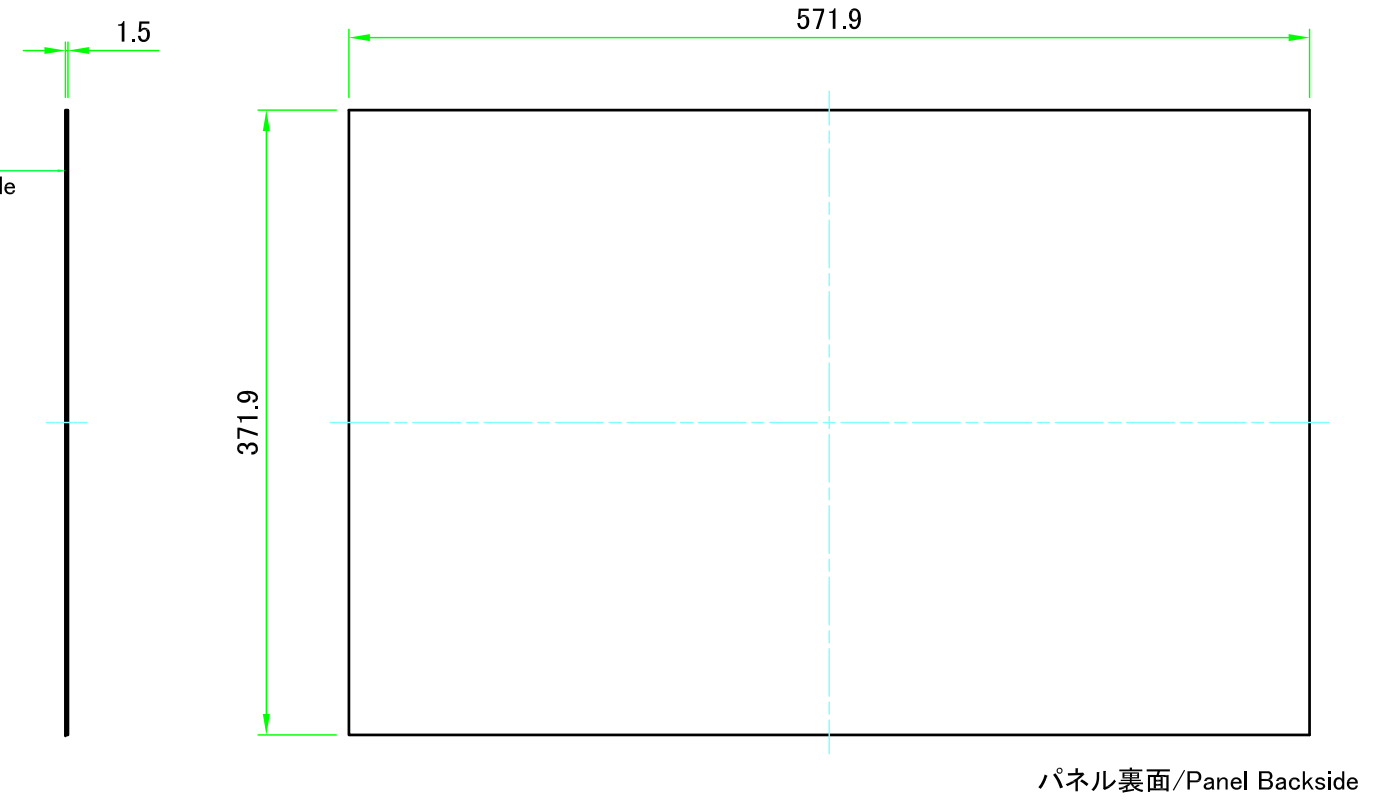

ねじ止めパネル / Screwed panel

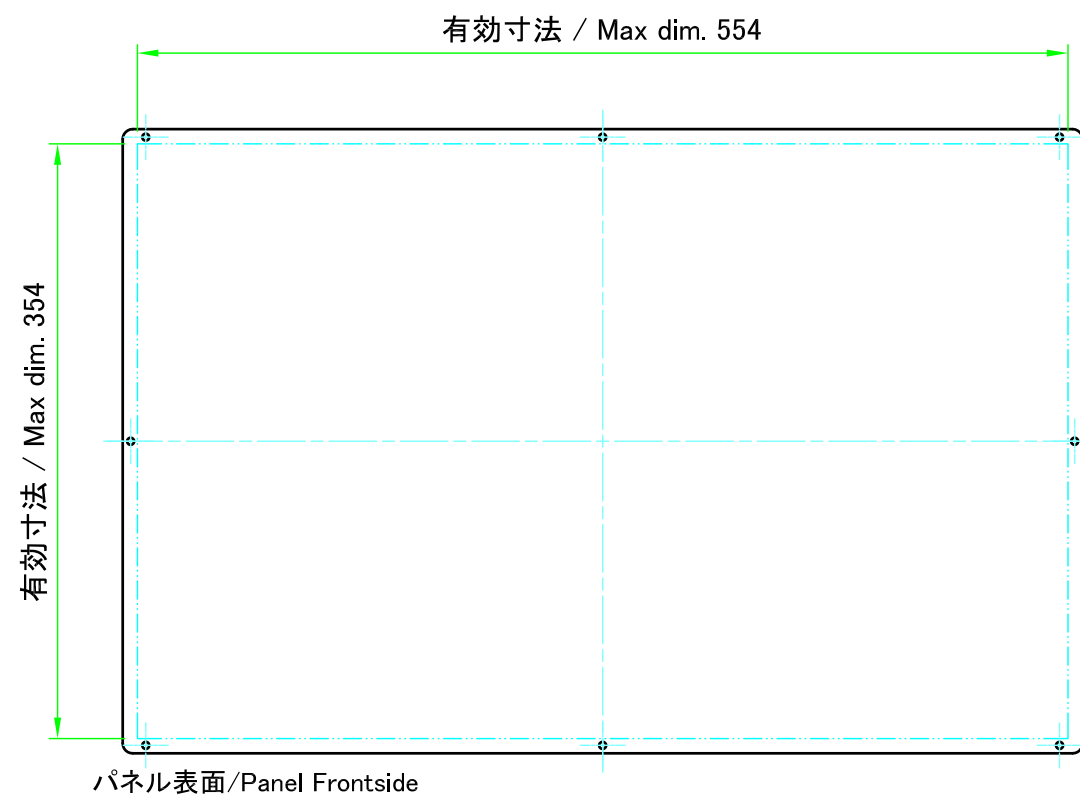

保護シート側
Surface protective film side

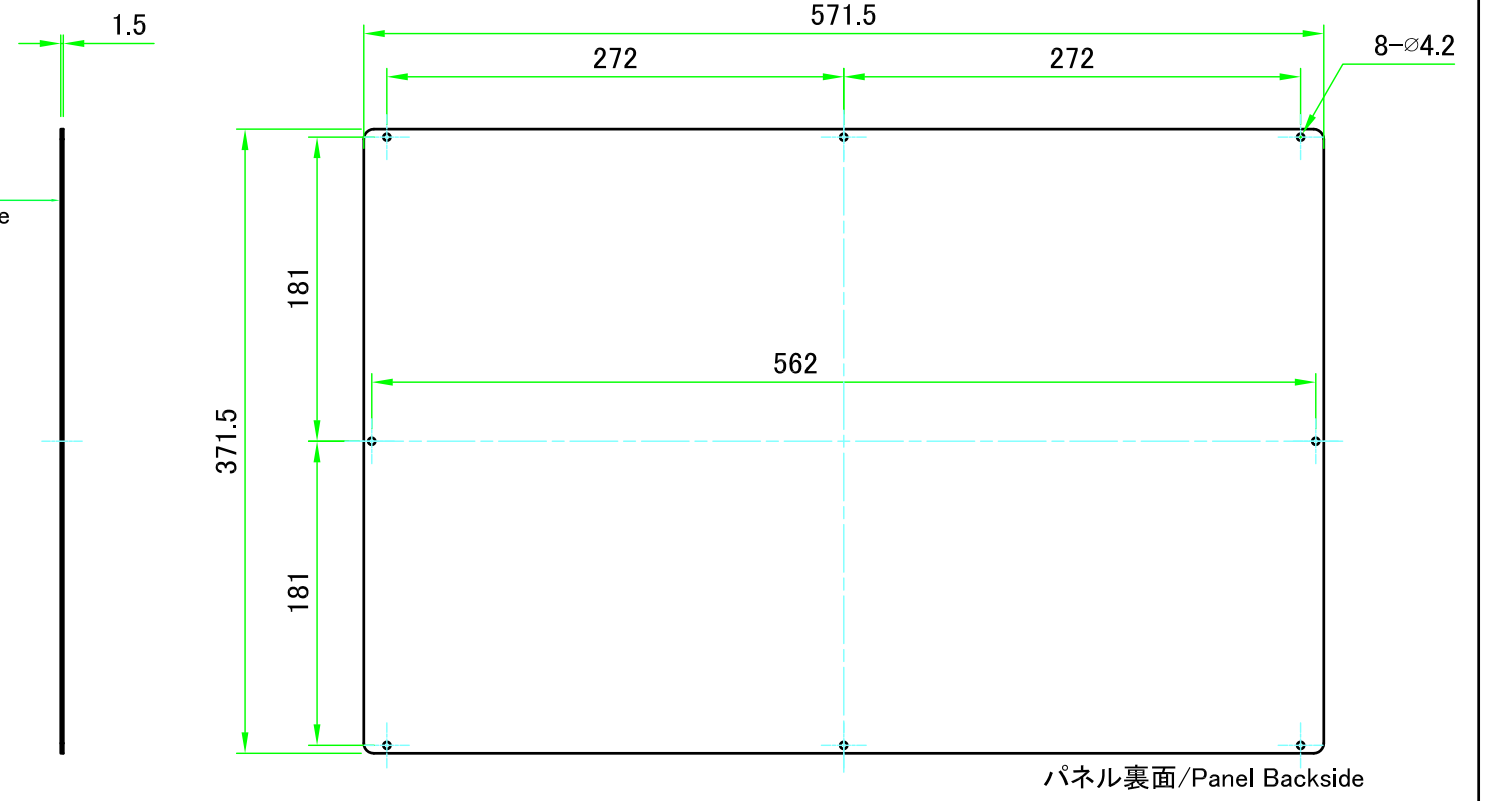

株式会社タカチ電機工業 TAKACHI ELECTRONICS ENCLOSURE CO., LTD.			品名/Title パネル Panel	尺度/Scale 1:4.5
承認/Approved	検図/Checked	製図/Created	型番/Product number W600 - D400	
中根	大江	常山	作成日/Date 2020/07/22	7 / 7