

※ゴム足寸法は含んでおりません。
 ※Rubber feet dimensions are not included.

構成内容 / Components				
No.	名称 / Part name	数量 / Pcs	材質 / Material	色・表面処理 / Color・Finish
1	パネル Panel	2	アルミ板 A1050P Aluminium A1050P	メタリックシルバー・表面塗装・裏面無処理 Metallic silver・Painted (Unfinished inside)
2	ヒートシンクカバー Heat-sink top cover	1	アルミ押出材 A6063S-T5 Extruded aluminium A6063S-T5	メタリックシルバー・表面塗装・裏面無処理 Metallic silver・Painted (Unfinished inside)
3	下カバー Bottom frame	1	アルミ押出材 A6063S-T5 Extruded aluminium A6063S-T5	メタリックシルバー・表面塗装・裏面無処理 Metallic silver・Painted (Unfinished inside)
4	フランジブラケット Flange bracket	2	アルミ押出材 A6063S-T5 Extruded aluminium A6063S-T5	メタリックシルバー・表面塗装・裏面無処理 Metallic silver・Painted (Unfinished inside)
5	シールドガスケット Fabric-over-foam gasket	2	導電性繊維・TPE Conductive fabric・TPE	メタリックグレー Metallic gray
6	取付ビス(六角穴付皿 M4×10) Screw (Hexagonal M4-10)	8	ステンレス Stainless steel	無処理 Unfinished
7	フランジ取付ビス / Flange screw	4	鉄 / Steel	三価黒クロメート / Black trivalent chromate
8	フランジ取付ナット / Flange nut	4	鉄 / Steel	三価黒クロメート / Black trivalent chromate
9	差込ゴム足 / Rubber feet	4	シリコンゴム / Silicone	ブラック / Black

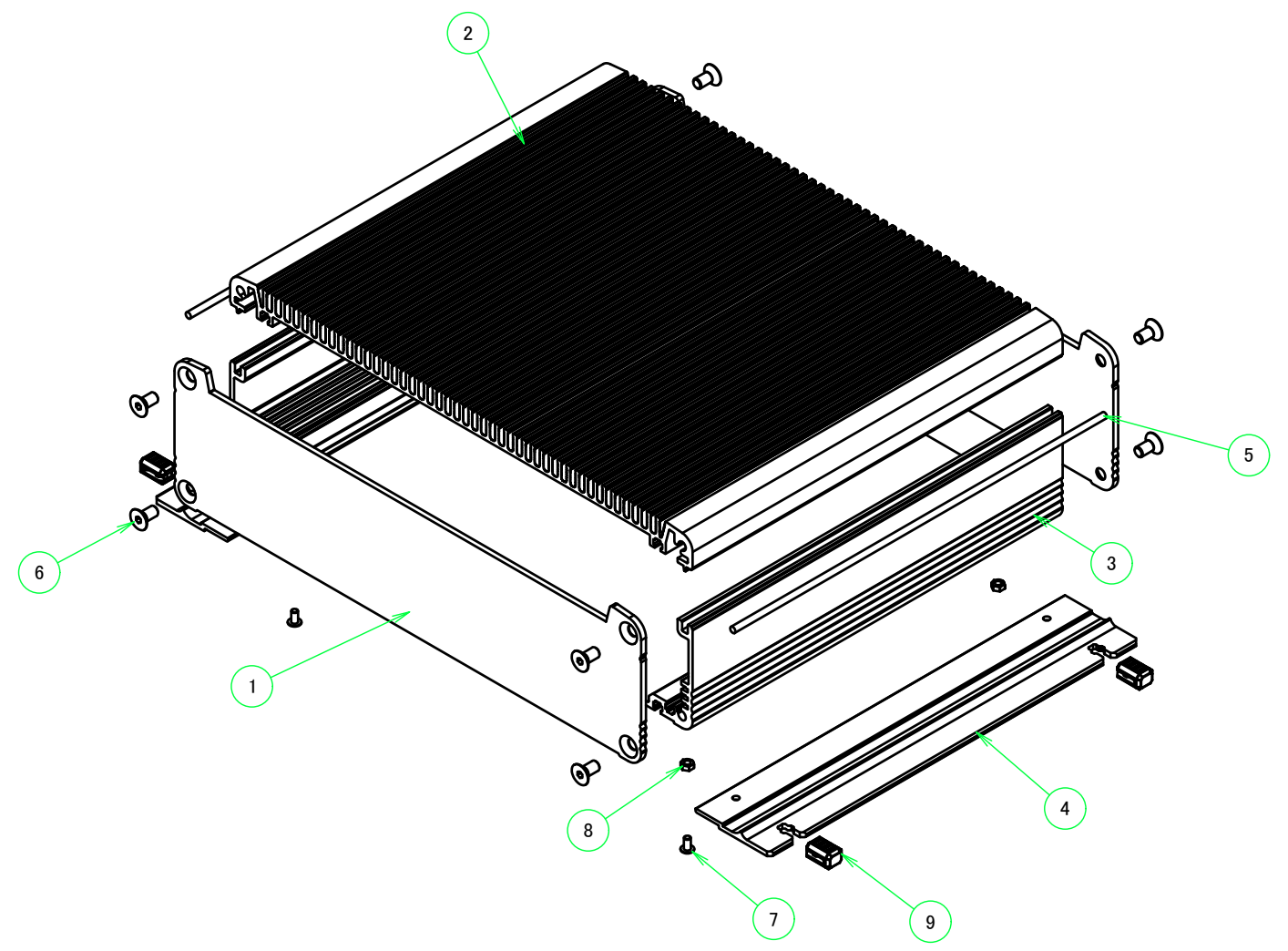

本図面および付帯する部品図の著作権は株式会社タカチ電機工業に帰属します。 / Copyright (C) TAKACHI ELECTRONICS ENCLOSURE CO., LTD. All Rights Reserved.

株式会社タカチ電機工業 TAKACHI ELECTRONICS ENCLOSURE CO., LTD.		品名/Title フランジ足付ヒートシンクアルミケース FLANGED HEAT-SINK ALUMINIUM EMC SHIELD ENCLOSURE	尺度/Scale 1 : 3	
承認/Approved	検図/Checked	製図/Created		型番/Product number EXHF29-8-23SS
中根	野村	岡本	作成日/Date 2022/12/30	1 / 6

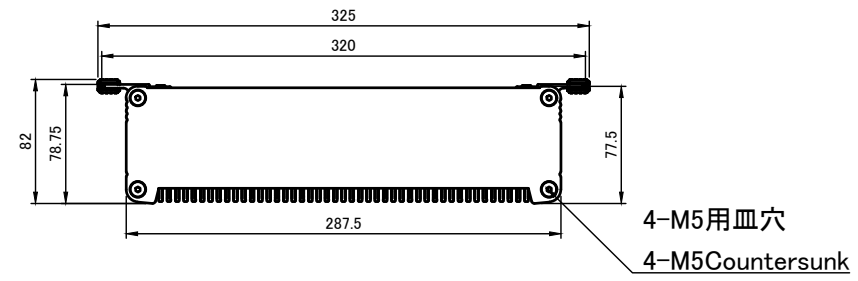

4-M5用皿穴
4-M5 Countersunk

差込ゴム足
Rubber feet

B-B (1:5)

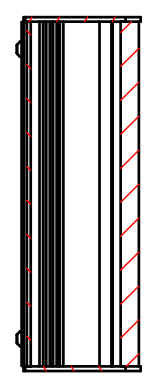

C C D D

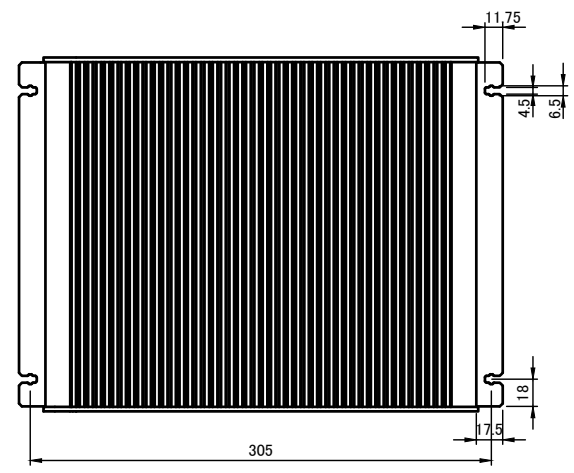
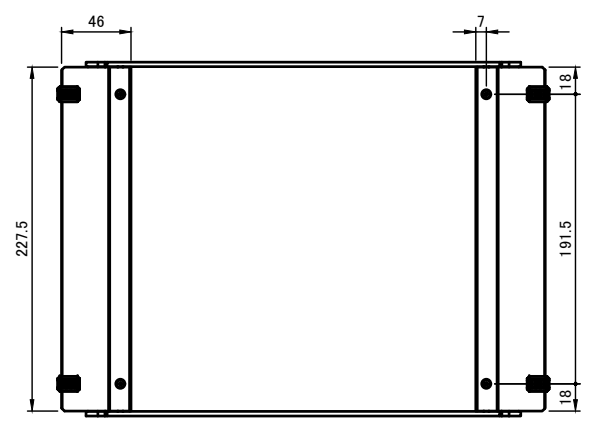
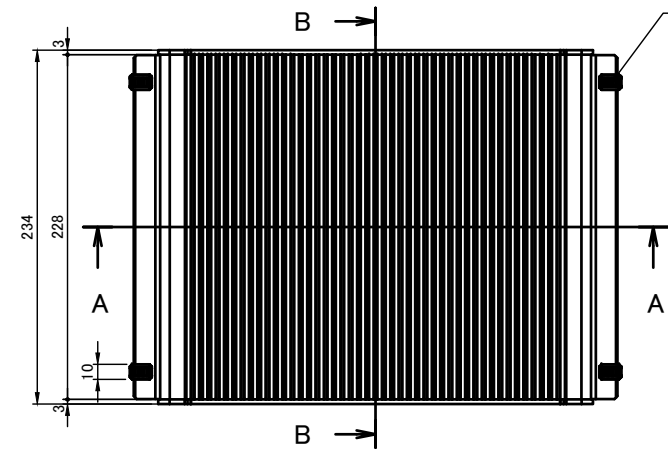
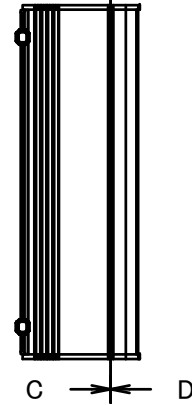

C-C (1:5)

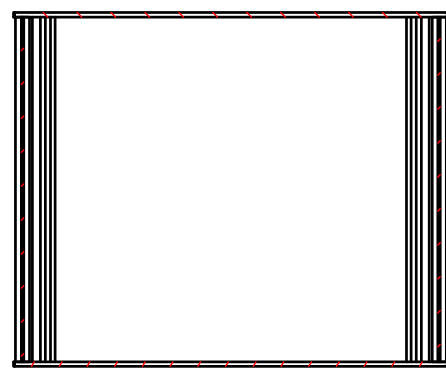

D-D (1:5)

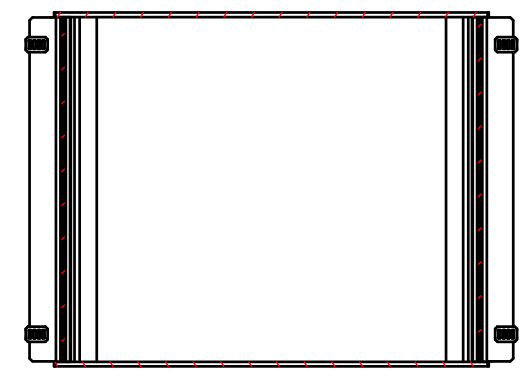

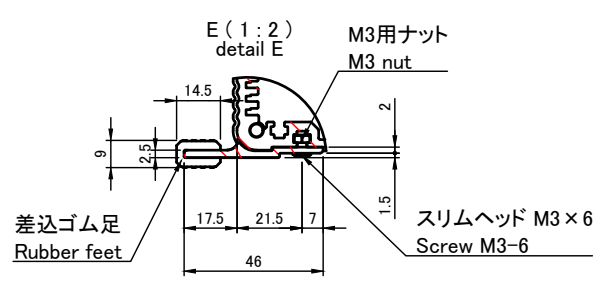
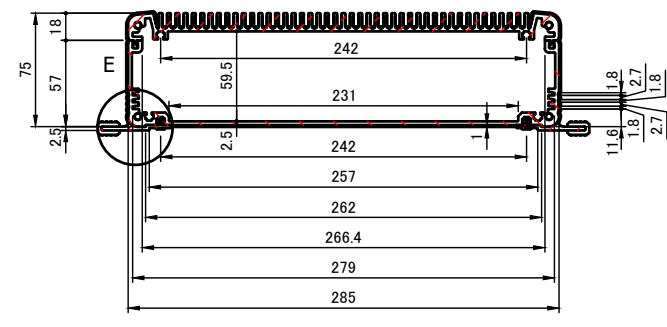

A-A (1:5)



株式会社タカチ電機工業 <small>TAKACHI ELECTRONICS ENCLOSURE CO., LTD.</small>		品名/Title フランジ足付ヒートシンクアルミケース FLANGED HEAT-SINK ALUMINIUM EMC SHIELD ENCLOSURE	尺度/Scale 1:5
承認/Approved 中根	検図/Checked 野村	製図/Created 岡本	
作成日/Date 2022/06/30			2 / 6

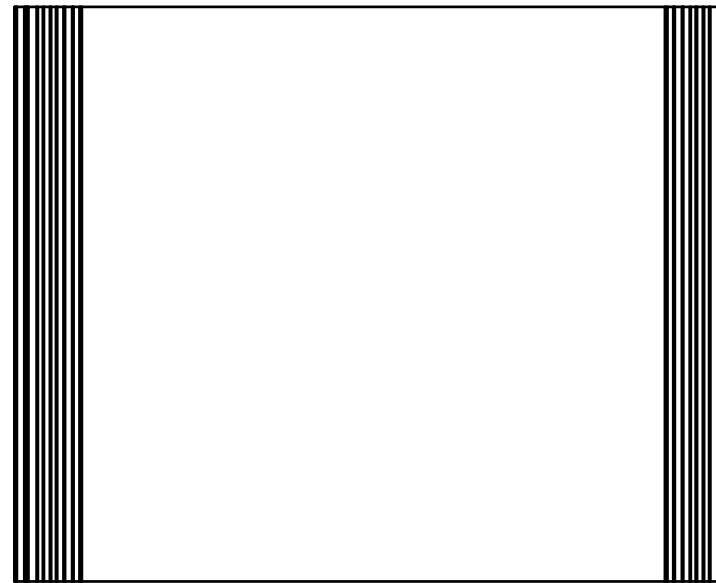
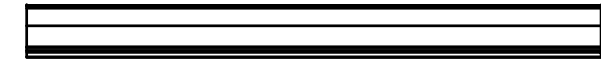
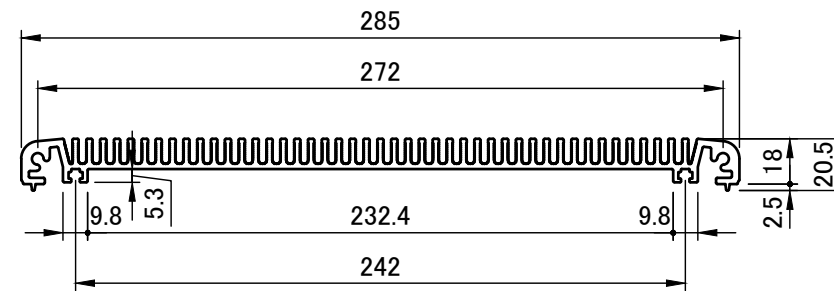
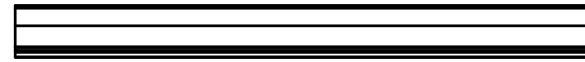
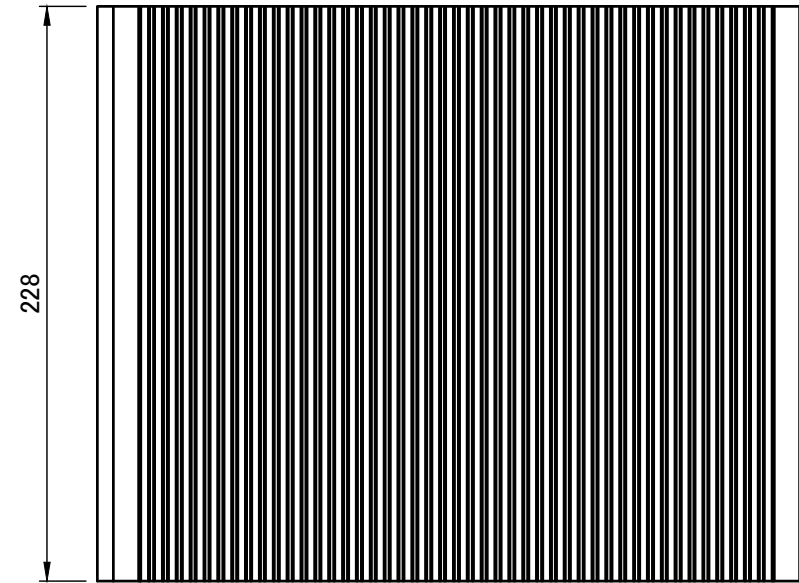

ヒートシンク / Heat-sink top cover

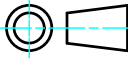

 株式会社タカチ電機工業 TAKACHI ELECTRONICS ENCLOSURE CO., LTD.		品名/Title ヒートシンクカバー HEAT-SINK TOP COVER	 尺度/Scale 1 : 3
承認/Approved 中根	検図/Checked 野村	製図/Created 岡本	
型番/Product number W285-D228			3 / 6
作成日/Date 2022/06/30			

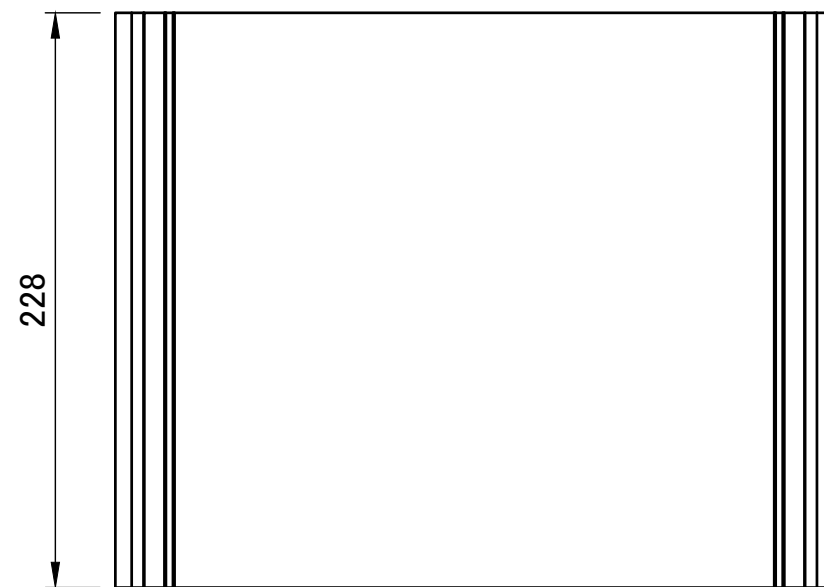
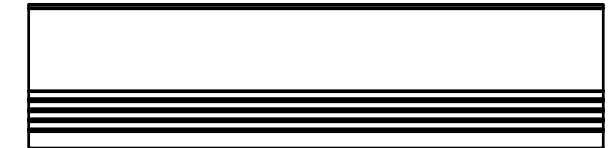
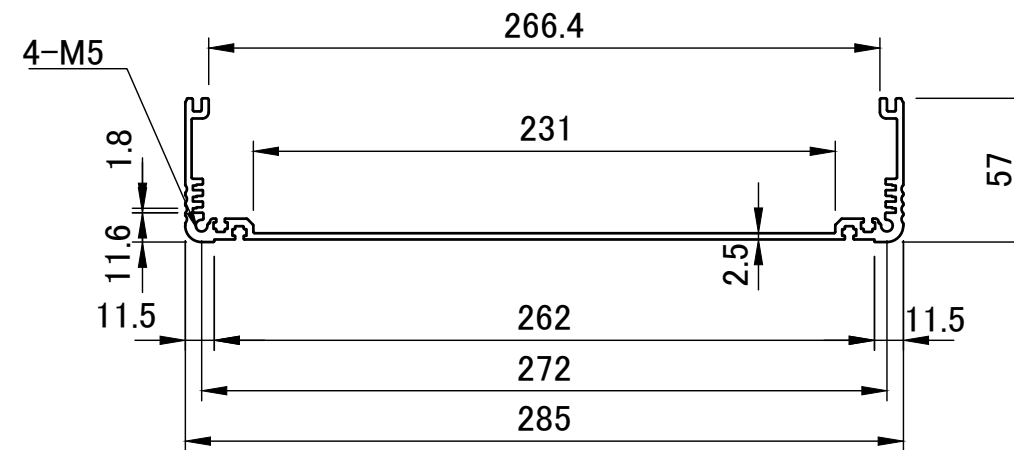
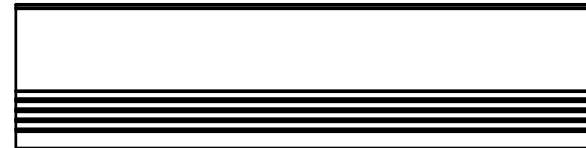
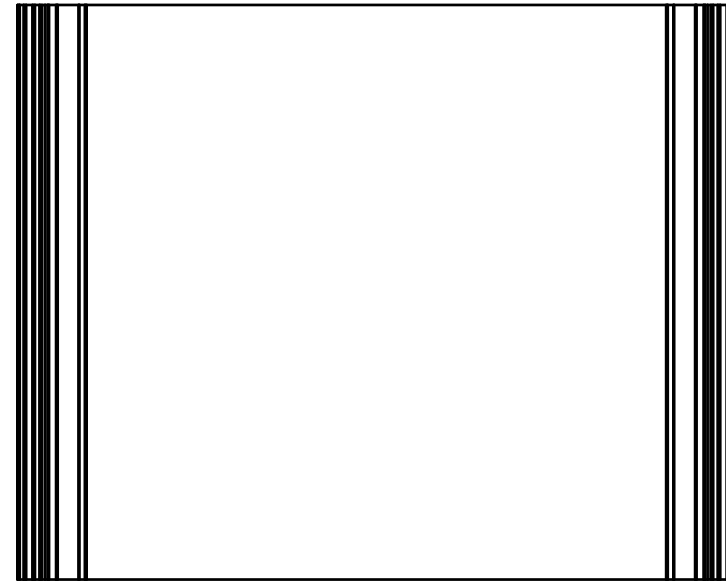
下カバー / Bottom frame



 株式会社タカチ電機工業 TAKACHI ELECTRONICS ENCLOSURE CO., LTD.			品名/Title 下カバー BOTTOM FRAME	 尺度/Scale 1:3
承認/Approved	検図/Checked	製図/Created	型番/Product number W285-H75-D228	
中根	岡本	大江	作成日/Date 2022/06/30	4 / 6

パネル / End panel

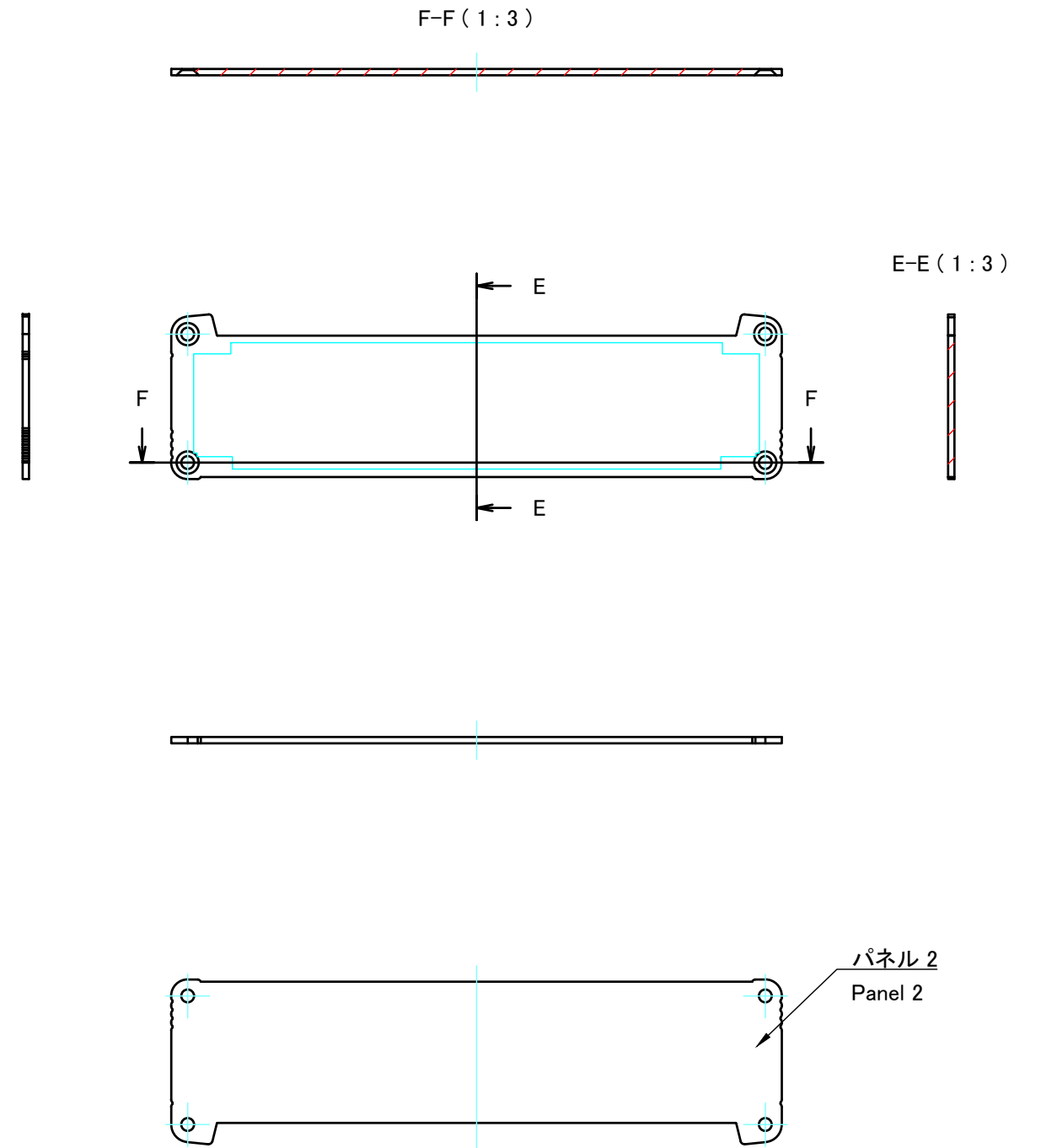
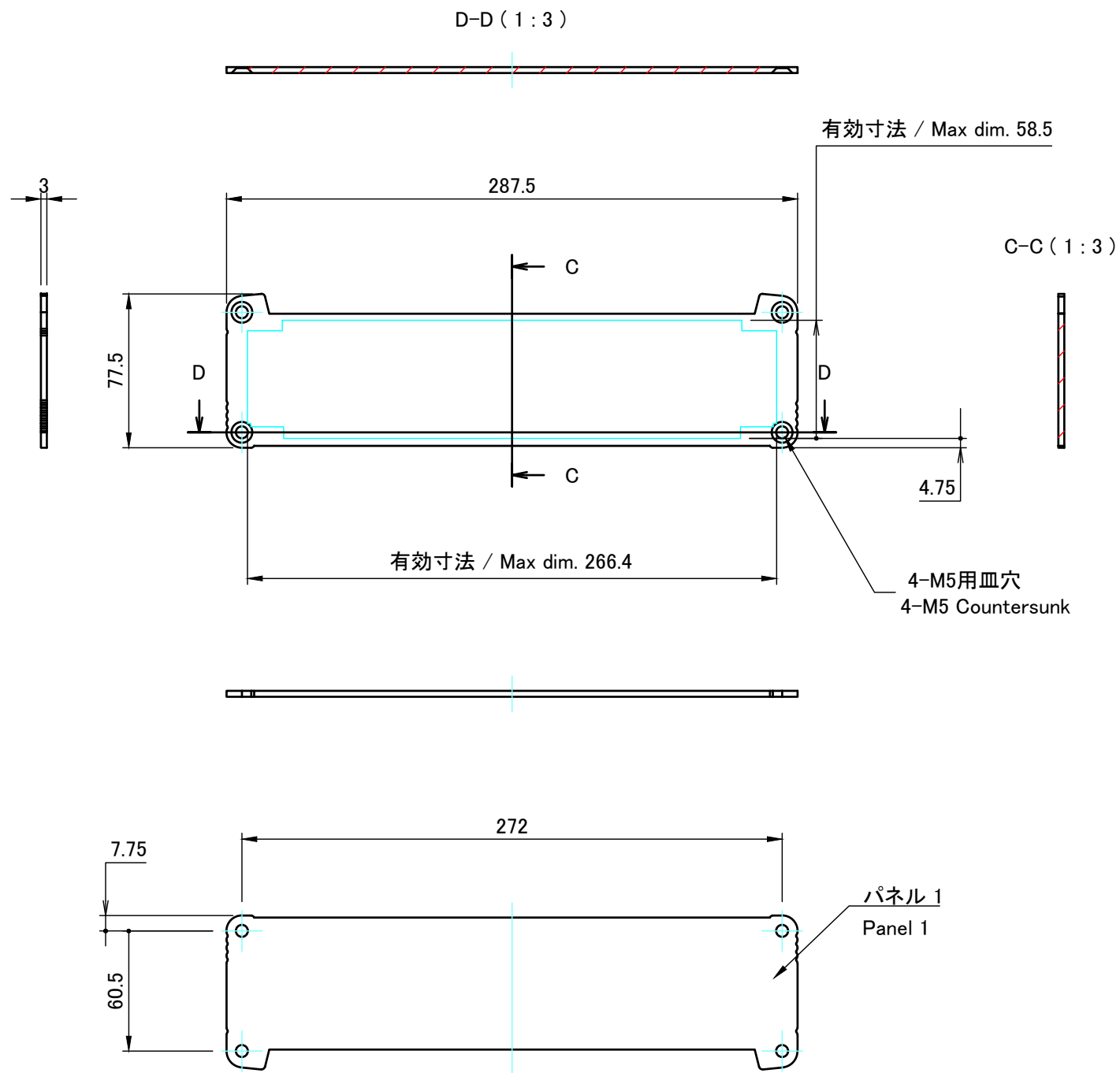

株式会社タカチ電機工業 TAKACHI ELECTRONICS ENCLOSURE CO., LTD.			品名/Title パネル END PANEL	尺度/Scale 1 : 3
承認/Approved	検図/Checked	製図/Created	型番/Product number W287.5-H77.5	
中根	野村	岡本	作成日/Date 2023/02/15	5 / 6

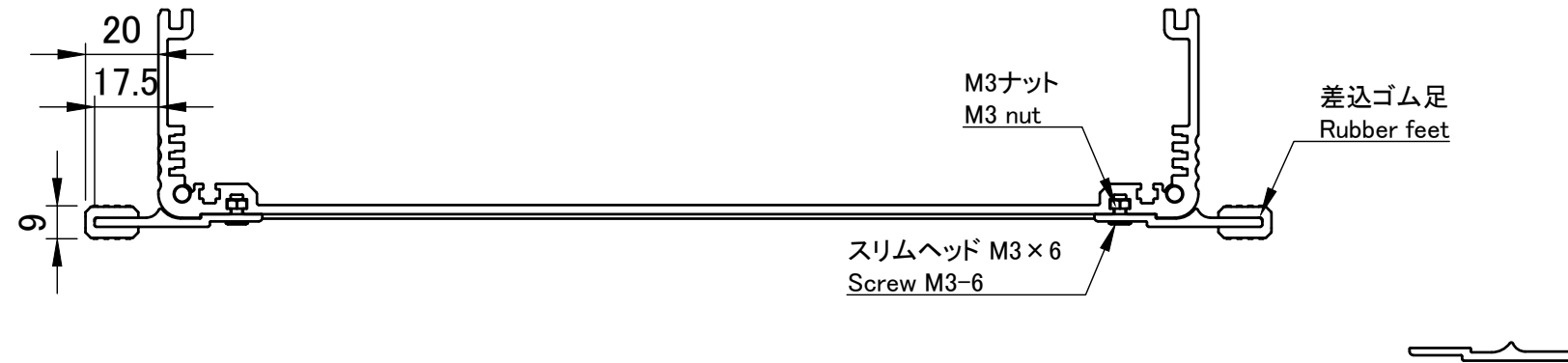
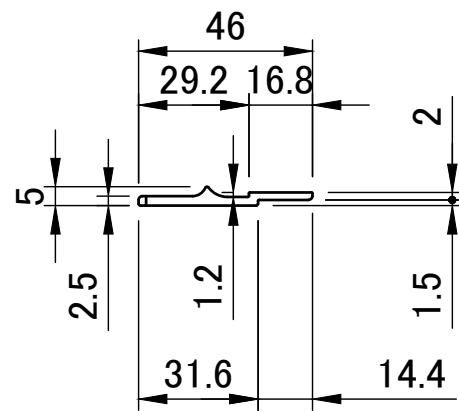
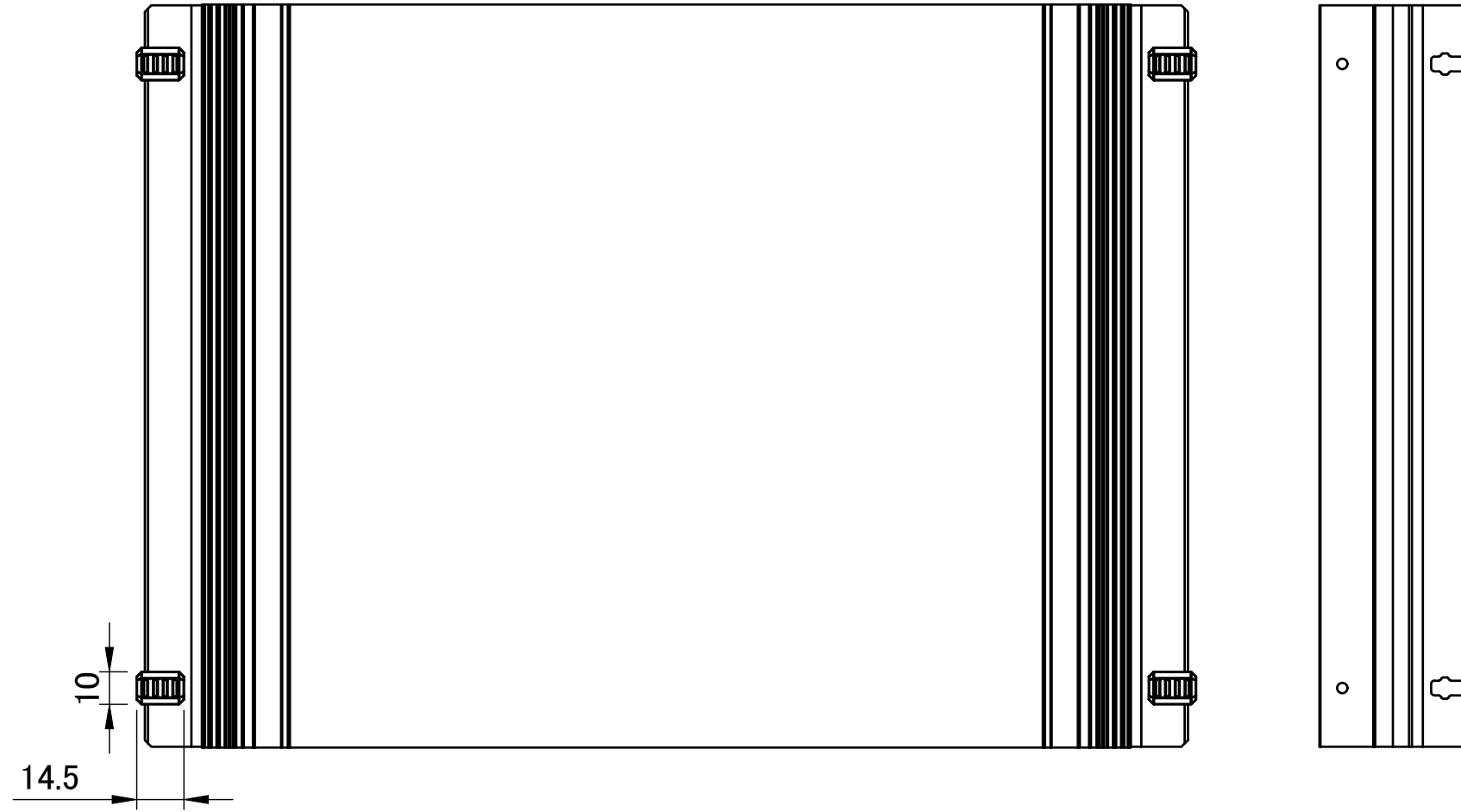
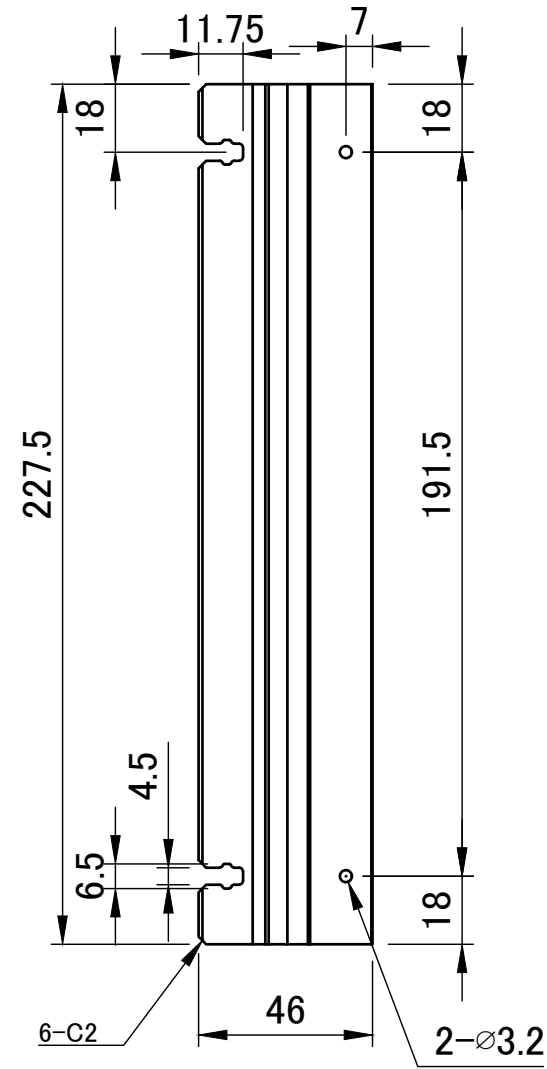

株式会社タカチ電機工業 TAKACHI ELECTRONICS ENCLOSURE CO., LTD.			品名/Title フランジブラケット Flange bracket	尺度/Scale 1:2
承認/Approved	検図/Checked	製図/Created	型番/Product number EXHF29-0-23	
中根	野村	岡本	作成日/Date 2022/06/30	6 / 6