

| 構成内容 / Components | | | | |
|-------------------|----------------------------------|----------|--|---|
| No. | 名称 / Part name | 数量 / Pcs | 材質 / Material | 色・表面処理 / Color・Finish |
| 1 | パネル Panel | 2 | アルミ板 A1050P Aluminium A1050P | メタリックシルバー・表面塗装-内面無処理,ブラックアルマイト Silver・Painted(outside)-Unfinished(inside),black Anodized |
| 2 | ヒートシンクカバー Heat-sink top cover | 1 | アルミ押出材 Extruded aluminium A6063S-T5 | メタリックシルバー・表面塗装-内面無処理,ブラックアルマイト Silver・Painted(outside)-Unfinished(inside),black Anodized |
| 3 | 下カバー Bottom frame | 1 | アルミ押出材 Extruded aluminium A6063S-T5 | メタリックシルバー・表面塗装-内面無処理,ブラックアルマイト Silver・Painted(outside)-Unfinished(inside),black Anodized |
| 4 | 取付ビス(M5×10皿六角穴付) / Screw | 8 | ステンレス / Stainless steel | 無処理 / Unfinished |
| 5 | ゴム足 / Rubber feet | 4 | 合成ゴム / Rubber | ブラック / Black |

※ゴム足は任意の場所に貼り付けできます。
※Adhesive rubber feet included.

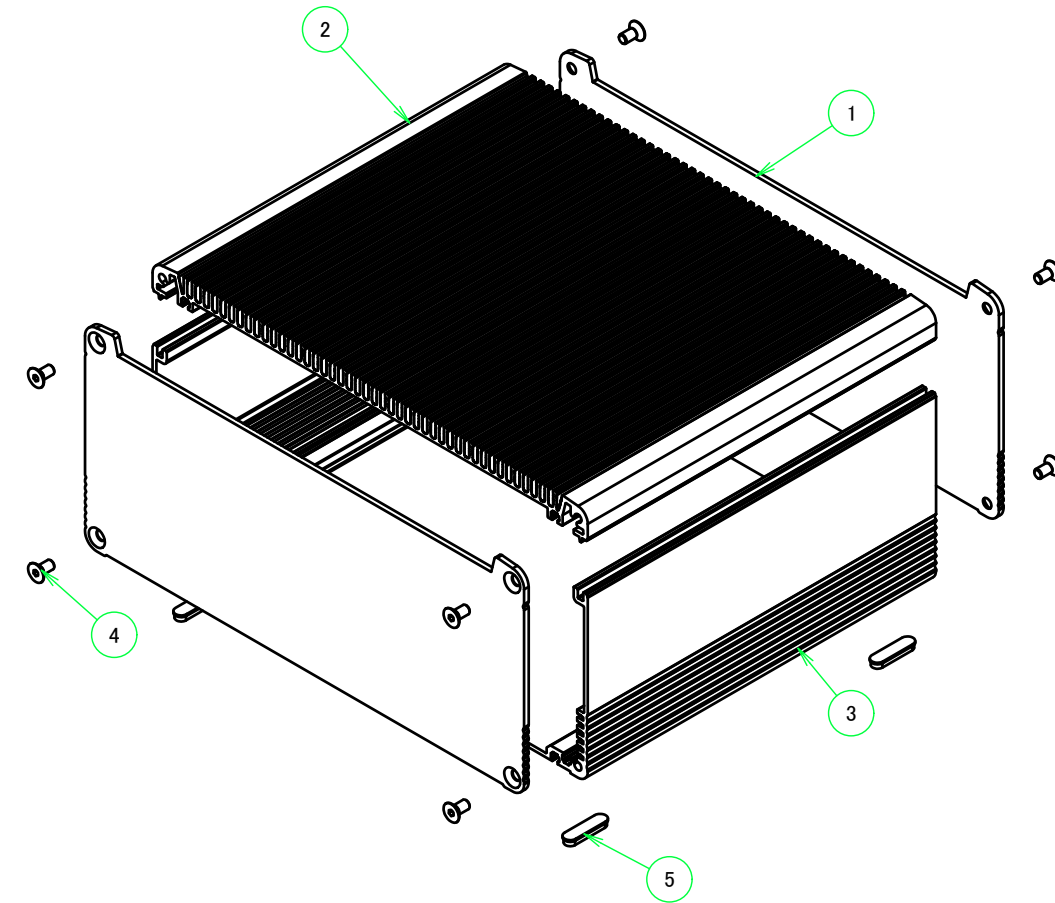
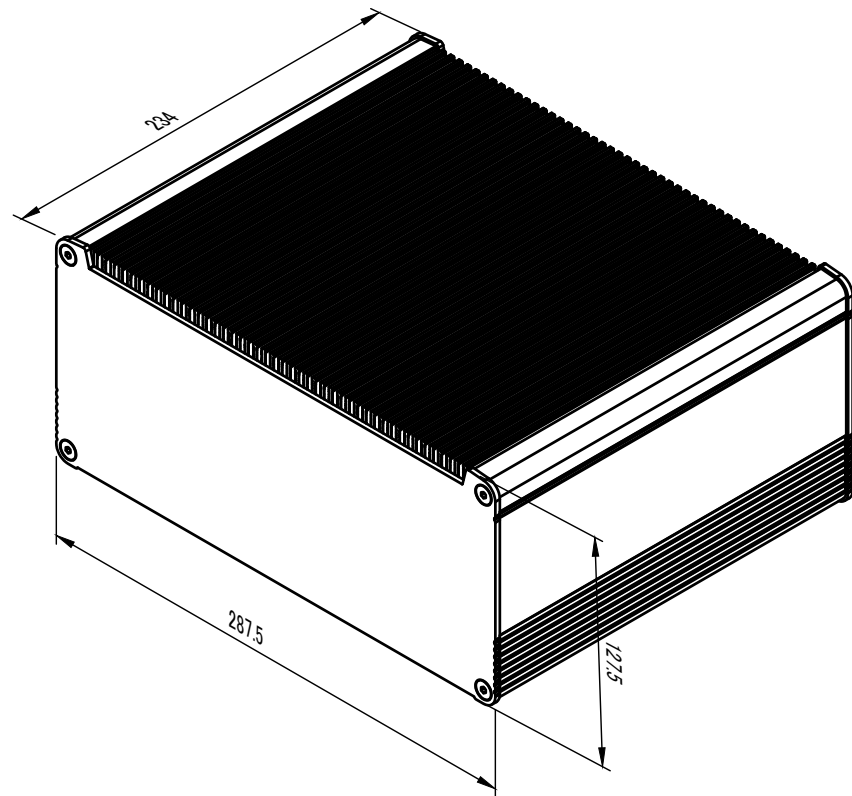

本図面および付帯する部品図の著作権は株式会社タカチ電機工業に帰属します。 / Copyright (C) TAKACHI ELECTRONICS ENCLOSURE CO., LTD. All Rights Reserved.

| 色仕様(型番末尾口)/Color type | | |
|-----------------------|-------------------|-------------|
| 記号/Code | ヒートシンク・下カバー/Cover | パネル/Panel |
| SS | シルバー/Silver | シルバー/Silver |
| BB | ブラック/Black | ブラック/Black |

| | | | |
|---|------------------|--|---------------------|
| TAKACHI 株式会社タカチ電機工業 TAKACHI ELECTRONICS ENCLOSURE CO., LTD. | | 品名/Title ヒートシンクアルミケース HEAT-SINK ALUMINIUM CASE | |
| 承認/Approved 中根 | 検図/Checked 大江 | 製図/Created 岡本 | 尺度/Scale 1 : 3.5 |
| 型番/Product number EXH29-13-23□□ | | | 1 / 5 |
| 作成日/Date 2022/11/30 | | | |

ゴム足

Rubber feet

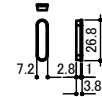

4-M5皿ビス
4-M5Countersunk

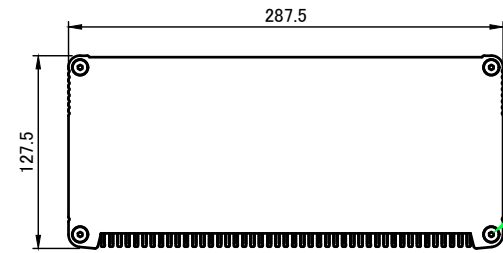

B-B (1:5)

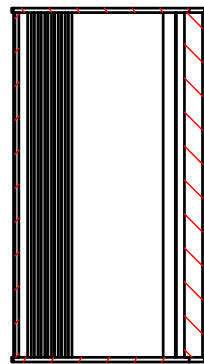

C D

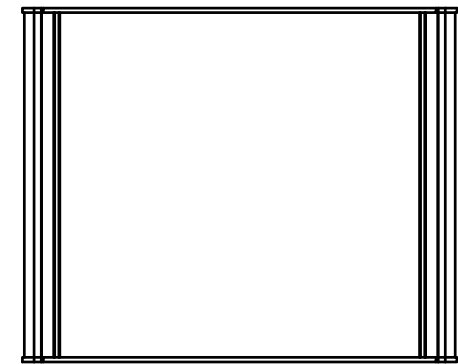
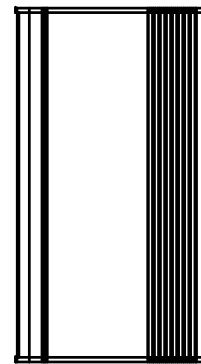
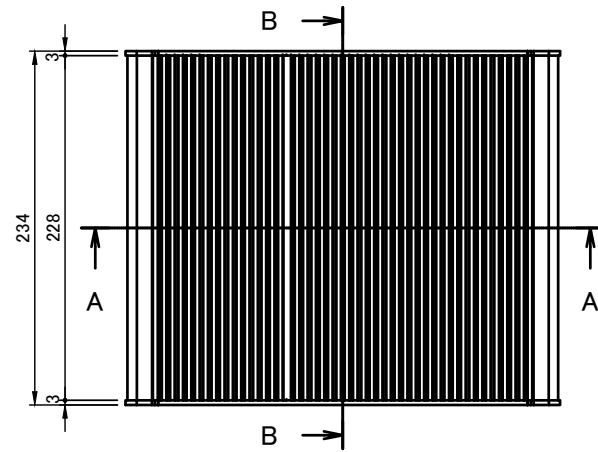
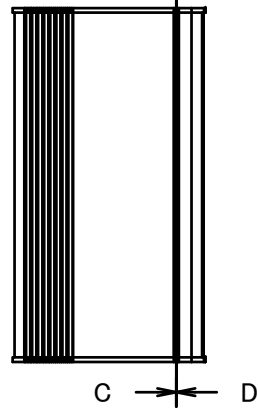

C-C (1:5)

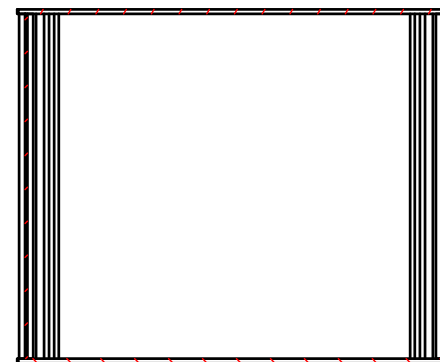

D-D (1:5)

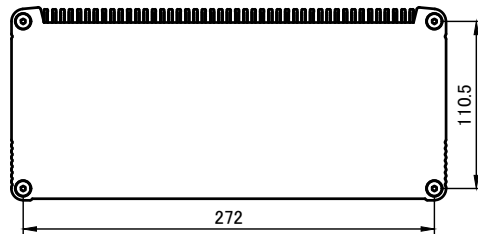
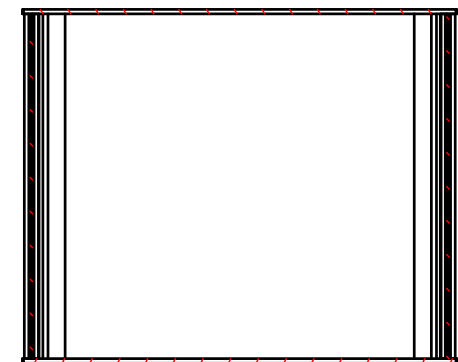

A-A (1:5)

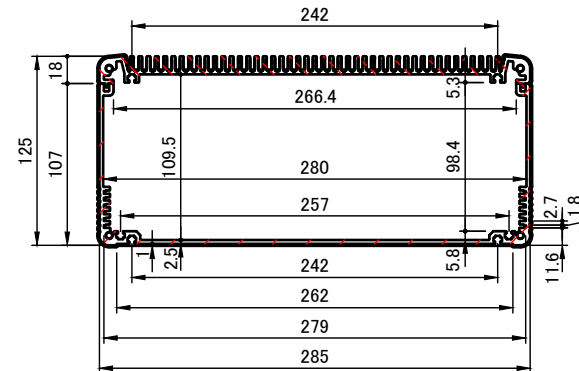

| | | | | |
|--|------------|------------|--|-----------------|
| 株式会社タカチ電機工業 TAKACHI ELECTRONICS ENCLOSURE CO., LTD. | | | 品名/Title ヒートシンクアルミケース SINK ALUMINIUM ENCLOSURE | 尺度/Scale 1:5 |
| 承認/Approved | 検図/Checked | 製図/Created | 型番/Product number EXH29-13-23□□ | |
| 中根 | 大江 | 岡本 | 作成日/Date 2022/04/06 | 2 / 5 |

ヒートシンク / Heat-sink top cover

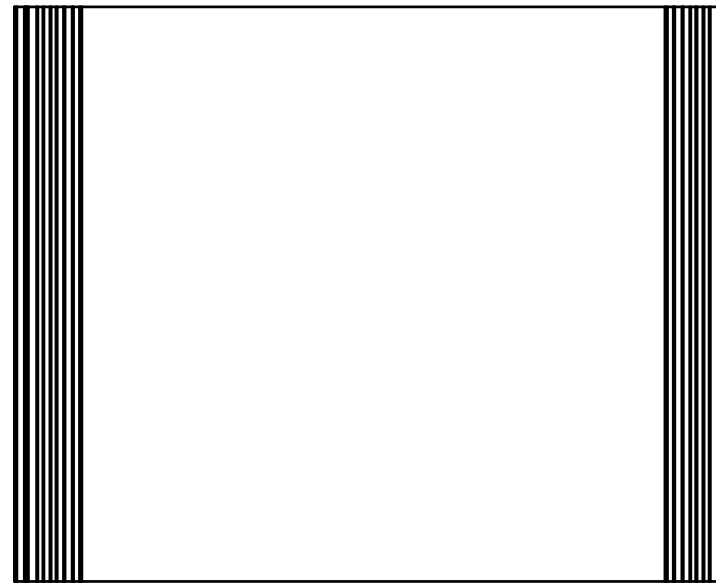
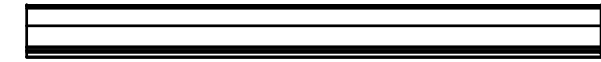
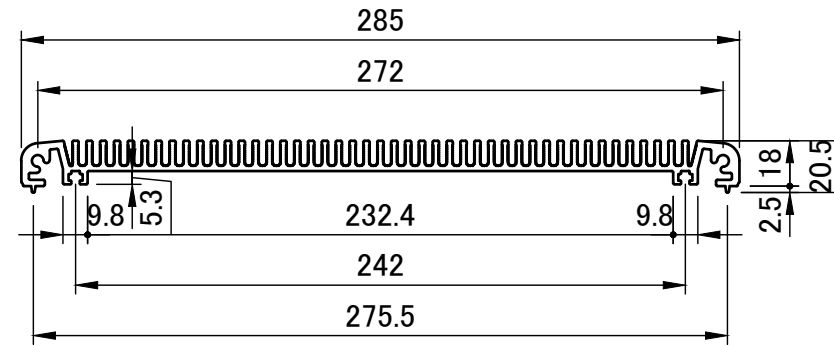
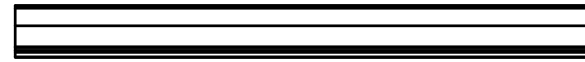
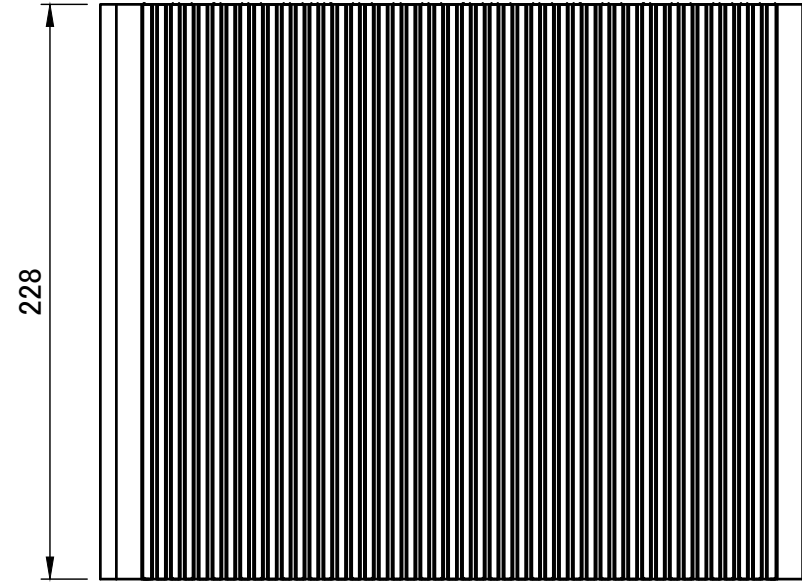

| | | | |
|--|------------|---|---|
|  株式会社タカチ電機工業 TAKACHI ELECTRONICS ENCLOSURE CO., LTD. | | 品名/Title ヒートシンクアルミケース HEAT-SINK ALUMINIUM ENCLOSURE |  |
| 承認/Approved | 検図/Checked | 製図/Created | 型番/Product number EXH29-□-23□□ |
| 中根 | 大江 | 岡本 | 作成日/Date 2022/03/30 |
| | | | 尺度/Scale 1 : 3 |
| | | | 3 / 5 |

下カバー / Bottom frame

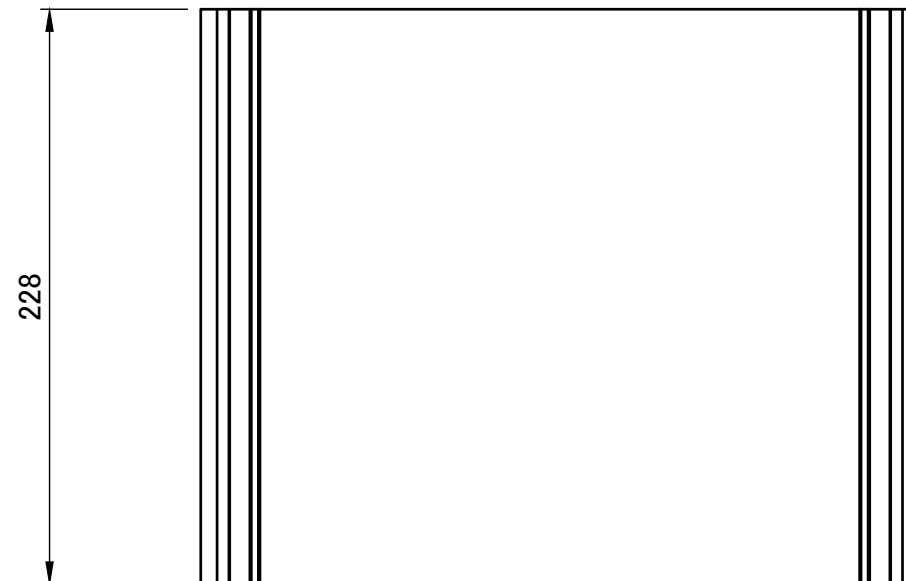
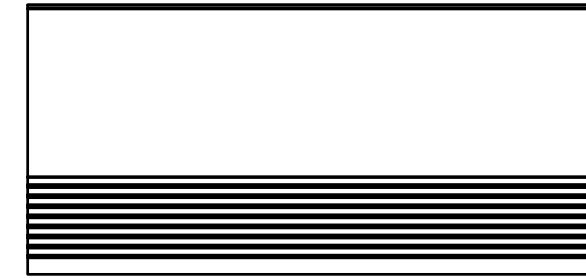
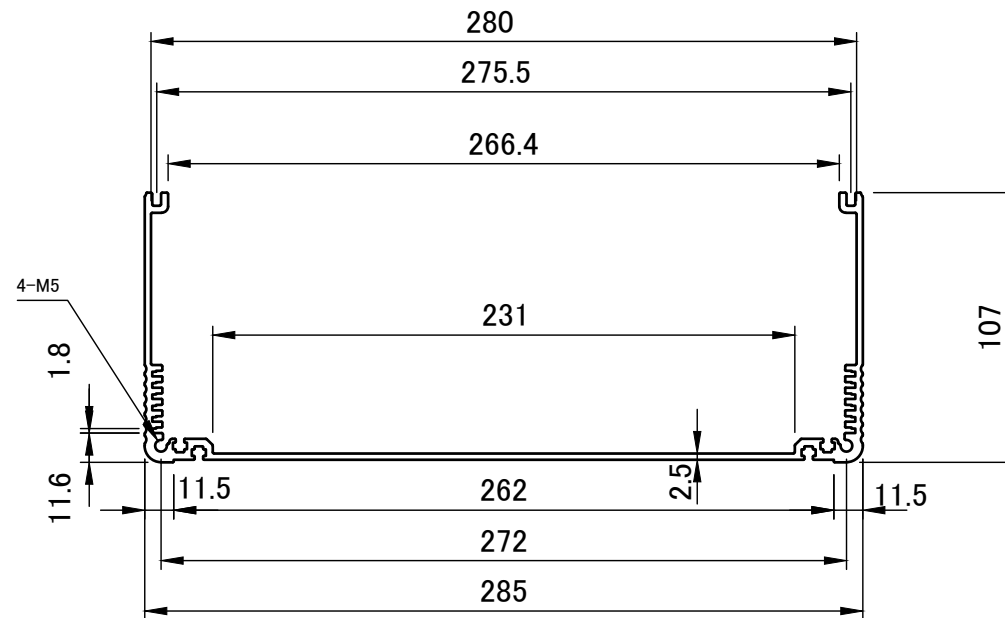
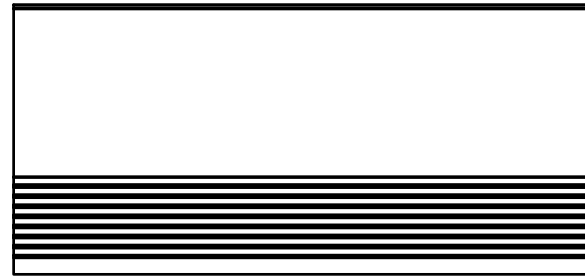
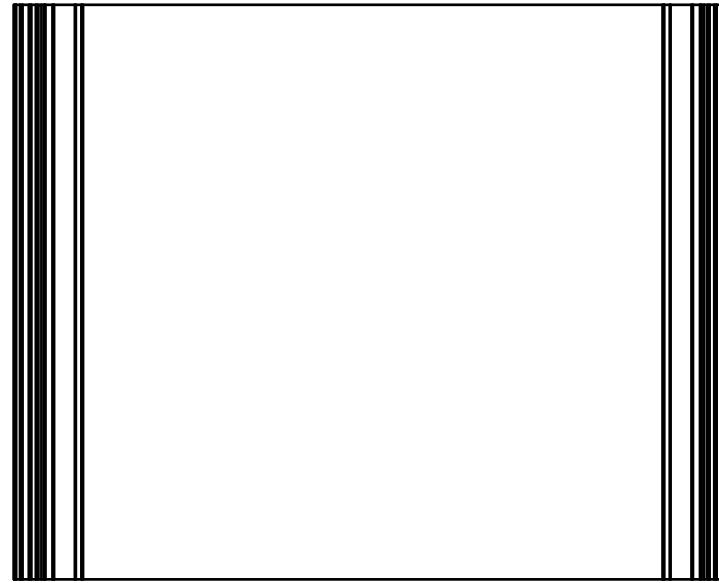

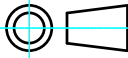
| | | | |
|--|------------|----------------------------------|---|
|  株式会社タカチ電機工業 TAKACHI ELECTRONICS ENCLOSURE CO., LTD. | | 品名/Title 下カバー BOTTOM COVER |  尺度/Scale 1:3 |
| 承認/Approved | 検図/Checked | 製図/Created | |
| 中根 | 岡本 | 大江 | 作成日/Date 2021/07/13 |
| | | | 4 / 5 |

パネル / Panel

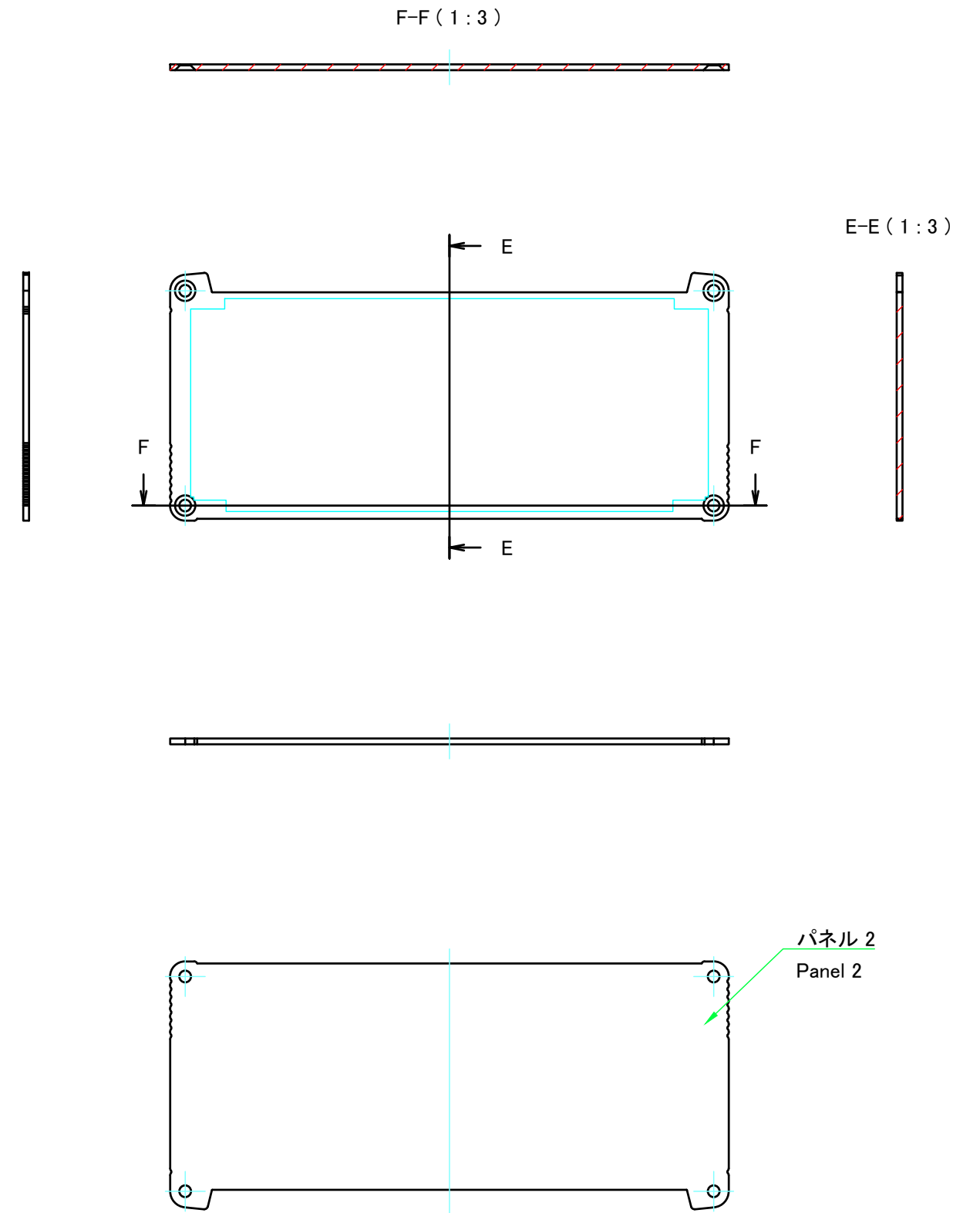
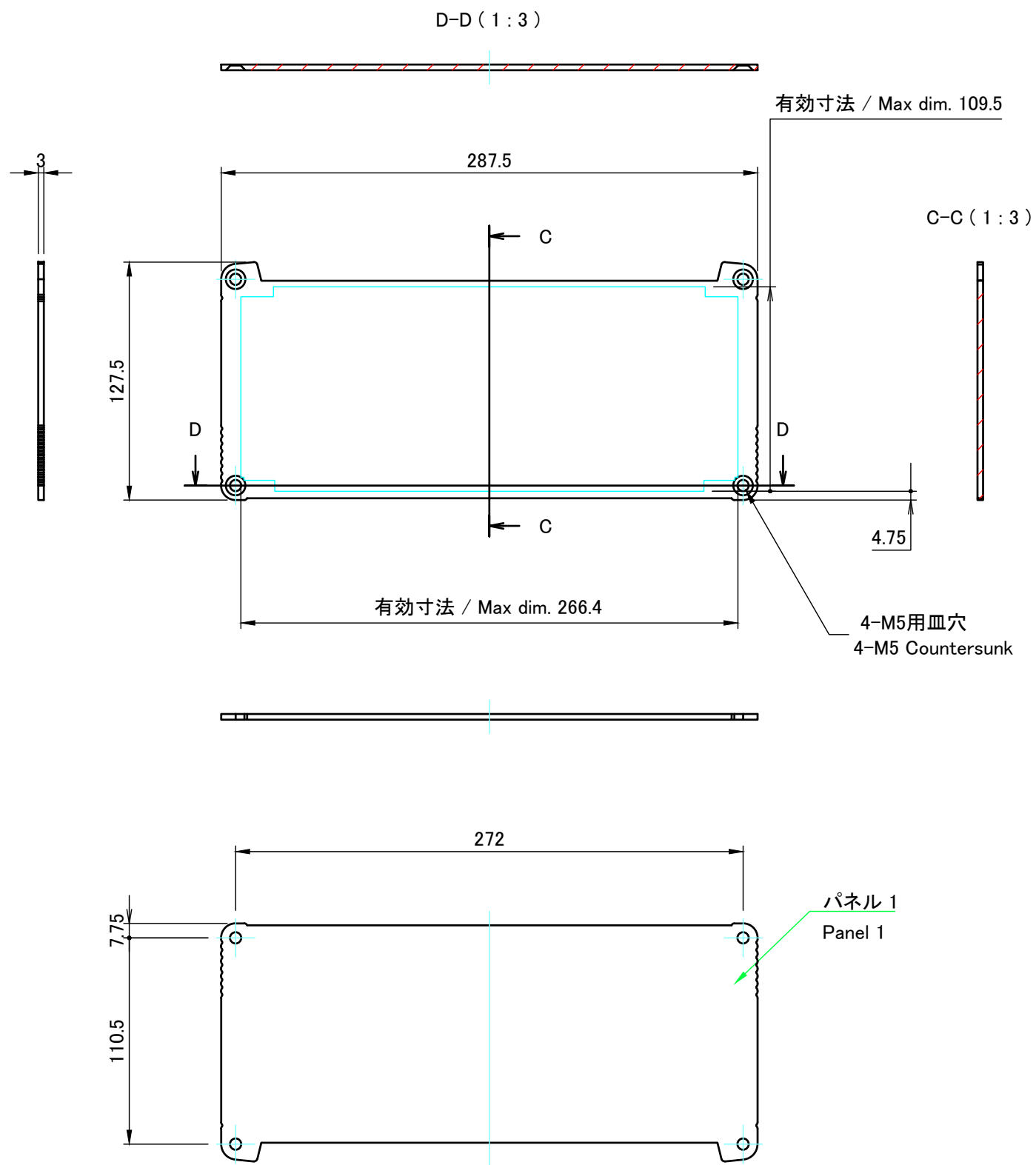

| | | | | |
|---|------------|------------|---|-----------------|
| 株式会社タカチ電機工業 TAKACHI ELECTRONICS ENCLOSURE CO., LTD. | | | 品名/Title パネル PANEL | 尺度/Scale 1:3 |
| 承認/Approved | 検図/Checked | 製図/Created | 型番/Product number W287.5 - H127.5 | |
| 中根 | 岡本 | 野村 | 作成日/Date 2023/02/02 | 5 / 5 |