

構成内容 / Components				
No.	名称 / Part name	数量 / Pcs	材質 / Material	色・表面処理 / Color・Finish
1	パネル / Panel	2	アルミ板 / Aluminium A1100 t=1.5	表面 メタリックシルバー塗装, 裏面 導通処理 / Silver, Painted (outside) • Unfinished (inside)
2	上カバー / Top cover	1	アルミ押出材 / Extruded aluminium A6063S-T5	シルバー, 表面塗装-内面無処理 / Silver, Painted (outside) • Unfinished (inside)
3	下カバー / Bottom cover	1	アルミ押出材 / Extruded aluminium A6063S-T5	シルバー, 表面塗装-内面無処理 / Silver, Painted (outside) • Unfinished (inside)
4	フレーム / Flanged frame	2	PC+ABS樹脂 / Polycarbonate-ABS UL94V-0	塗装無 : ブラック, グレー / Black, Gray • Unpainted 塗装付 : ネイビー / Navy • Painted
5	シールドガスケット / Fabric-over-foam gasket	2	導電性繊維, TPE / Conductive fabric : TPE	メタリックグレー / Metallic gray
6	取付ビス(M5×12 六角穴付) / Screw	8	ステンレス / Stainless steel	無処理 / Unfinished

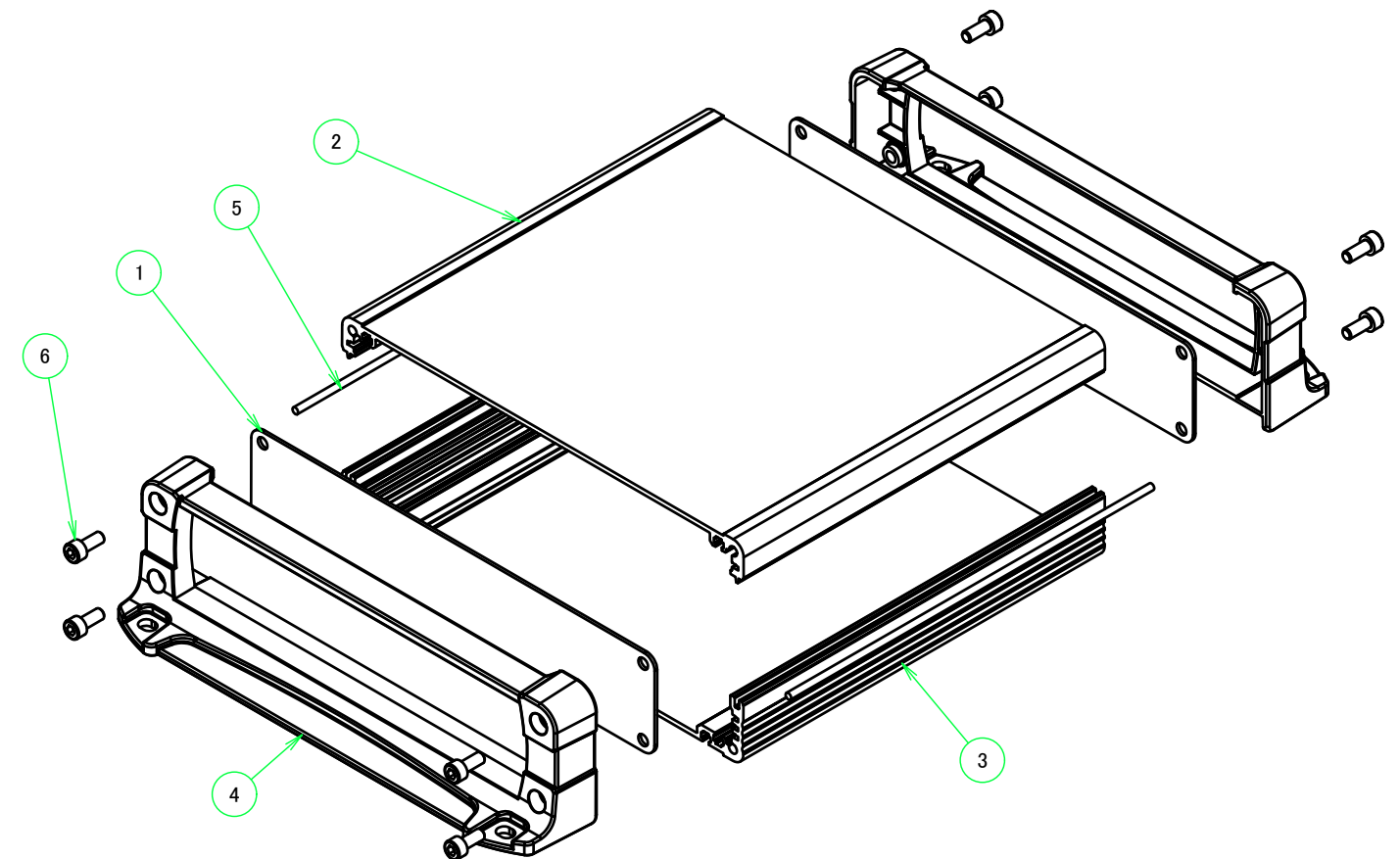
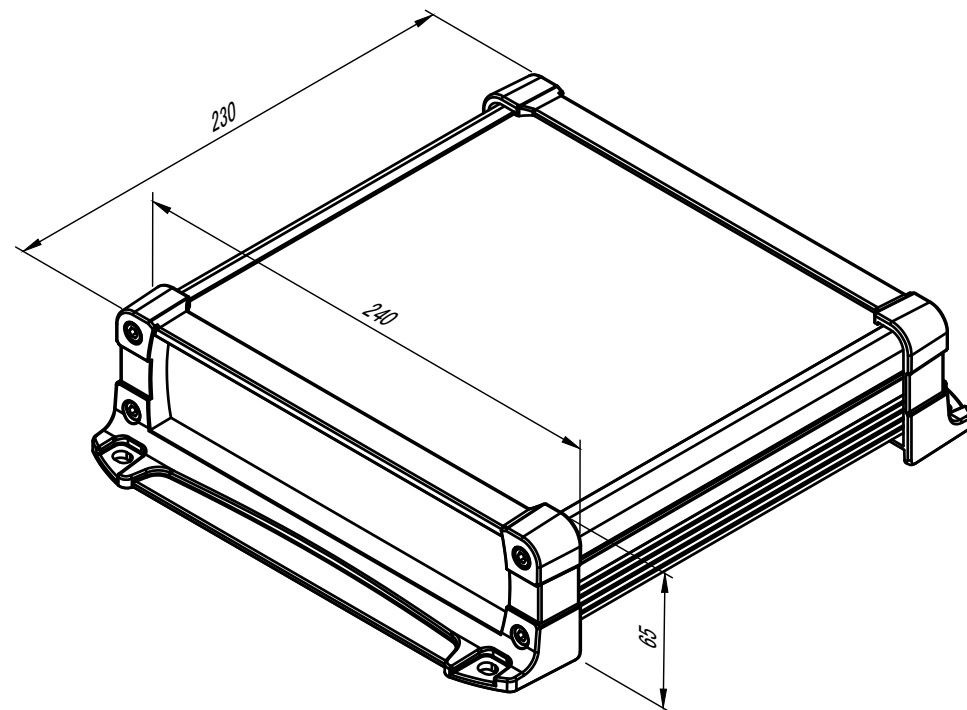

色仕様(型番末尾□□) / Color type		
記号 / Code	上下カバー / Cover	フレーム / Flanged frame
SB	シルバー / Silver	ブラック / Black
SG	シルバー / Silver	グレー / Gray
SN	シルバー / Silver	ネイビー / Navy

株式会社タカチ電機工業 <small>TAKACHI ELECTRONICS ENCLOSURE CO., LTD.</small>		品名/Title フランジ足付アルミケース EMCシールドタイプ FLANGED ALUMINIUM EMC SHIELD CASE	尺度/Scale 1:3	
承認/Approved	検図/Checked	製図/Created		型番/Product number EXEF24-7-23□□
	岡本	大江	作成日/Date 2019/01/25	1 / 5

B-B (1:4)

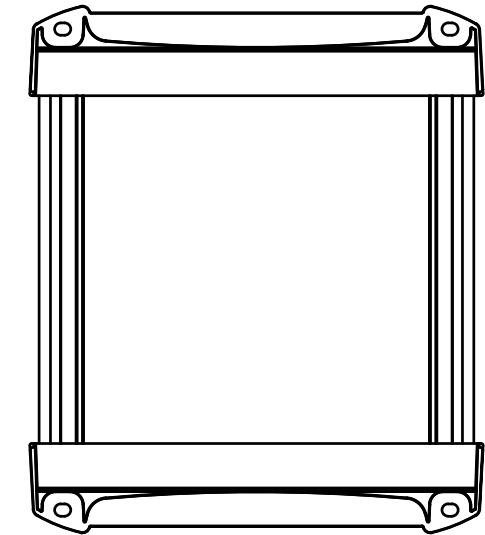
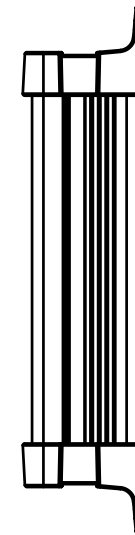
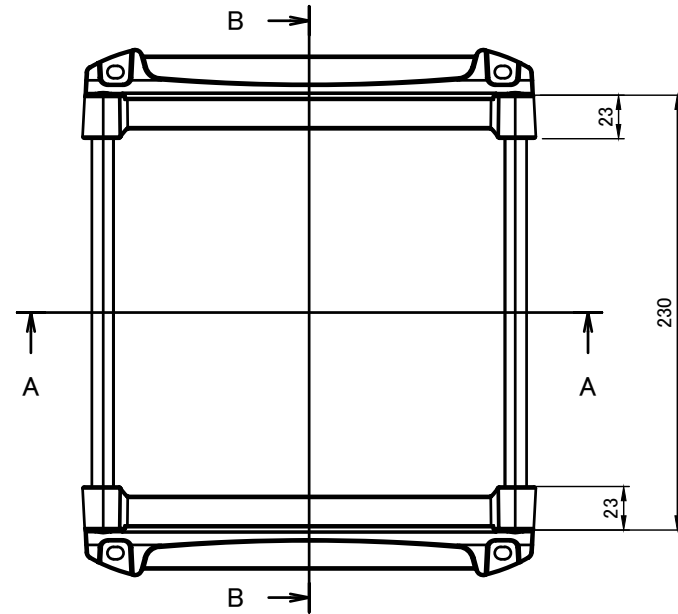
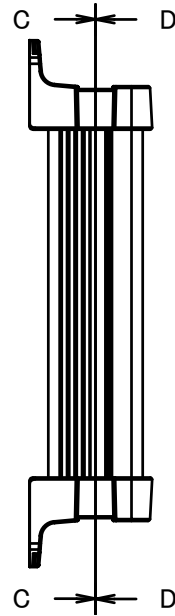
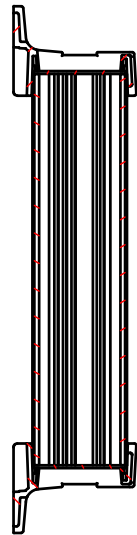

4-M5 六角穴付ボルト
4-M5 Countersunk hole

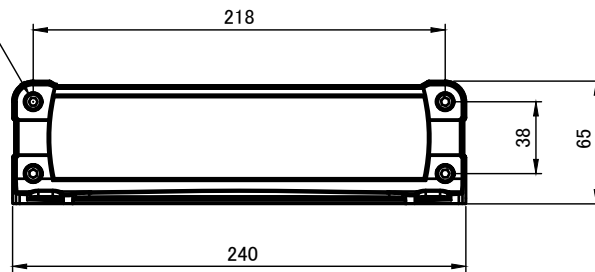

C-C (1:4)

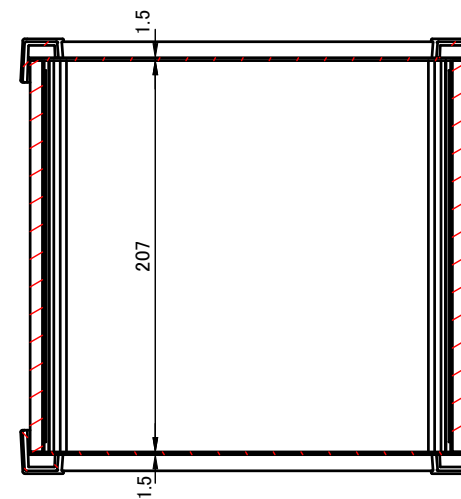

D-D (1:4)

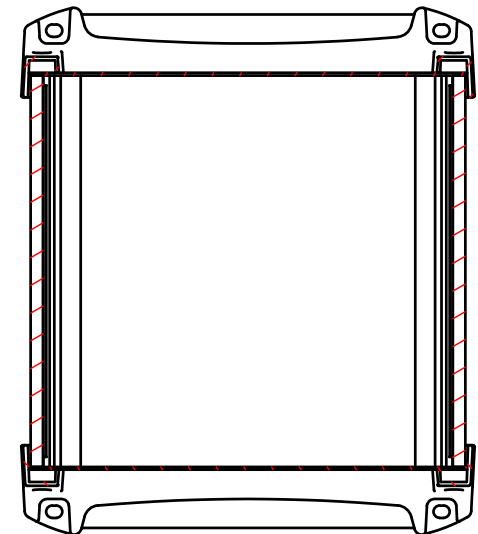

A-A (1:4)

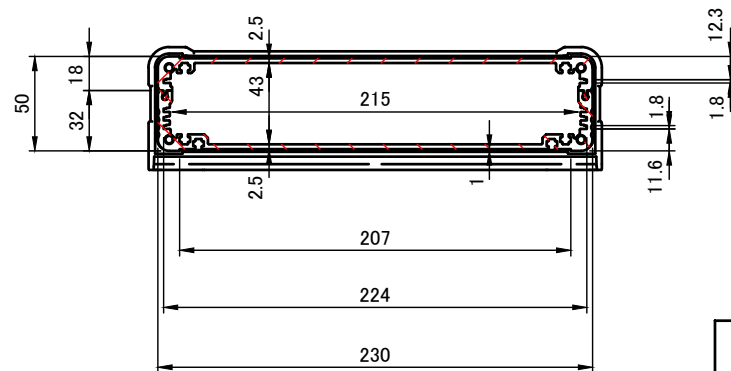

株式会社タカチ電機工業 TAKACHI ELECTRONICS ENCLOSURE CO., LTD.		品名/Title フランジ足付アルミケース EMCシールドタイプ FLANGED ALUMINIUM EMC SHIELD CASE	尺度/Scale 1:4
承認/Approved	検図/Checked	製図/Created	
	岡本	大江	作成日/Date 2019/02/20
			2 / 5

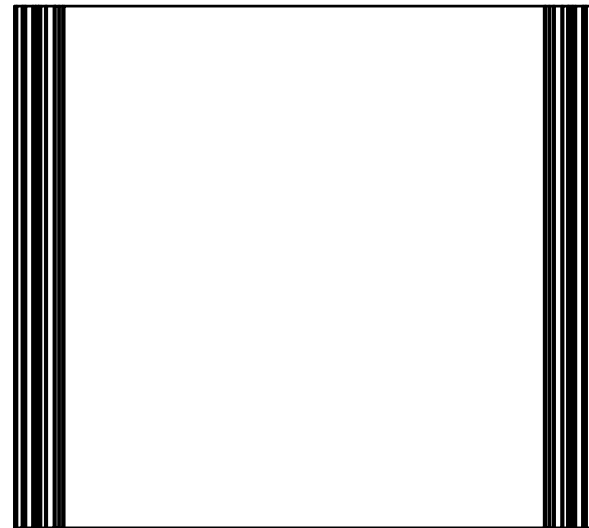
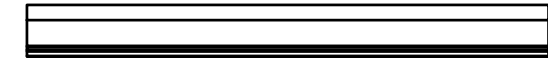
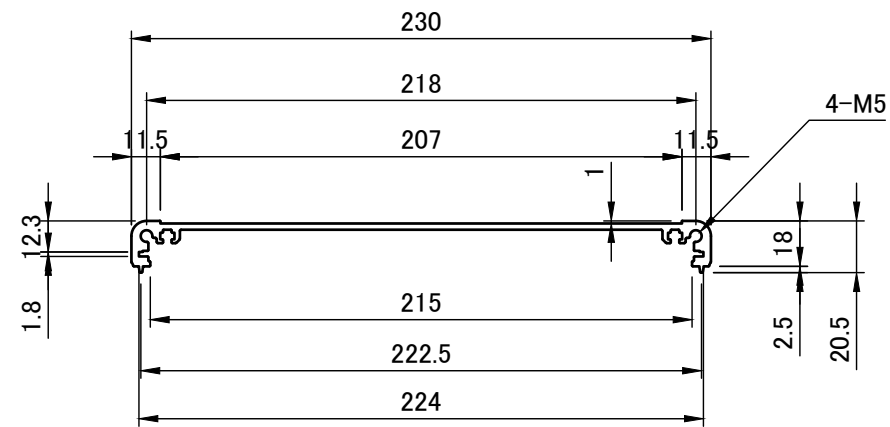
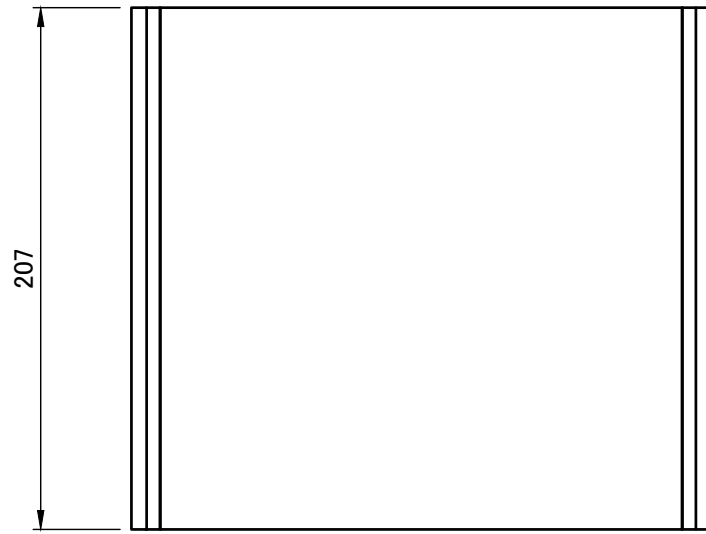
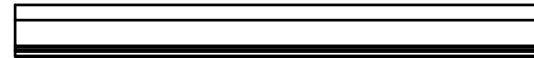

株式会社タカチ電機工業 TAKACHI ELECTRONICS ENCLOSURE CO., LTD.		品名/Title 上カバー TOP COVER	尺度/Scale 1:3
承認/Approved	検図/Checked	製図/Created	
	岡本	大江	作成日/Date 2019/01/15
			3 / 5

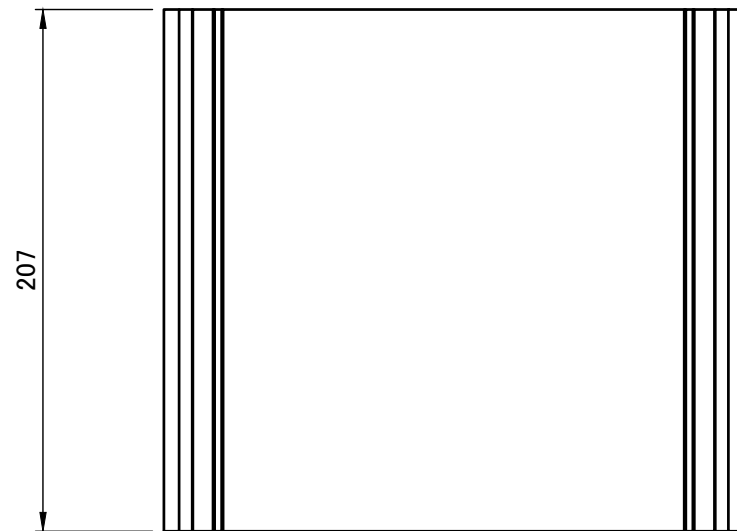
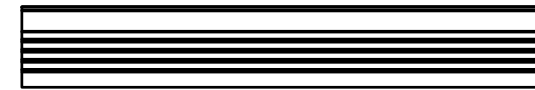
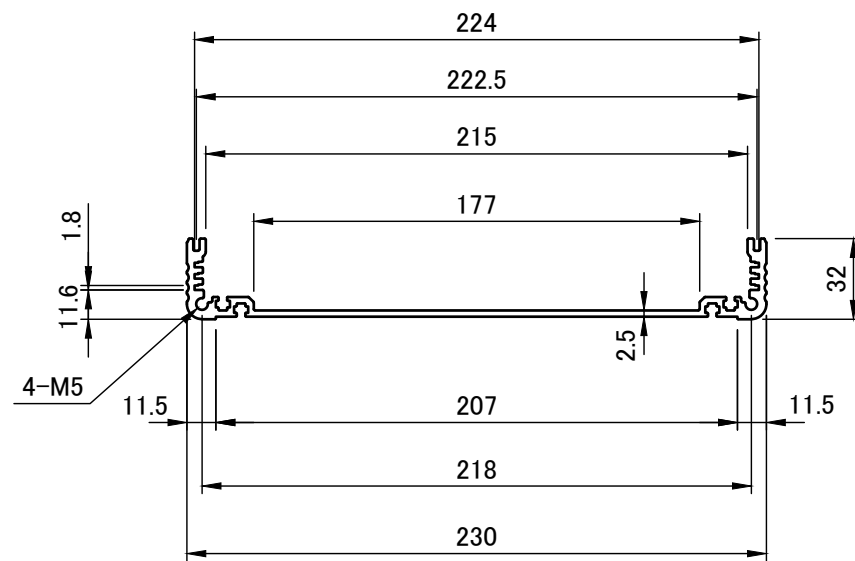
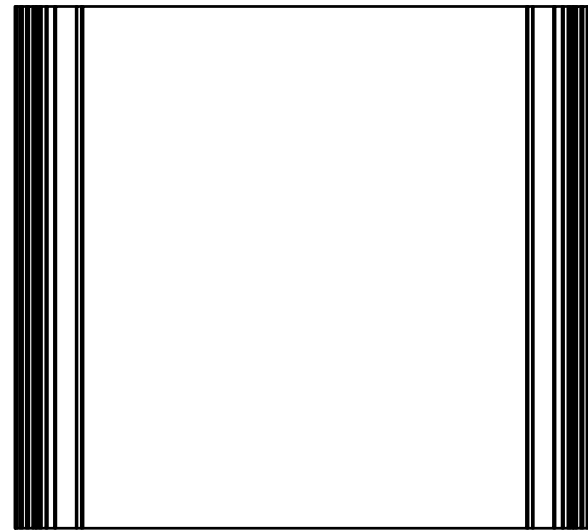
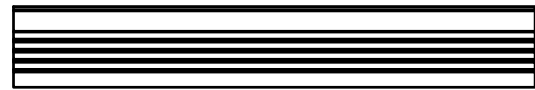

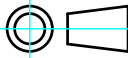

 株式会社タカチ電機工業 TAKACHI ELECTRONICS ENCLOSURE CO., LTD.		品名/Title 下カバー BOTTOM COVER	
承認/Approved	検図/Checked	製図/Created	
	岡本	大江	作成日/Date 2019/01/15
			尺度/Scale 1:3
			4 / 5

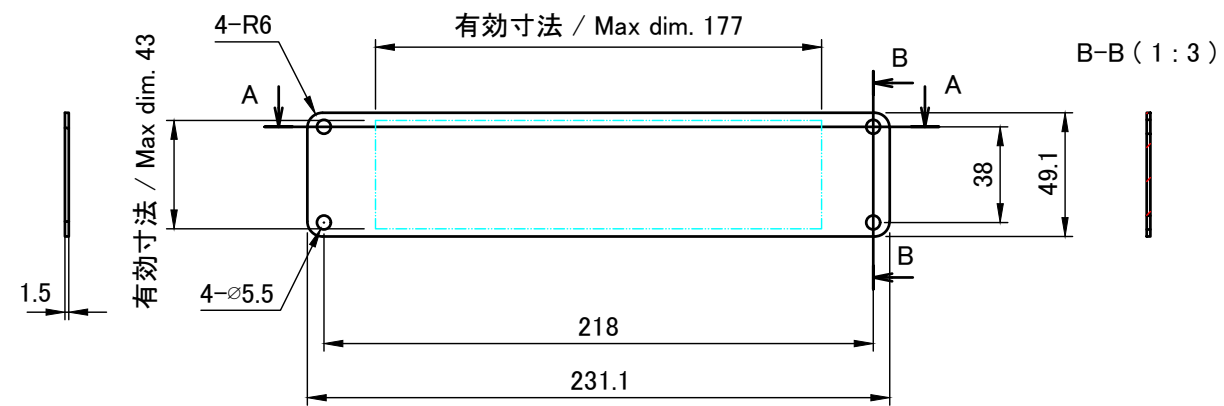
A-A (1:3)

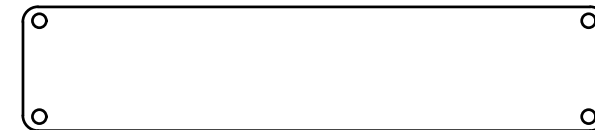
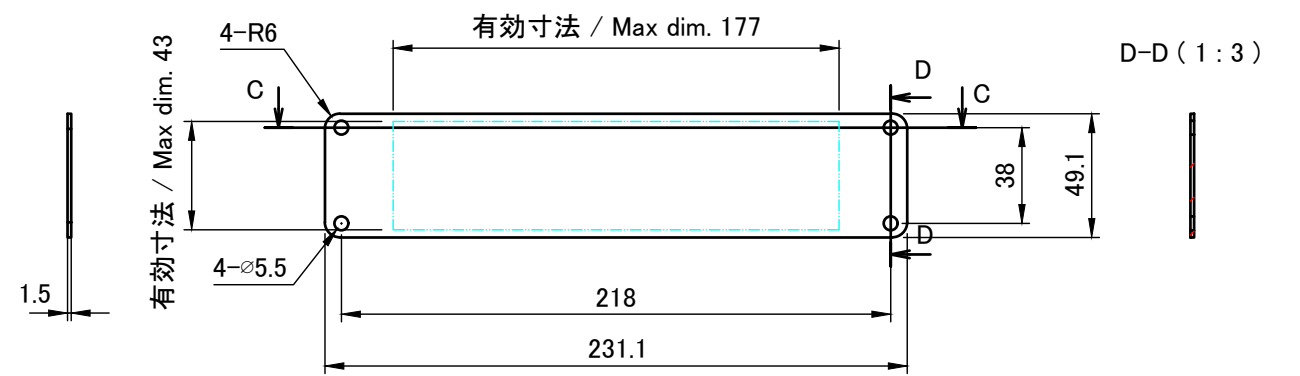

C-C (1:3)

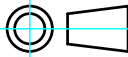

 株式会社タカチ電機工業 TAKACHI ELECTRONICS ENCLOSURE CO., LTD.		品名/Title パネル PANEL	
承認/Approved	検図/Checked	製図/Created	
	岡本	大江	作成日/Date 2019/01/16
			尺度/Scale 1:3
			5 / 5