

構成内容 / Components				
No.	名称 / Part name	数量 / Pcs	材質 / Material	色・表面処理 / Color・Finish
1	パネル / End panel	2	アルミ板 / Aluminium A1050P	シルバーアルマイト,ブラックアルマイト / Silver,Black・Anodized
2	上カバー / Top cover	1	アルミ押出材 / Extruded aluminium A6063S-T5	シルバーアルマイト,ブラックアルマイト / Silver,Black・Anodized
3	下カバー / Bottom cover	1	アルミ押出材 / Extruded aluminium A6063S-T5	シルバーアルマイト,ブラックアルマイト / Silver,Black・Anodized
4	取付ビス(M5×10 皿六角穴付) / Screw	8	ステンレス / Stainless steel	無処理 / Unfinished
5	ゴム足 / Rubber feet	4	ポリウレタン / Polyurethane	ブラック / Black

※ゴム足は任意の場所に貼り付けできます。
 ※Adhesive rubber feet included.

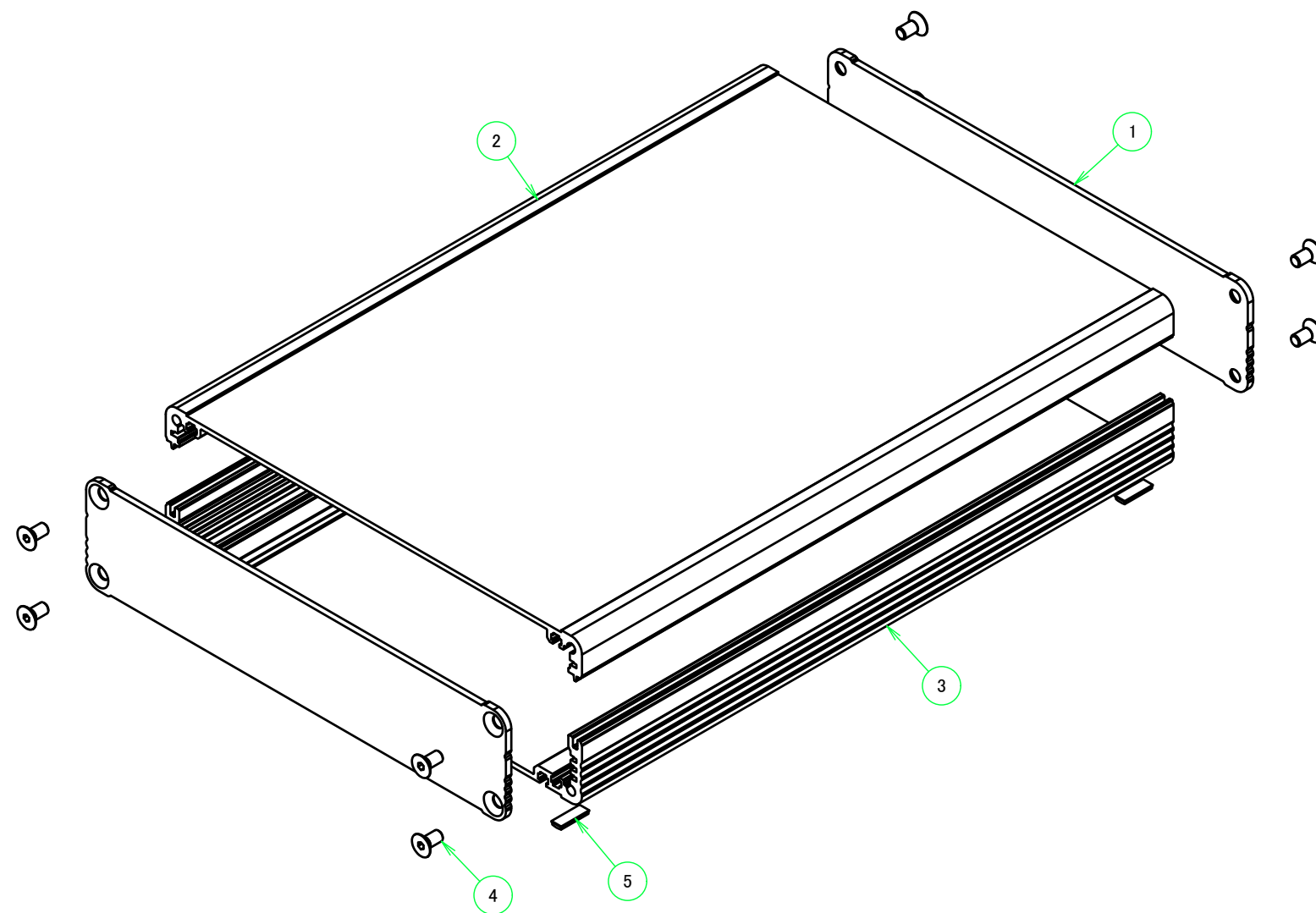
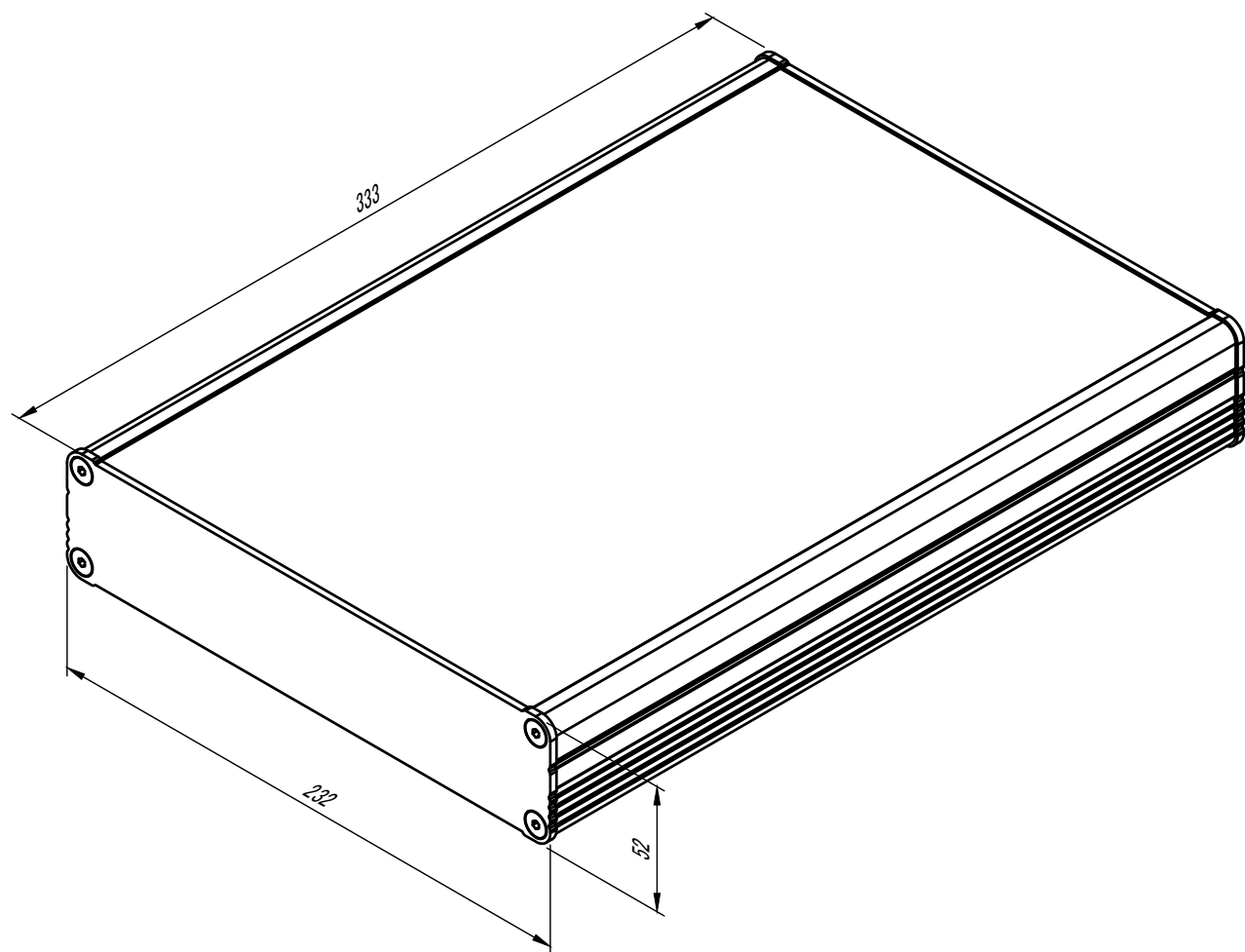

色仕様(型番末尾口)/Color type		
記号/Code	上下カバー/Cover	パネル/Panel
SS	シルバー/Silver	シルバー/Silver
SB	シルバー/Silver	ブラック/Black
BS	ブラック/Black	シルバー/Silver
BB	ブラック/Black	ブラック/Black

株式会社タカチ電機工業 <small>TAKACHI ELECTRONICS ENCLOSURE CO., LTD.</small>			品名/Title アルミ押出材ケース EXTRUDED ALUMINIUM CASE	
承認/Approved	検図/Checked 大江	製図/Created 岡本	型番/Product number EX23-5-33□□	尺度/Scale 1 : 2.5
			作成日/Date 2019/01/24	1 / 5

ゴム足
Rubber feet

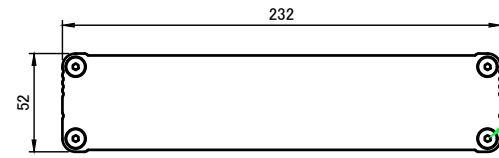
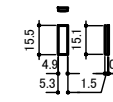

4-M5皿ビス
4-M5 Countersunk

B-B (1:4)

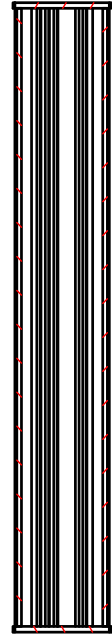

C → D

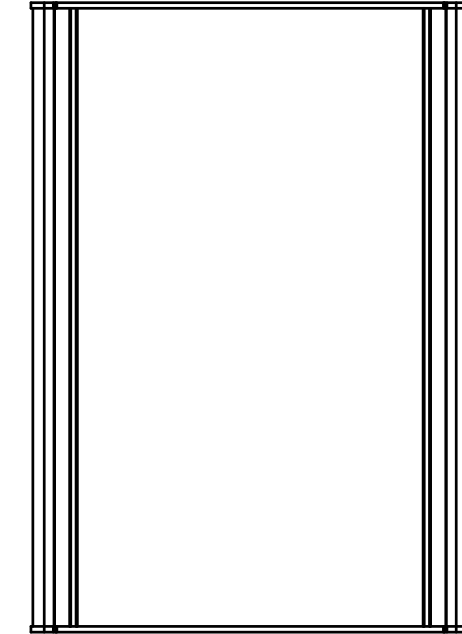
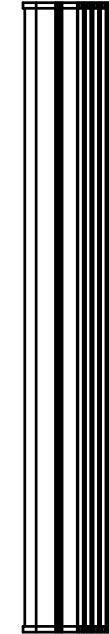
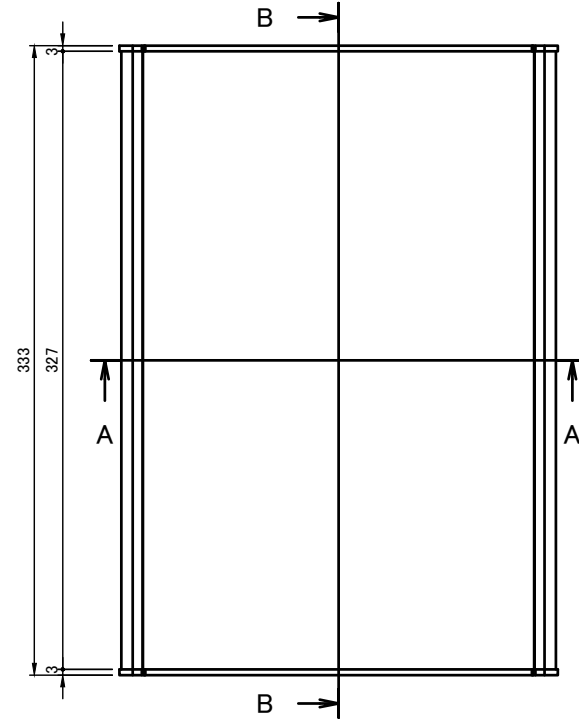
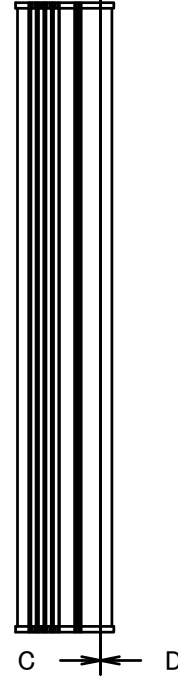

C-C (1:4)

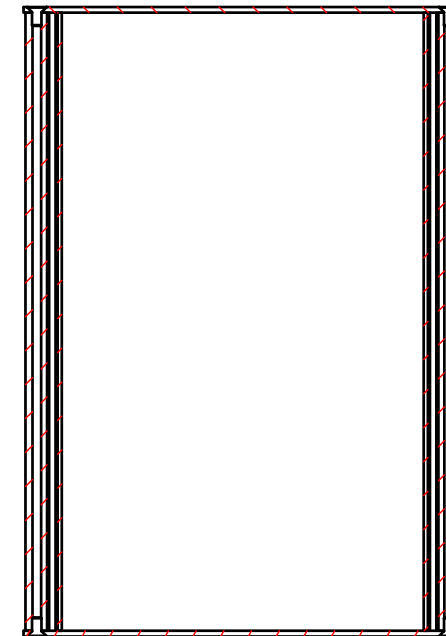

D-D (1:4)

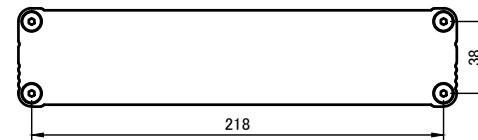
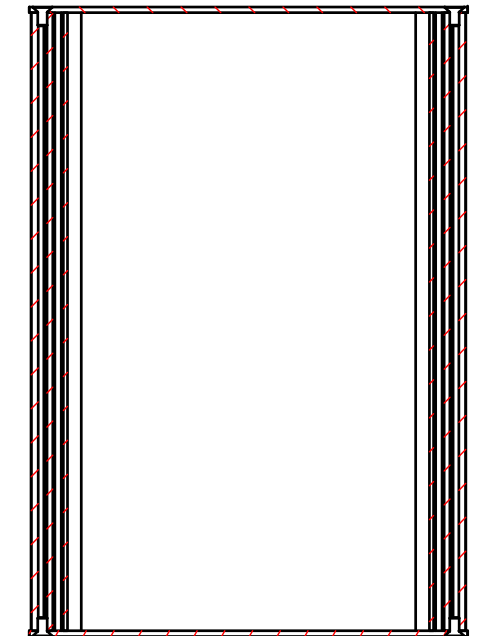

A-A (1:4)

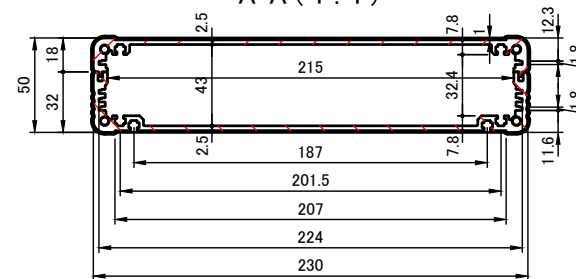

株式会社タカチ電機工業 TAKACHI ELECTRONICS ENCLOSURE CO., LTD.		品名/Title アルミ押出材ケース EXTRUDED ALUMINIUM CASE	尺度/Scale 1 : 4
承認/Approved	検図/Checked	製図/Created	
	大江	岡本	作成日/Date 2019/01/24
			2 / 5

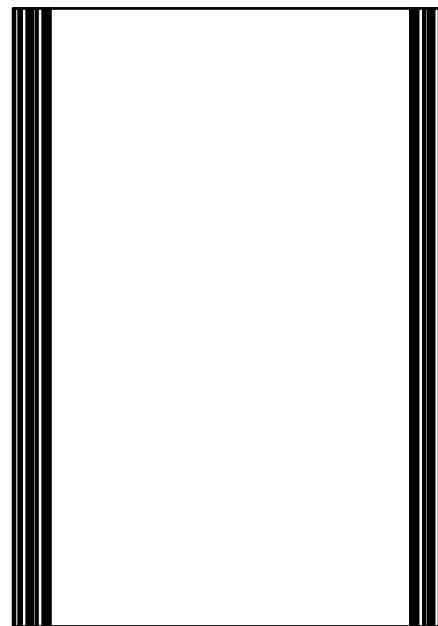
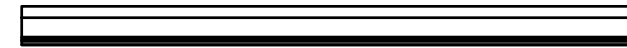
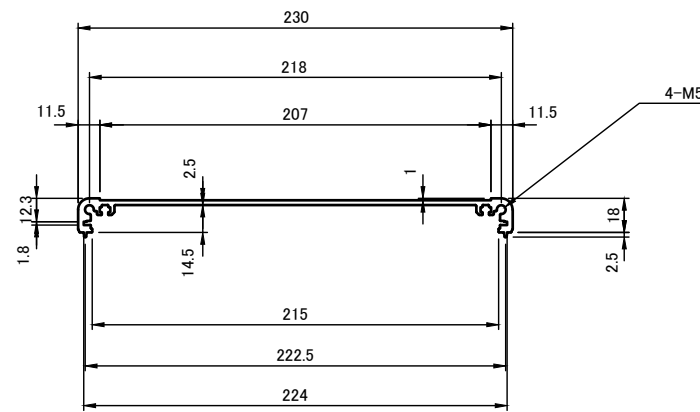
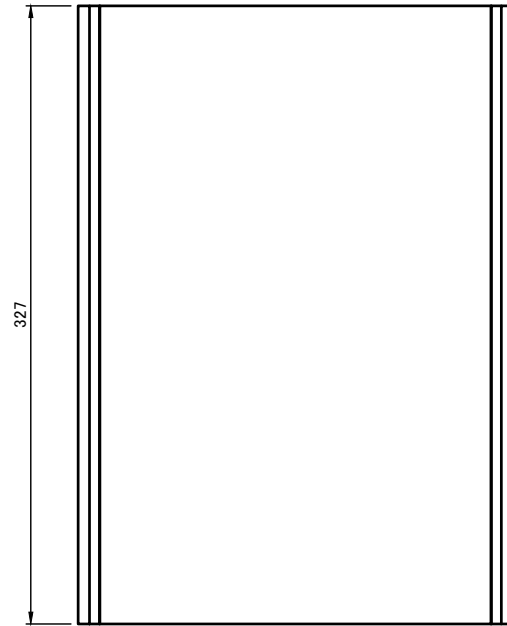
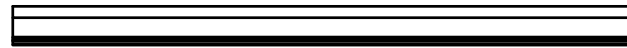

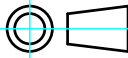
 株式会社タカチ電機工業 TAKACHI ELECTRONICS ENCLOSURE CO., LTD.		品名/Title 上カバー TOP COVER	
承認/Approved	検図/Checked	製図/Created	
	岡本	大江	作成日/Date 2019/01/15
			尺度/Scale 1:4
			3 / 5

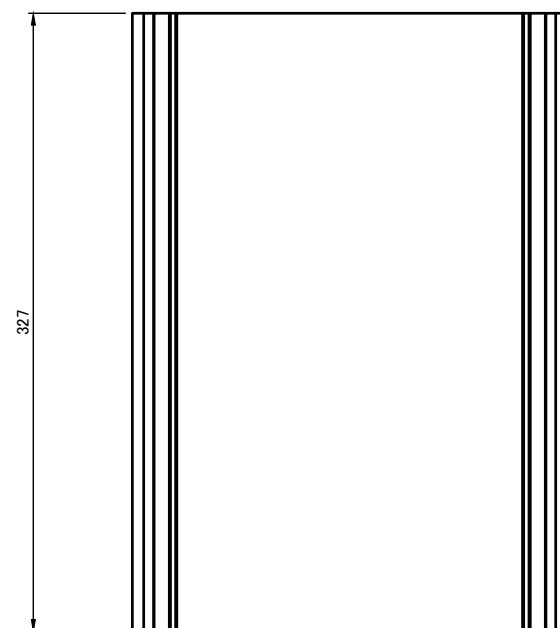
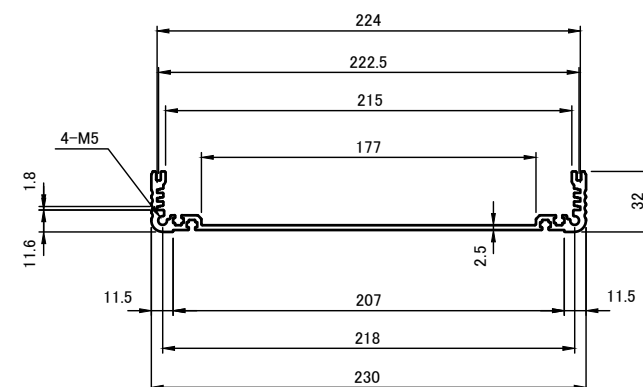
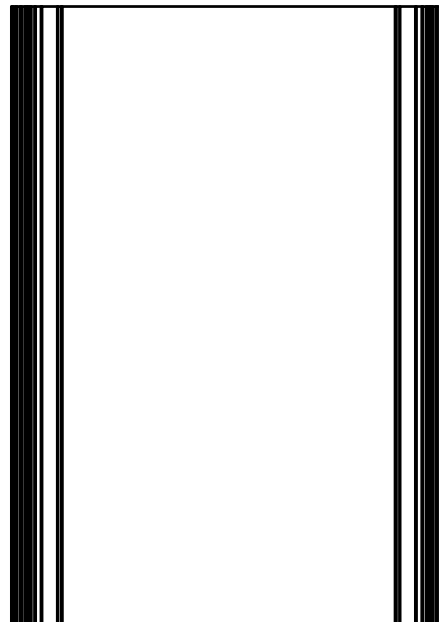

 株式会社タカチ電機工業 TAKACHI ELECTRONICS ENCLOSURE CO., LTD.		品名/Title 下カバー BOTTOM COVER	 尺度/Scale 1:4
承認/Approved	検図/Checked	製図/Created	
	岡本	大江	作成日/Date 2019/01/15
			4 / 5

パネル / End panel

B-B (1:2.5)

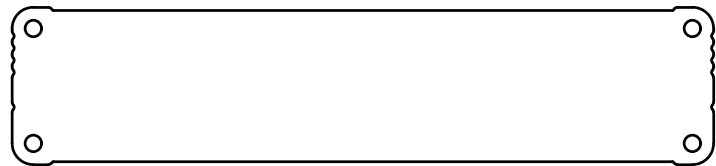
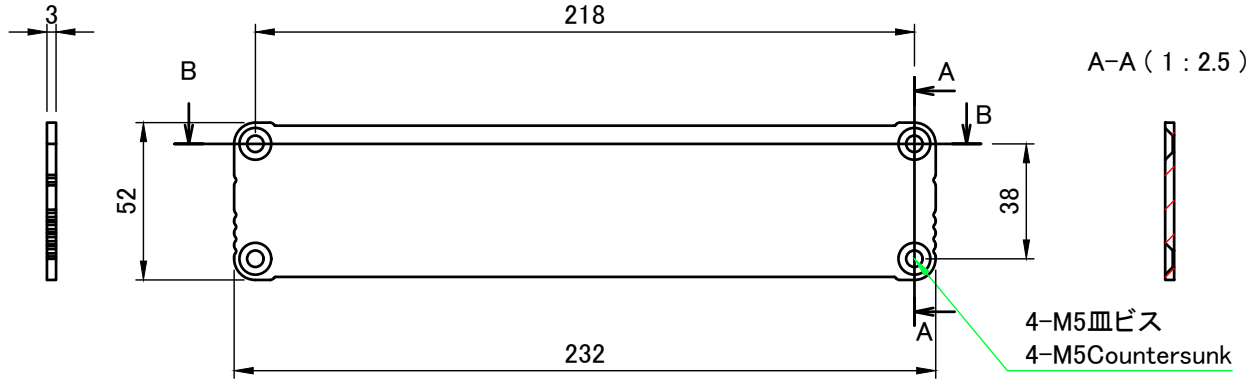

D-D (1:2.5)

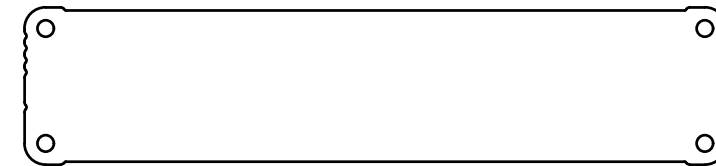
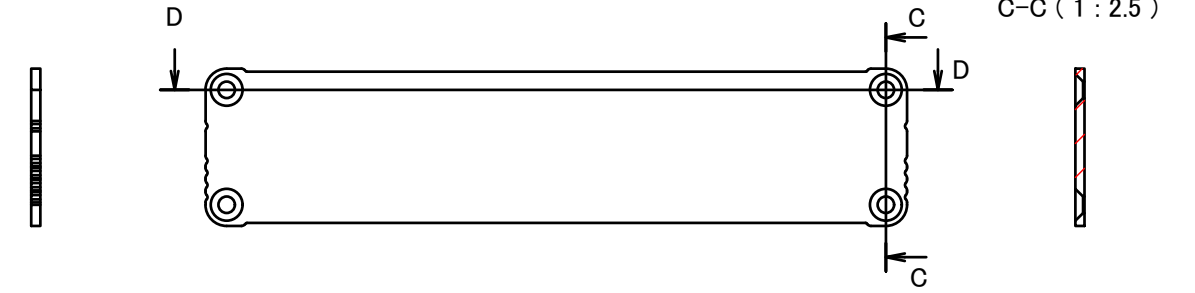

株式会社タカチ電機工業 <small>TAKACHI ELECTRONICS ENCLOSURE CO., LTD.</small>		品名/Title アルミ押出材ケース EXTRUDED ALUMINIUM CASE	尺度/Scale 1:2.5
承認/Approved	検図/Checked	製図/Created	
	大江	岡本	作成日/Date 2019/01/25
			5 / 5