

■テクニカルデータ/Technical Data■

使用温度範囲 / Operating temperature	-40°C~+105°C
※熱抵抗値 / Thermal resistant rate	3.76°C/W

※熱抵抗値算出の条件 / Thermal resistance test condition

- ・自然空冷 / Ambient air cooling
- ・フィンが地面に垂直で温度上昇60°Cの時 / Heat-sink fins are set perpendicular to the ground with temperature at 60°C
- ・押出しがアルマイト品 / Anodized extruded aluminium
- ・全面素子 / Heat source is applied on the opposite side (inner side) of the fins

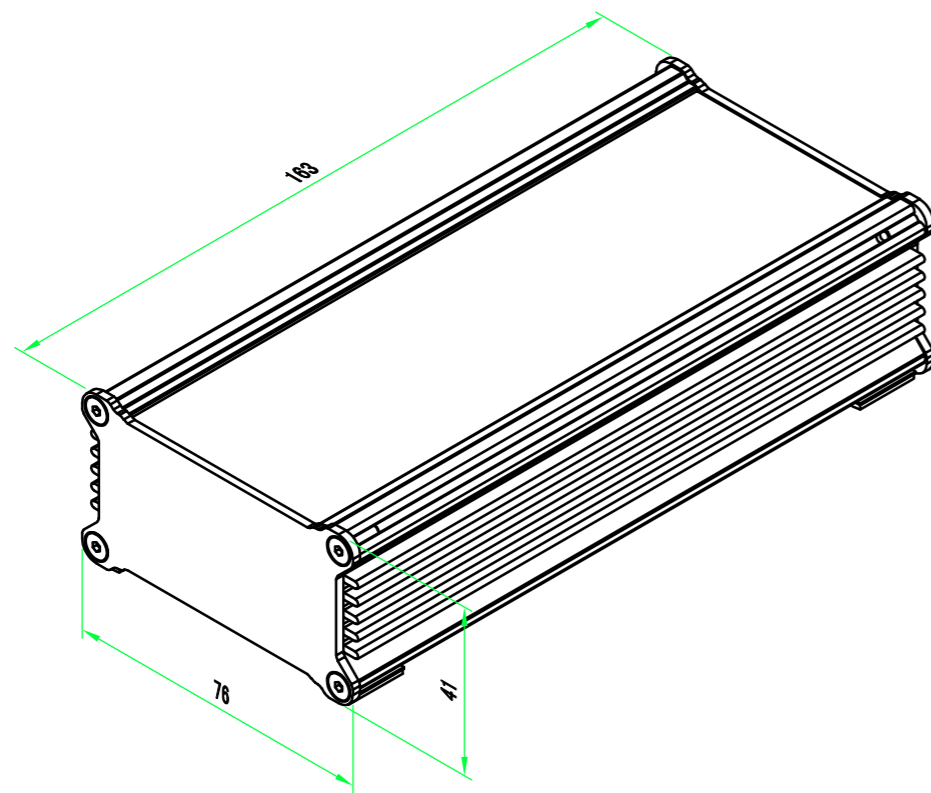

構成内容 / Components

No.	名称 / Part name	数量 / Pcs	材質 / Material	色・表面処理 / Color・Finish
1	ボディフレーム / Body frame	1	アルミ押出材 / Extruded aluminium A6063S-T5	シルバーアルマイト & クリア塗装 / Silver anodized & clear coated
2	パネル / End panel	2	アルミ板 / Aluminium A1050P	表面シルバーアルマイト・裏面未処理 / Silver anodized(outside);Unfinished(inside)
3	取付ビス(六角穴付皿M3×8) / Hex socket screw	8	ステンレス / Stainless steel	無処理 / Unfinished
4	ゴム足 / Rubber feet	4	ポリウレタン / Polyurethane	ブラック / Black

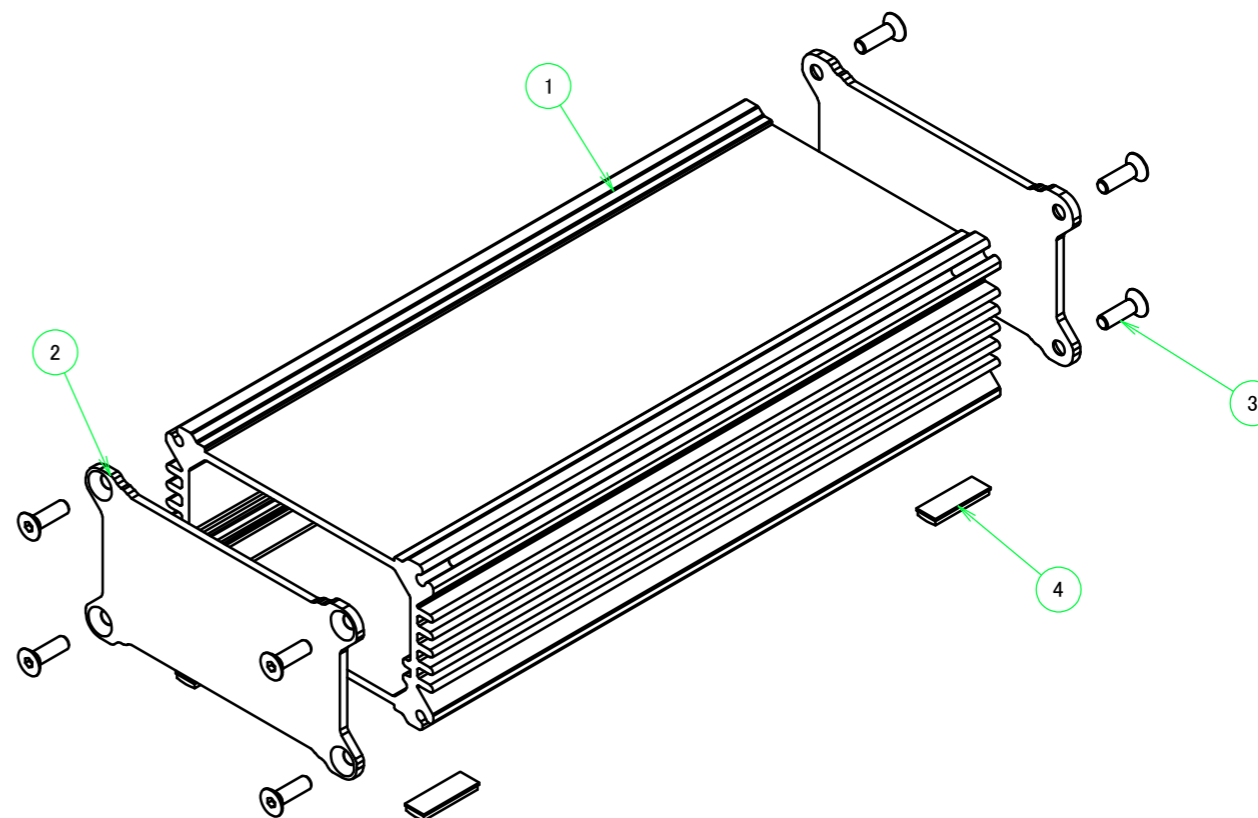

本図面および付帯する部品図の著作権は株式会社タカチ電機工業に帰属します。 / Copyright (C) TAKACHI ELECTRONICS ENCLOSURE CO., LTD. All Rights Reserved.

株式会社タカチ電機工業 TAKACHI ELECTRONICS ENCLOSURE CO., LTD.			品名/Title アルミ放熱ケース HEAT-SINK ALUMINIUM ENCLOSURE	尺度/Scale 1 / 1.5
承認/Approved	検図/Checked	製図/Created	型番/Product number AWA8-4-16SS	
中根	王	岡本	作成日/Date 2022/11/22	1 / 4

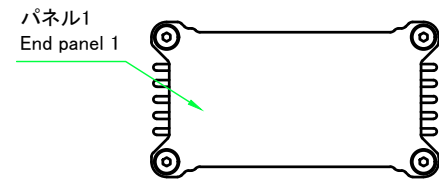

B-B (1:2)

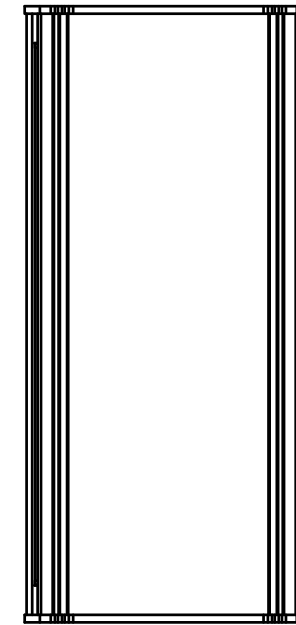
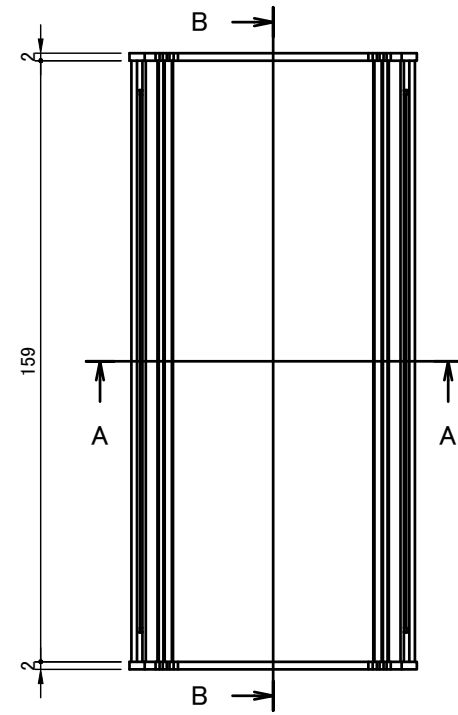
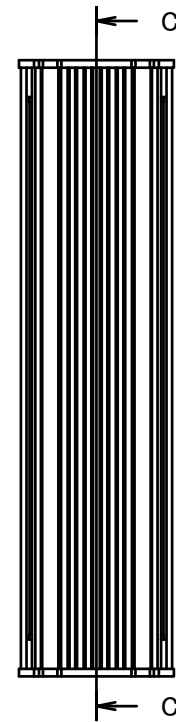
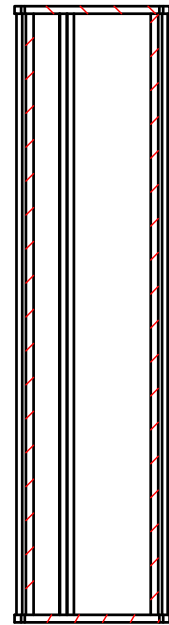

C-C (1:2)

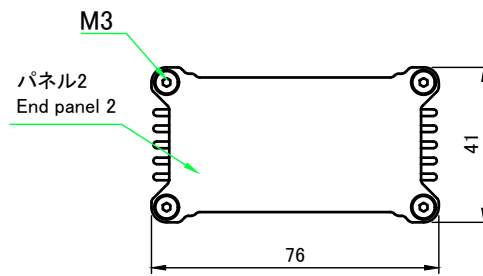
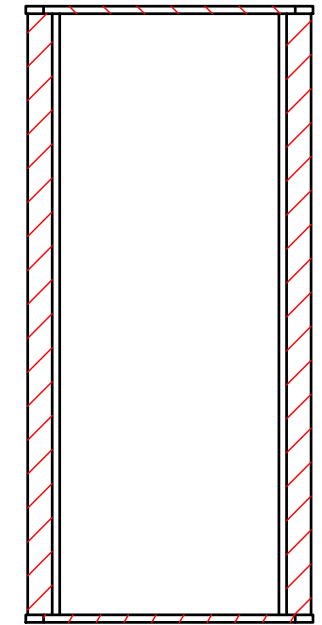

A-A (1:2)

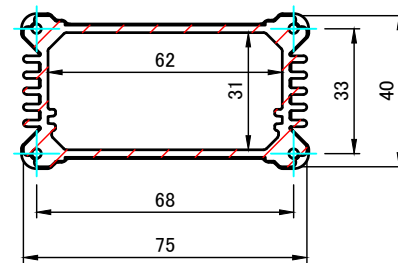

株式会社タカチ電機工業 TAKACHI ELECTRONICS ENCLOSURE CO., LTD.			品名/Title アルミ放熱ケース HEAT-SINK ALUMINIUM ENCLOSURE	尺度/Scale 1 / 2
承認/Approved	検図/Checked	製図/Created	型番/Product number AWA8-4-16SS	
中根	王	岡本	作成日/Date 2019/02/26	2 / 4

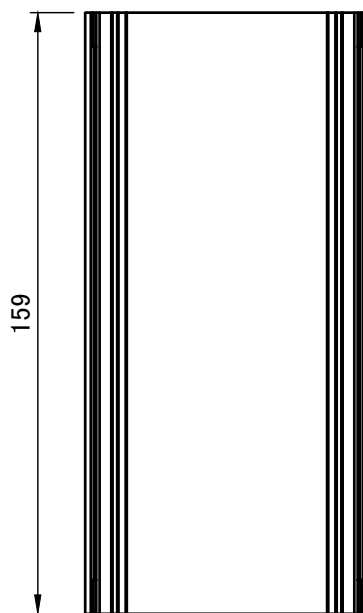
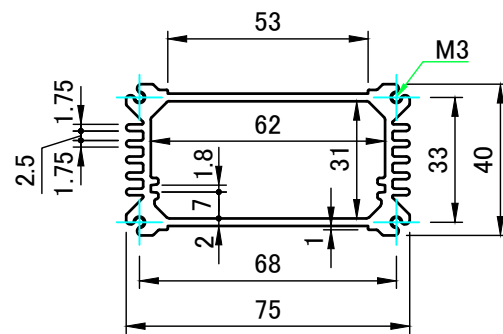

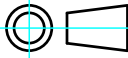
 株式会社タカチ電機工業 TAKACHI ELECTRONICS ENCLOSURE CO., LTD.			品名/Title ボディフレーム Body frame	
承認/Approved	検図/Checked	製図/Created	型番/Product number W75-H40-D159	
中根	王	岡本	作成日/Date 2019/02/26	3 / 4

パネル1
End panel 1

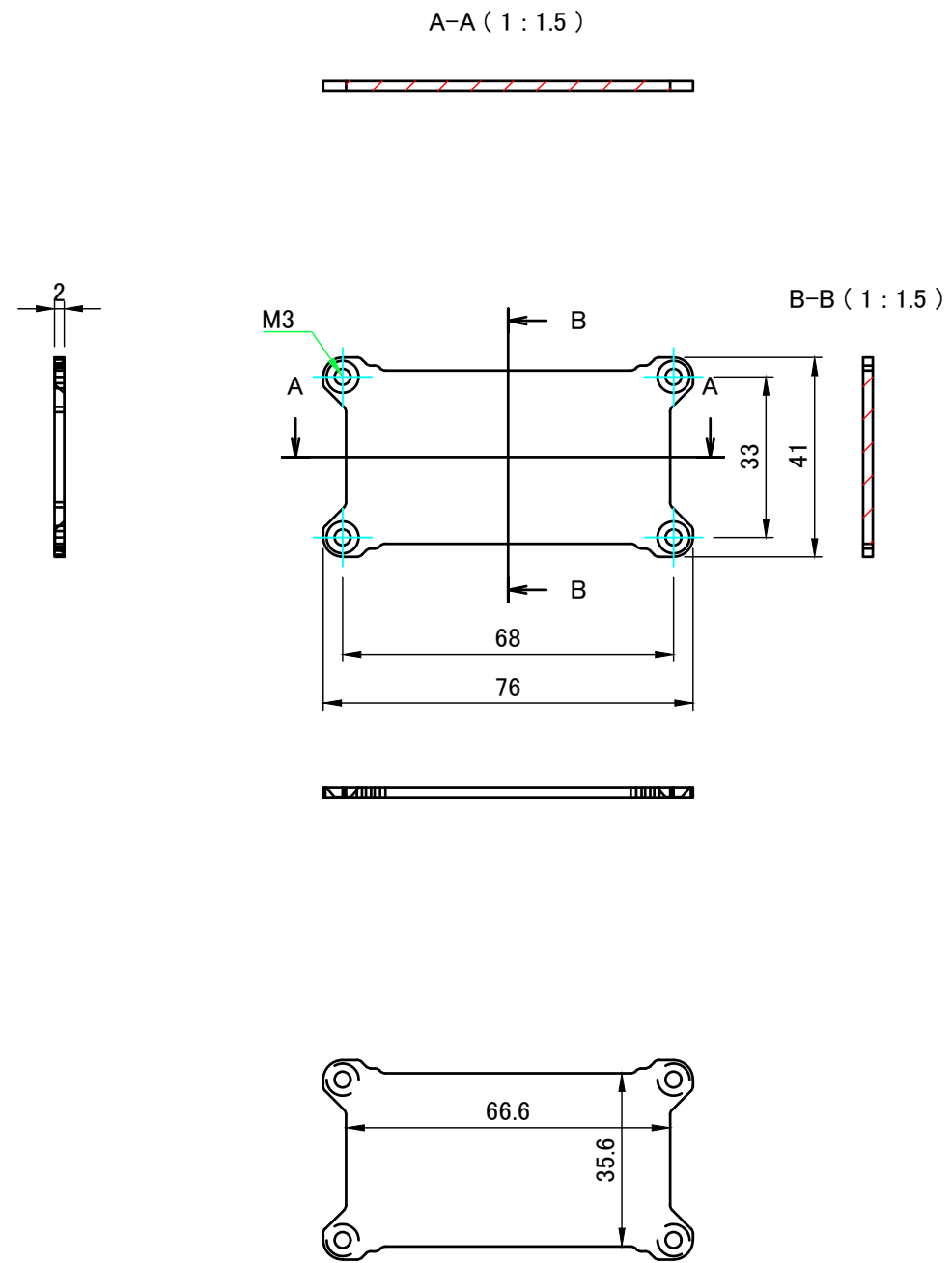

パネル2
End panel 2

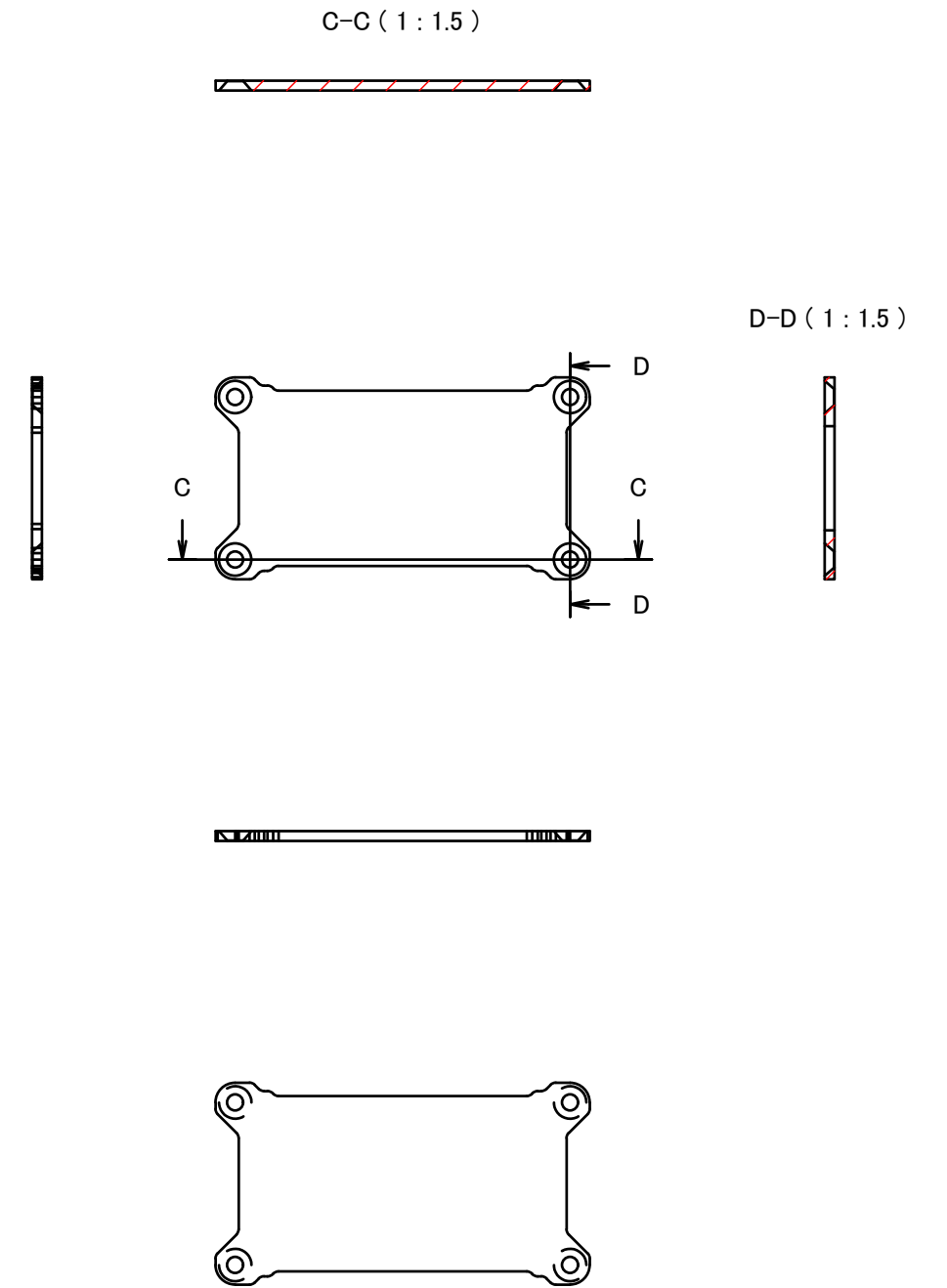

株式会社タカチ電機工業 TAKACHI ELECTRONICS ENCLOSURE CO., LTD.			品名/Title パネル End panel	尺度/Scale 1 / 1.5
承認/Approved	検図/Checked	製図/Created	型番/Product number W75-H40	
中根	王	岡本	作成日/Date 2019/02/26	4 / 4