

■テクニカルデータ/Technical Data■	
保護等級/Protection class	IP67
温度範囲/Operating temperature	-40°C~+105°C
締め付けトルク/Recommended torque	1.0N・m(10kgf・cm)
※熱抵抗値/Thermal resistant rate	1.54°C/W

※熱抵抗値算出の条件/Thermal resistance test condition

- ・自然空冷/Ambient air cooling
- ・フィンが地面に垂直で温度上昇60°Cの時/Heat-sink fins are set perpendicular to the ground with temperature at 60°C
- ・押し出しがアルマイト品/Anodized extruded aluminium
- ・全面素子/Heat source is applied on the opposite side (inner side) of the fins

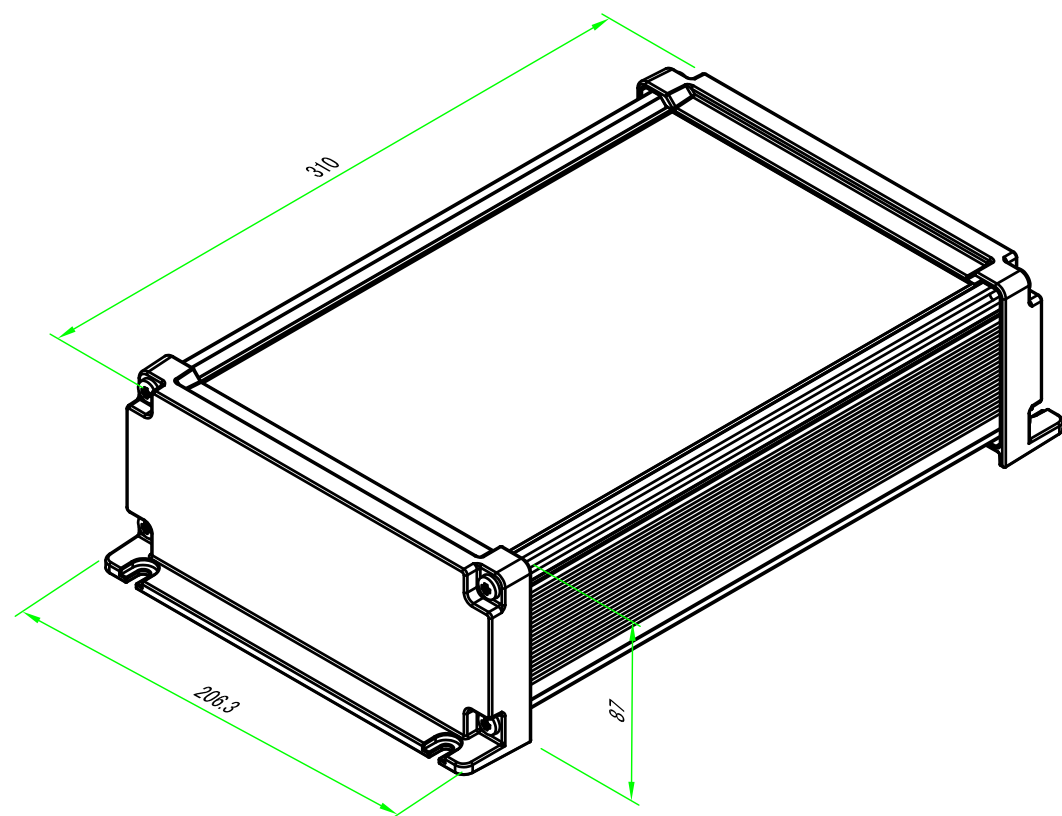

構成内容 / Components				
No.	名称 / Part name	数量 / Pcs	材質 / Material	色・表面処理 / Color・Finish
1	フランジ付側板/Flanged end panel	2	ADC12/Diecast aluminiumADC12	メタリックグレー・ブラック・粉体塗装/Metallic gray,black・Powder coated
2	ボディフレーム/Body frame	1	アルミ押出材/Extruded aluminium A6063S-T5	シルバー・ブラック・アルマイト&クリア塗装/Silver,black・Anodized & clear coated
3	ガスケット/Gasket	2	シリコン/Silicone	ブラック/Black
4	取付ビス/Screw	8	ステンレス(ハイト)M5×12/Stainless steel	無処理/Unfinished

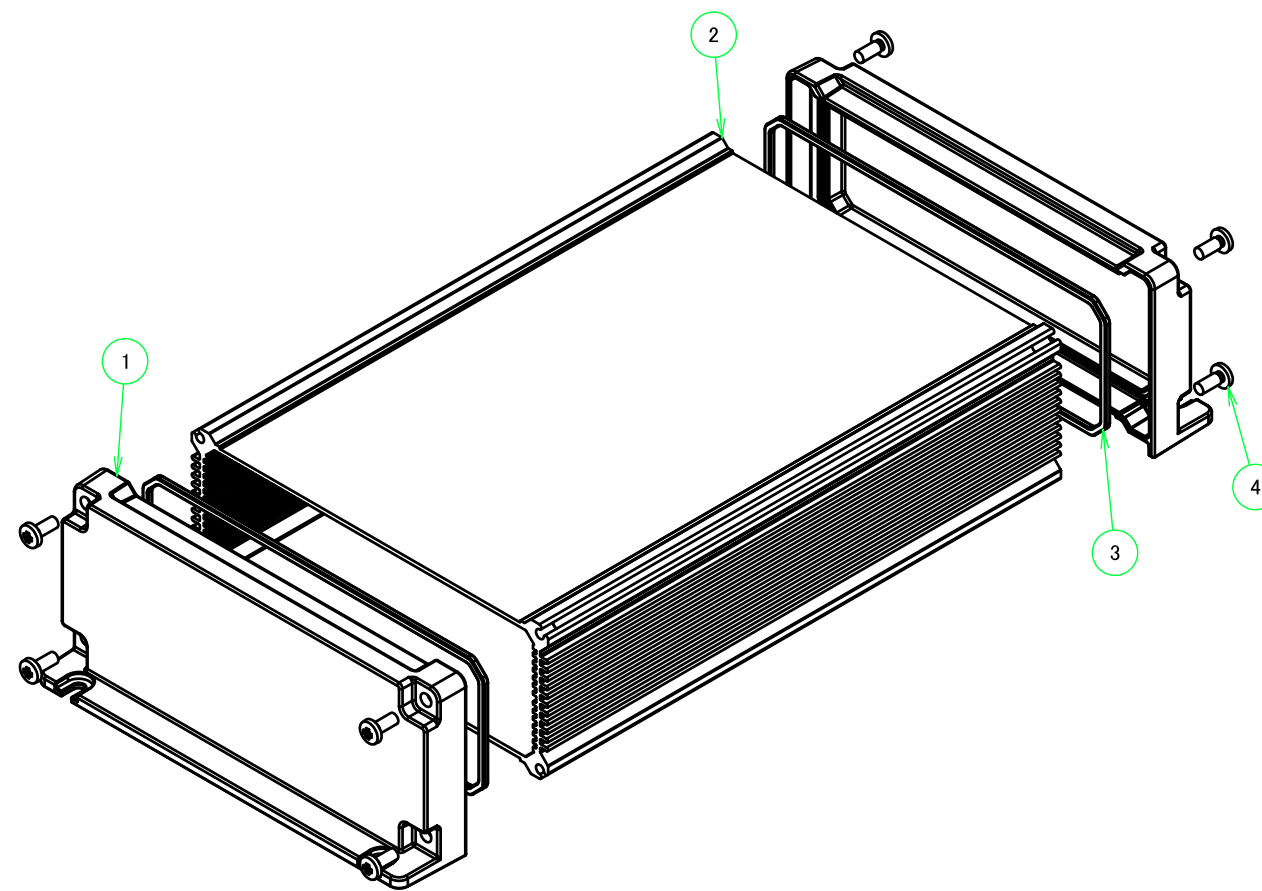

色仕様(型番末尾□□)/Color type		
記号/Code	パネル/Panel	ボディフレーム/Body frame
GS	メタリックグレー/Metallic gray	シルバー/Silver
BS	ブラック/Black	シルバー/Silver
BB	ブラック/Black	ブラック/Black

株式会社タカチ電機工業 <small>TAKACHI ELECTRONICS ENCLOSURE CO., LTD.</small>			品名/Title フランジ足付防水・防塵アルミケース IP67 FLANGED ALUMINIUM ENCLOSURE	尺度/Scale 1:3
承認/Approved 中根	検図/Checked 王	製図/Created 岡本	型番/Product number AW21-9-31N□□	
			作成日/Date 2020/10/26	1 / 4

フランジ付側板1
Flanged end panel 1

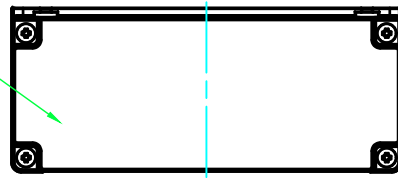

B-B (1:4)

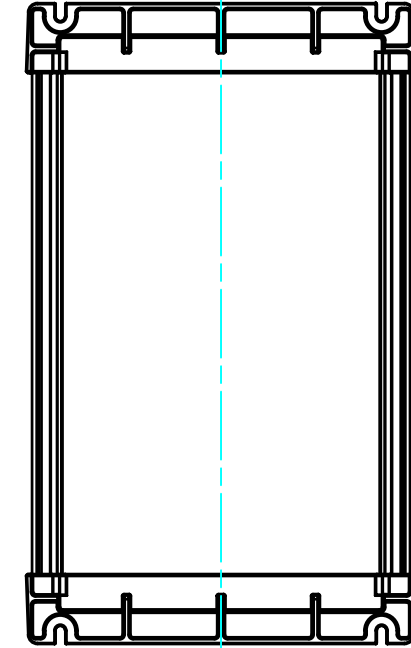
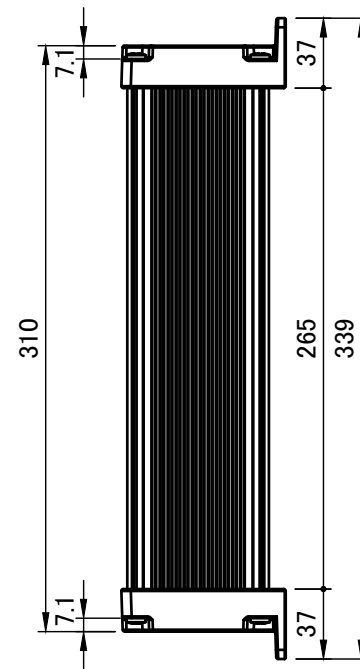
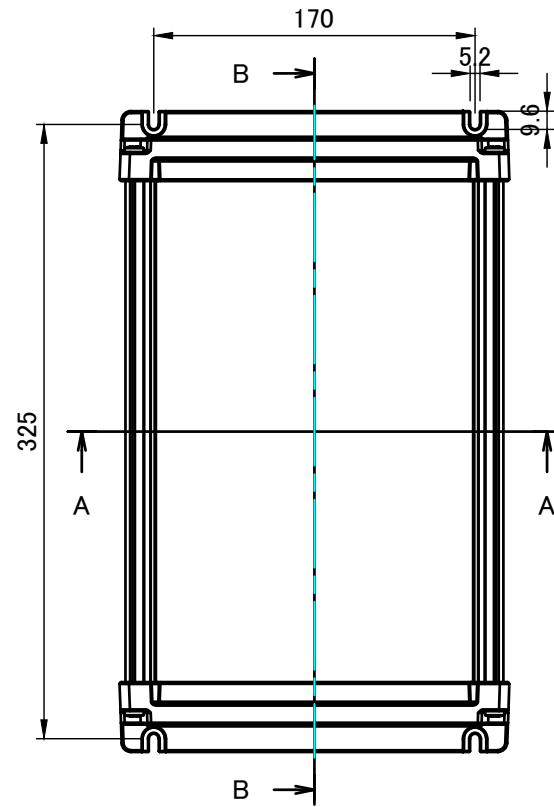
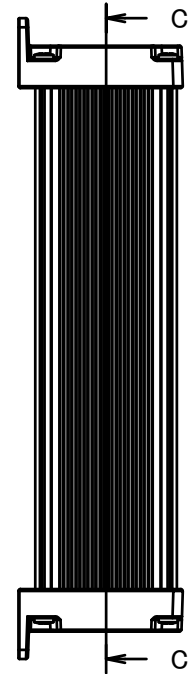
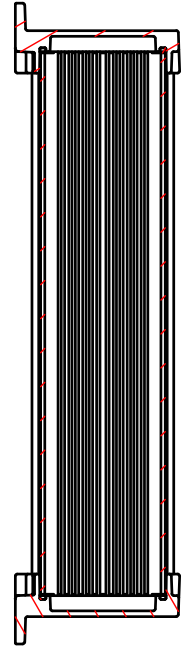

フランジ付側板2
Flanged end panel 2

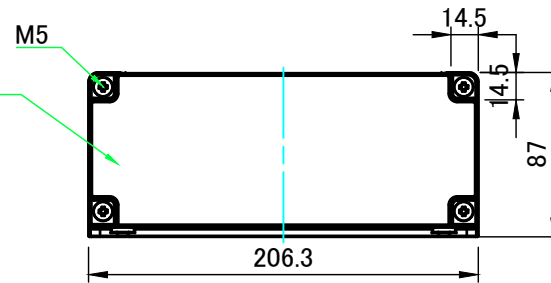

A-A (1:4)

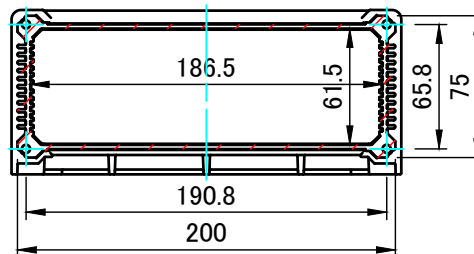

C-C (1:4)

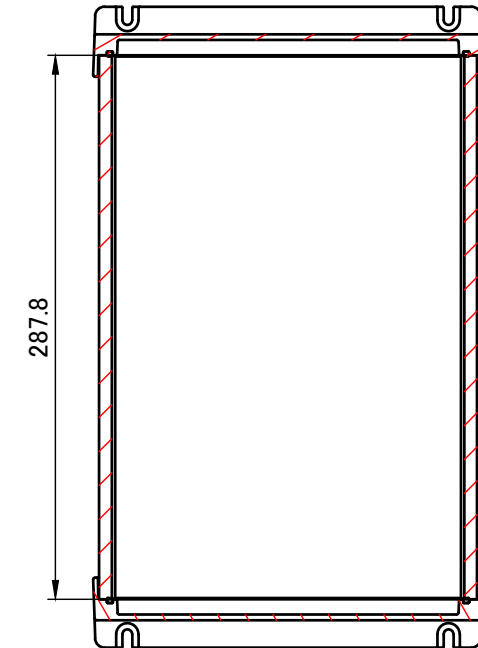

株式会社タカチ電機工業 TAKACHI ELECTRONICS ENCLOSURE CO., LTD.			品名/Title フランジ足付防水・防塵アルミケース IP67 FLANGED ALUMINIUM ENCLOSURE	尺度/Scale 1:4
承認/Approved 中根	検図/Checked 王	製図/Created 岡本	型番/Product number AW21-9-31N□□	
			作成日/Date 2017/07/14	2 / 4

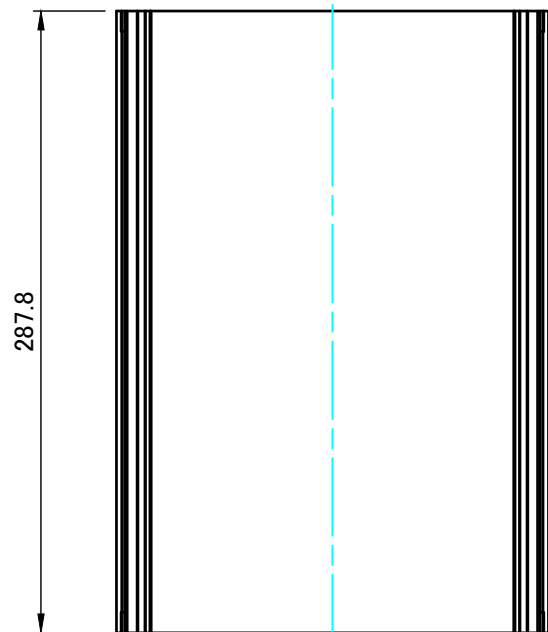
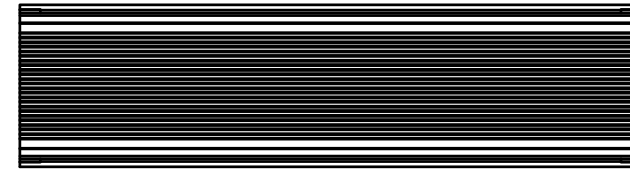
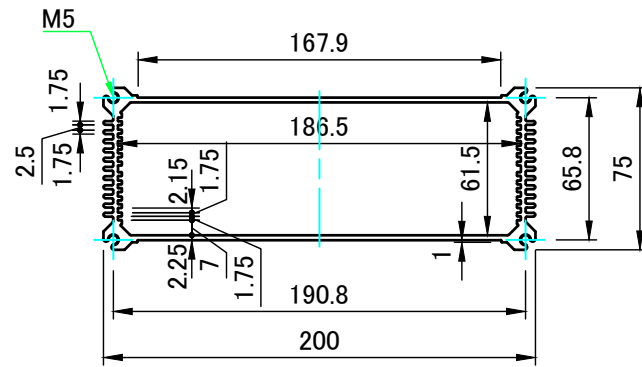
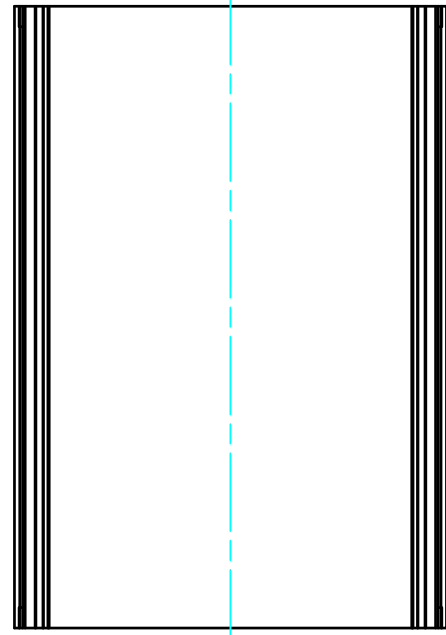
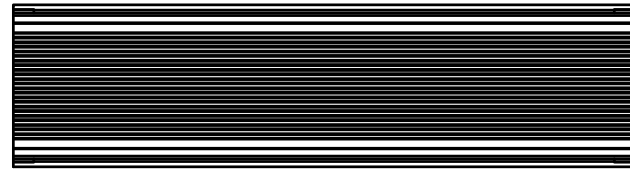

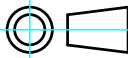
 株式会社タカチ電機工業 TAKACHI ELECTRONICS ENCLOSURE CO., LTD.			品名/Title ボディフレーム Body frame	 尺度/Scale 1 : 3.5
承認/Approved	検図/Checked	製図/Created	型番/Product number W200-H75-D287.8	
中根	王	岡本	作成日/Date 2017/07/18	3 / 4

フランジ付側板1
Flanged end panel 1

A-A (1:3)

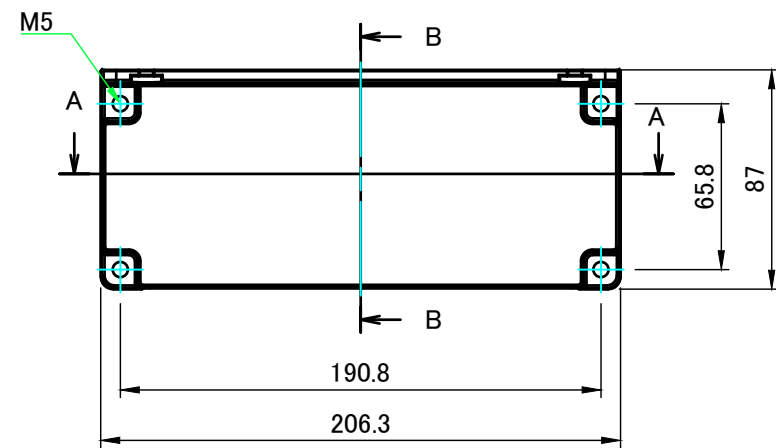
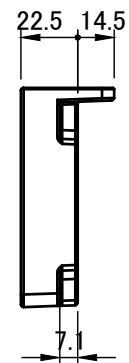

B-B (1:3)

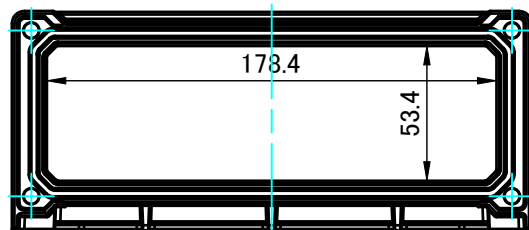
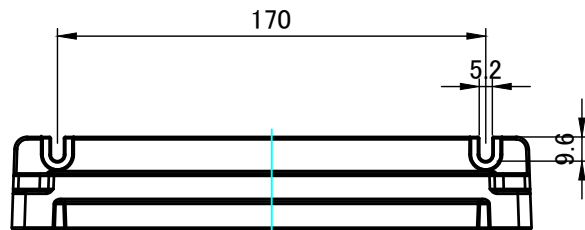
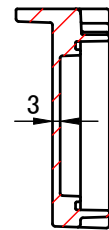

フランジ付側板2
Flanged end panel 2

C-C (1:3)

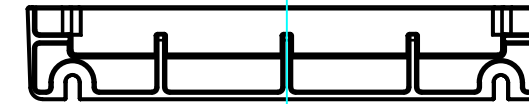

D-D (1:3)

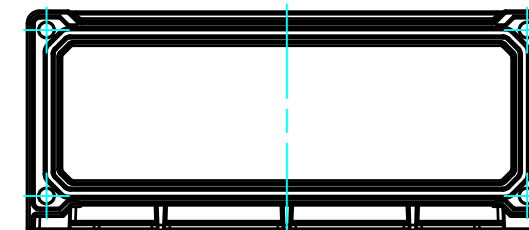
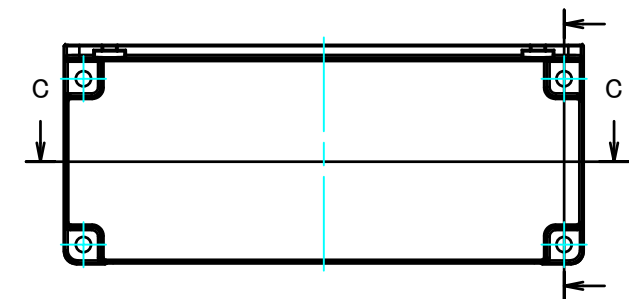
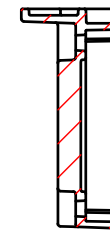

株式会社タカチ電機工業 TAKACHI ELECTRONICS ENCLOSURE CO., LTD.			品名/Title フランジ付側板 Flanged end panel	尺度/Scale 1:3
承認/Approved	検図/Checked	製図/Created	型番/Product number W200-H75	
中根	王	岡本	作成日/Date 2017/07/19	4 / 4