

■テクニカルデータ/Technical Data■	
保護等級/Protection class	IP67
温度範囲/Operating temperature	-40°C~+105°C
締め付けトルク/Recommended torque	1.0N・m(10kgf・cm)
※熱抵抗値/Thermal resistant rate	1.54°C/W

- ※熱抵抗値算出の条件/Thermal resistance test condition
- ・自然空冷/Ambient air cooling
  - ・フィンが地面に垂直で温度上昇60°Cの時/Heat-sink fins are set perpendicular to the ground with temperature at 60°C
  - ・押し出しがアルマイト品/Anodized extruded aluminium
  - ・全面素子/Heat source is applied on the opposite side (inner side) of the fins

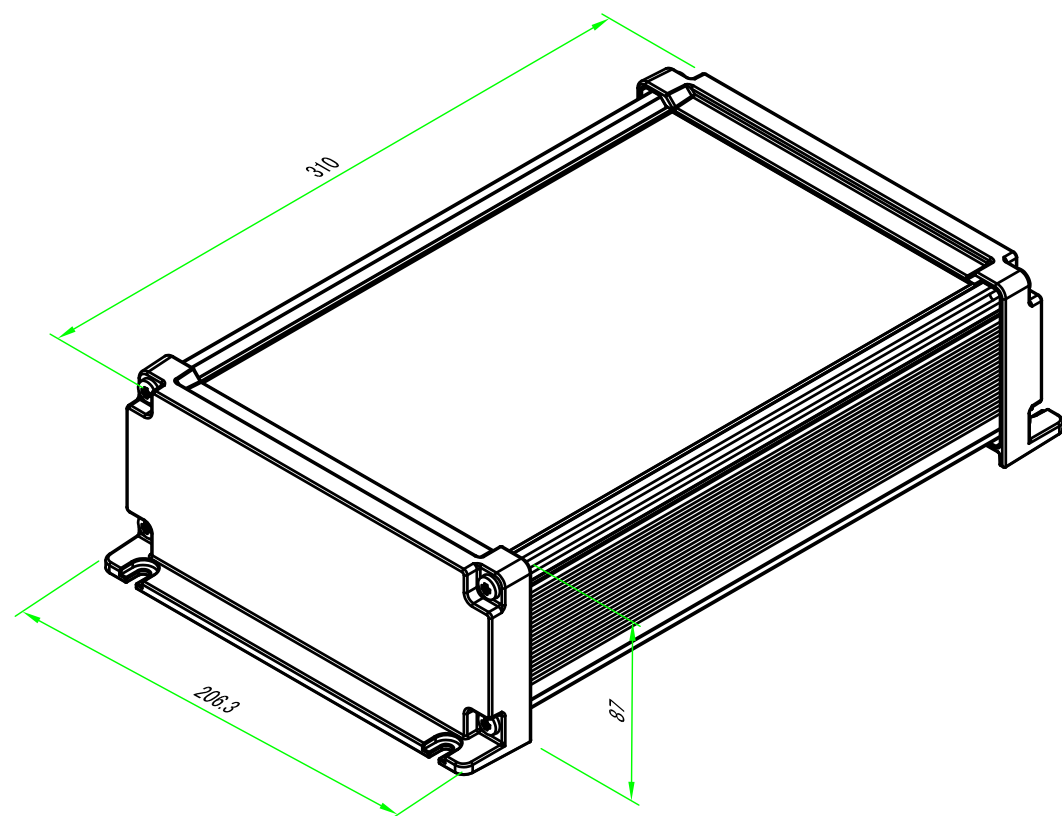

構成内容 / Components				
No.	名称 / Part name	数量 / Pcs	材質 / Material	色・表面処理 / Color・Finish
1	フランジ付側板/Flanged end panel	2	ADC12/Diecast aluminiumADC12	シルバー・ブラック・塗装(内面未処理)/Silver,black・Painted (unfinished inside)
2	ボディフレーム/Body frame	1	アルミ押出材/Extruded aluminium A6063S-T5	シルバー・ブラック・アルマイト&クリア塗装/Silver,black・Anodized & clear coated
3	シールドガスケット/Conductive gasket	2	導電性シリコン/Conductive silicone	ブラック/Black
4	取付ビス/Screw	8	ステンレス(ハイトM5×12)/Stainless steel	無処理/Unfinished

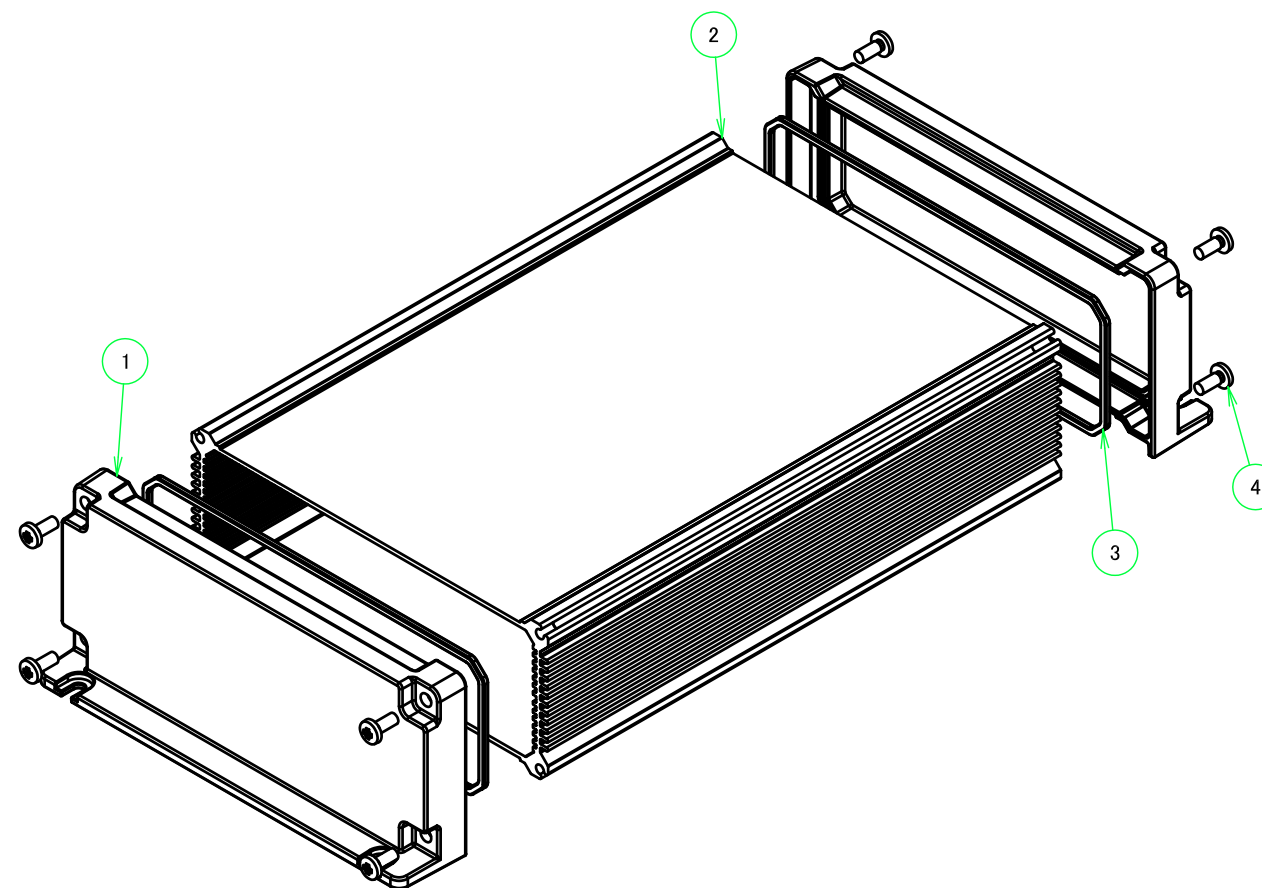

※側板内側は未塗装/The inside of the end panels are unpainted for shielding

色仕様(型番末尾□□)/Color type		
記号/Code	パネル/Panel	ボディフレーム/Body frame
SS	シルバー/Silver	シルバー/Silver
BS	ブラック/Black	シルバー/Silver
BB	ブラック/Black	ブラック/Black

<b>株式会社タカチ電機工業</b> TAKACHI ELECTRONICS ENCLOSURE CO., LTD.			品名/Title <b>フランジ足付防水・防塵アルミケース</b> <b>IP67 FLANGED ALUMINIUM ENCLOSURE</b>	尺度/Scale 1 : 3
承認/Approved	検図/Checked	製図/Created	型番/Product number <b>AW21-9-31E□□</b>	
中根	王	岡本	作成日/Date 2020/10/26	1 / 4

フランジ付側板1  
Flanged end panel 1

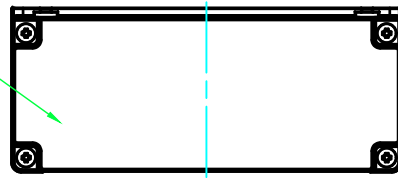

B-B (1:4)

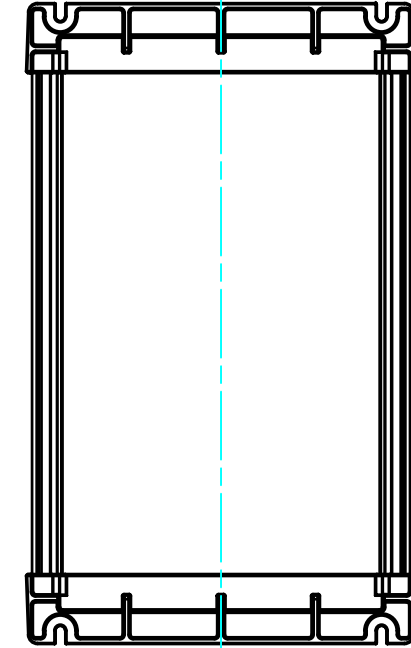
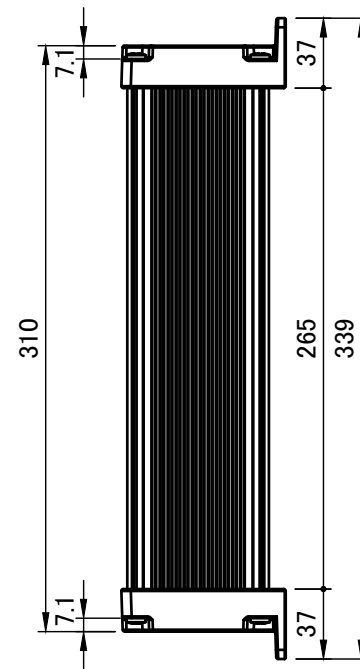
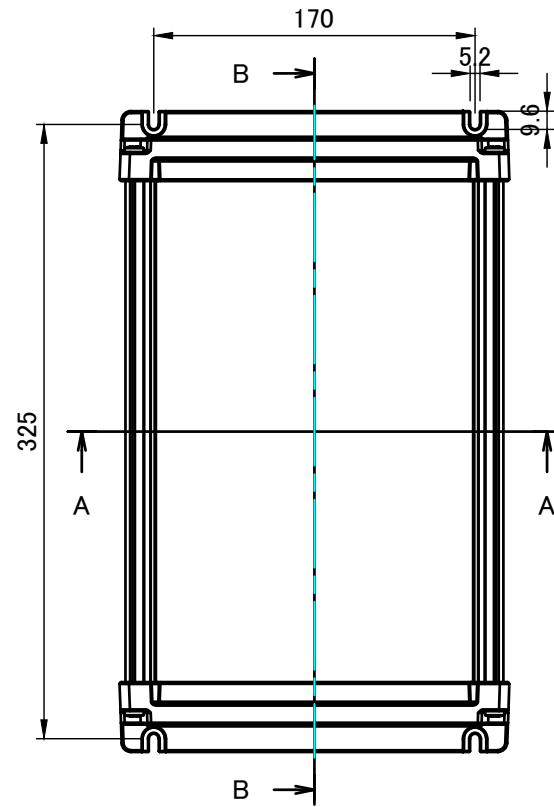
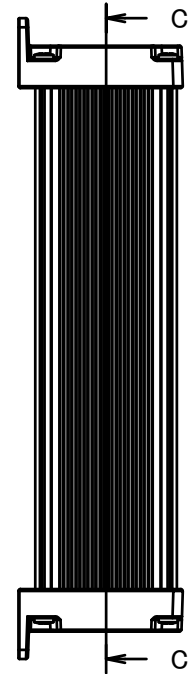
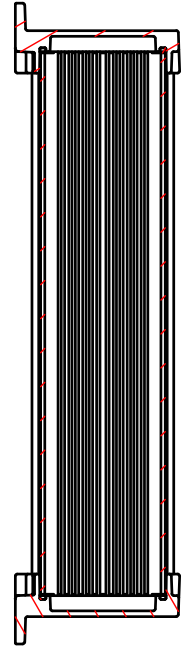

フランジ付側板2  
Flanged end panel 2

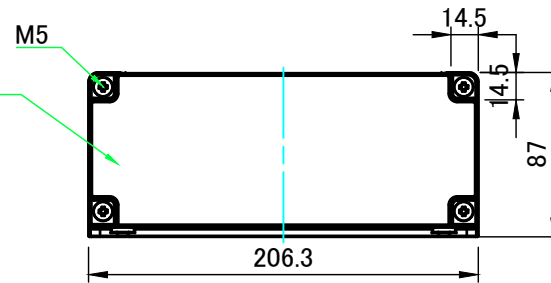

A-A (1:4)

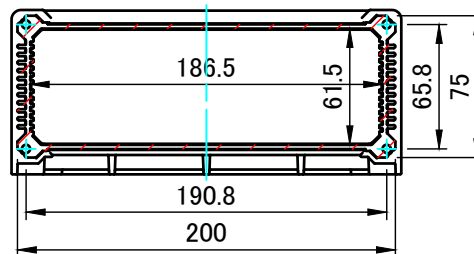

C-C (1:4)

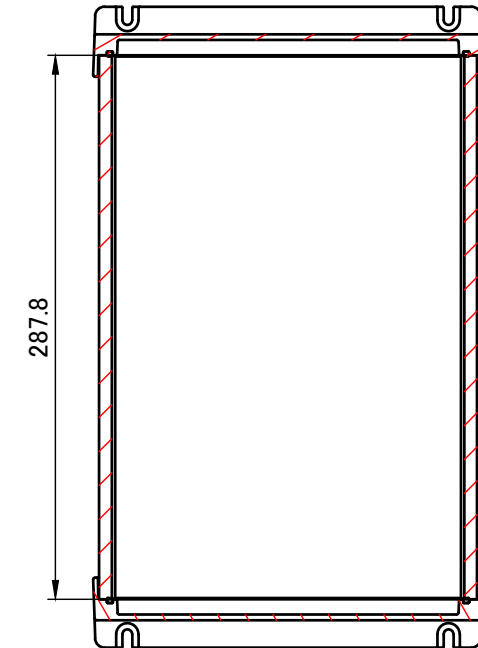

株式会社タカチ電機工業 TAKACHI ELECTRONICS ENCLOSURE CO., LTD.			品名/Title フランジ足付防水・防塵アルミケース IP67 FLANGED ALUMINIUM ENCLOSURE	尺度/Scale 1:4
承認/Approved	検図/Checked	製図/Created	型番/Product number AW21-9-31E□□	
中根	王	岡本	作成日/Date 2017/07/14	2 / 4

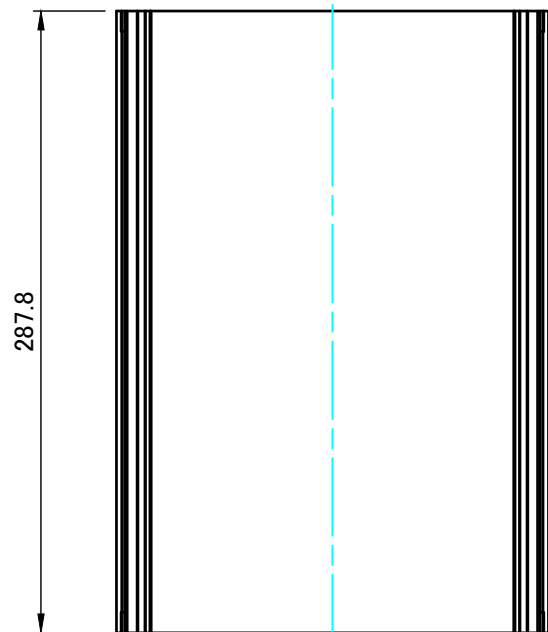
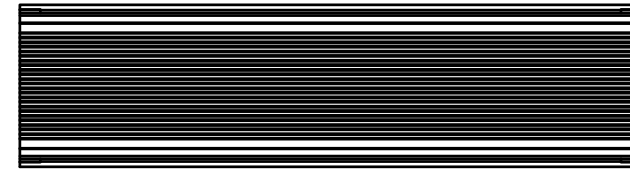
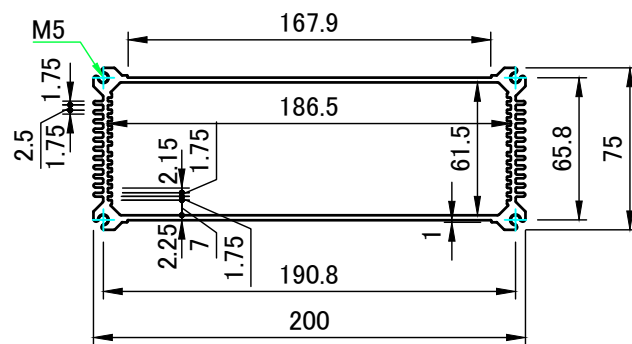
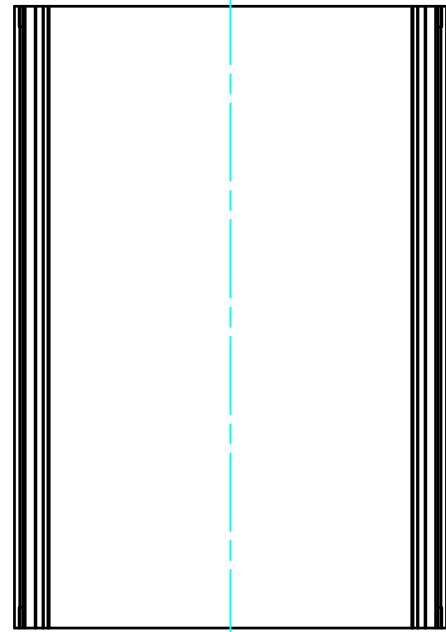
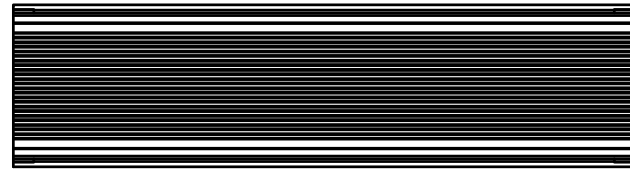

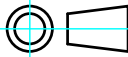
 株式会社タカチ電機工業 TAKACHI ELECTRONICS ENCLOSURE CO., LTD.			品名/Title ボディフレーム Body frame	 尺度/Scale 1 : 3.5
承認/Approved	検図/Checked	製図/Created	型番/Product number W200-H75-D287.8	
中根	王	岡本	作成日/Date 2017/07/18	3 / 4

フランジ付側板1  
Flanged end panel 1

A-A (1:3)

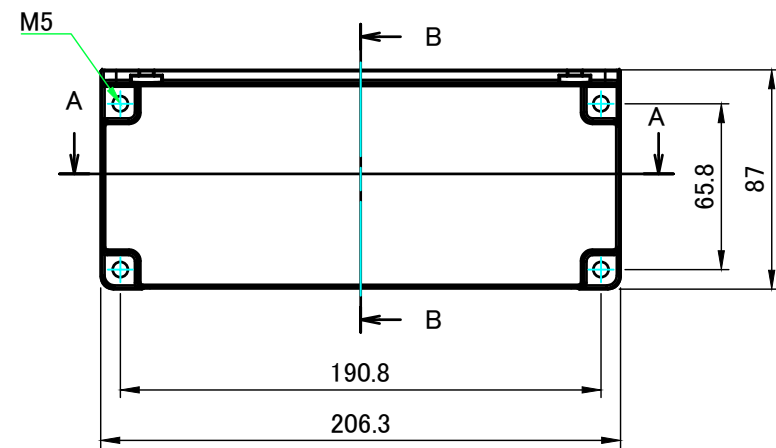
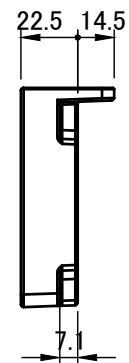

B-B (1:3)

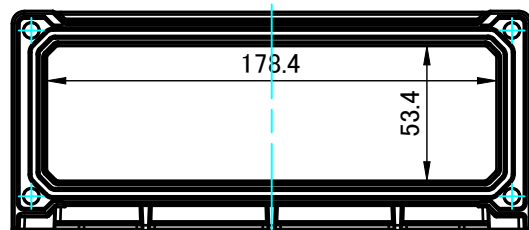
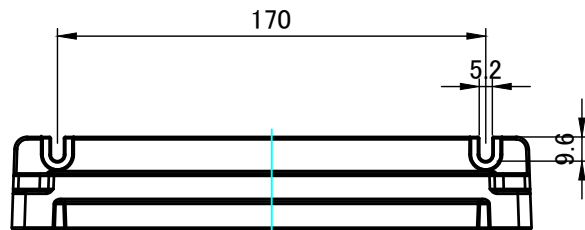
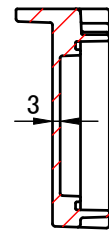

フランジ付側板2  
Flanged end panel 2

C-C (1:3)

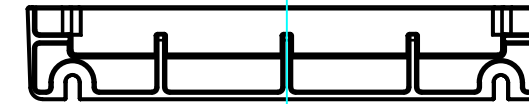

D-D (1:3)

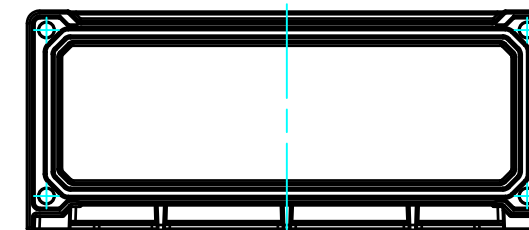
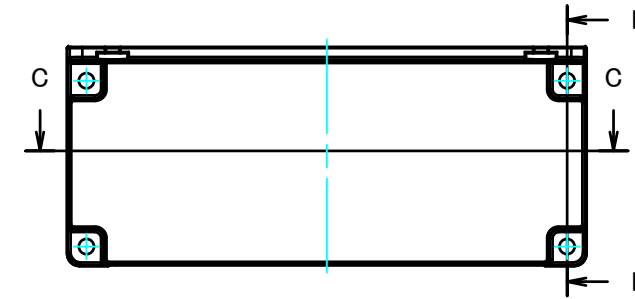
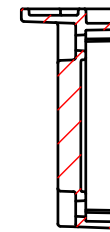

<b>株式会社タカチ電機工業</b> TAKACHI ELECTRONICS ENCLOSURE CO., LTD.			品名/Title <b>フランジ付側板</b> Flanged end panel	尺度/Scale 1:3
承認/Approved	検図/Checked	製図/Created	型番/Product number <b>W200-H75</b>	
中根	王	岡本	作成日/Date 2017/07/19	4 / 4